



This is a digital copy of a book that was preserved for generations on library shelves before it was carefully scanned by Google as part of a project to make the world's books discoverable online.

It has survived long enough for the copyright to expire and the book to enter the public domain. A public domain book is one that was never subject to copyright or whose legal copyright term has expired. Whether a book is in the public domain may vary country to country. Public domain books are our gateways to the past, representing a wealth of history, culture and knowledge that's often difficult to discover.

Marks, notations and other marginalia present in the original volume will appear in this file - a reminder of this book's long journey from the publisher to a library and finally to you.

### **Usage guidelines**

Google is proud to partner with libraries to digitize public domain materials and make them widely accessible. Public domain books belong to the public and we are merely their custodians. Nevertheless, this work is expensive, so in order to keep providing this resource, we have taken steps to prevent abuse by commercial parties, including placing technical restrictions on automated querying.

We also ask that you:

- + *Make non-commercial use of the files* We designed Google Book Search for use by individuals, and we request that you use these files for personal, non-commercial purposes.
- + *Refrain from automated querying* Do not send automated queries of any sort to Google's system: If you are conducting research on machine translation, optical character recognition or other areas where access to a large amount of text is helpful, please contact us. We encourage the use of public domain materials for these purposes and may be able to help.
- + *Maintain attribution* The Google "watermark" you see on each file is essential for informing people about this project and helping them find additional materials through Google Book Search. Please do not remove it.
- + *Keep it legal* Whatever your use, remember that you are responsible for ensuring that what you are doing is legal. Do not assume that just because we believe a book is in the public domain for users in the United States, that the work is also in the public domain for users in other countries. Whether a book is still in copyright varies from country to country, and we can't offer guidance on whether any specific use of any specific book is allowed. Please do not assume that a book's appearance in Google Book Search means it can be used in any manner anywhere in the world. Copyright infringement liability can be quite severe.

### **About Google Book Search**

Google's mission is to organize the world's information and to make it universally accessible and useful. Google Book Search helps readers discover the world's books while helping authors and publishers reach new audiences. You can search through the full text of this book on the web at <http://books.google.com/>

24503387359



LANE MEDICAL LIBRARY STAMFORD STOR  
D005 C29 1883 1  
The microscope and its revelations.

WOOD'S LIBRARY



OF  
STANDARD  
MEDICAL  
AUTHORS



\* W & W \*

✧LIBRARY✧  
OF  
Cooper Medical College

DATE \_\_\_\_\_  
NO. *101* SHELF *B.*  
GIFT OF \_\_\_\_\_

**LANE**

**MEDICAL**



**LIBRARY**

**LEVI COOPER LANE FUND**





*This book is the property of*  
**COOPER MEDICAL COLLEGE,**  
SAN FRANCISCO, CAL.  
*and is not to be removed from the*  
*Library Room by any person or*  
*under any pretext whatever.*



Vertical line on the left side of the page.



FRONTISPIECE.

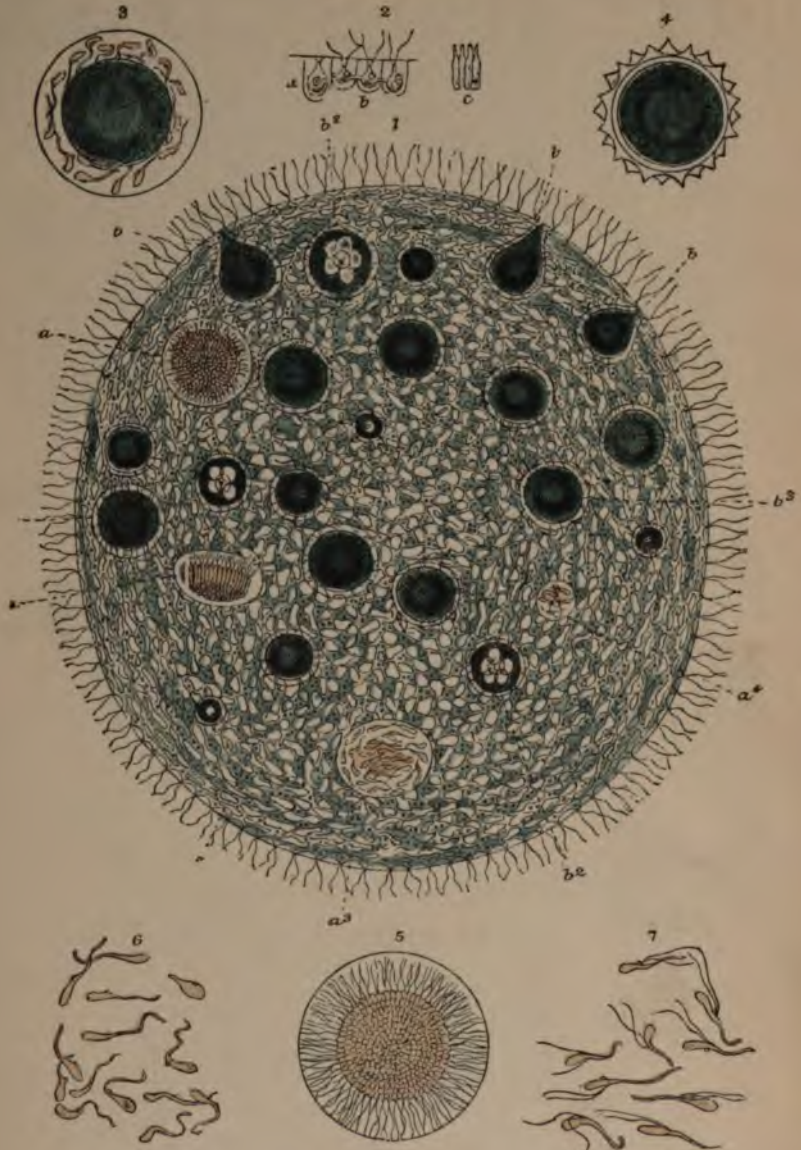

West, Norman & Co, chg. litho.

Volvox globator

THE  
MICROSCOPE

AND ITS  
REVELATIONS

BY  
WILLIAM B. CARPENTER, C.B. M.D. LL.D.

F.R.S. F.G.S. F.L.S.  
CORRESPONDING MEMBER OF THE INSTITUTE OF FRANCE,  
AND OF THE AMERICAN PHILOSOPHICAL SOCIETY,  
ETC., ETC.

SIXTH EDITION

ILLUSTRATED BY TWENTY-SIX PLATES  
AND FIVE HUNDRED WOOD ENGRAVINGS



*This book is the property of*  
COOPER MEDICAL COLLEGE,  
VOLUME I. SAN FRANCISCO, CAL.

*and is not to be removed from the  
Library Room by any person or  
under any pretext whatever.*

NEW YORK  
WILLIAM WOOD & COMPANY

56 & 58 LAFAYETTE PLACE

1883

At

LAUREL LIBRARY

D 205  
C 29  
1883  
v.1

## P R E F A C E.

---

THE rapid increase which has recently taken place in the use of the Microscope,—both as an instrument of scientific research, and as a means of gratifying a laudable curiosity and of obtaining a healthful recreation,—has naturally led to a demand for information, both as to the mode of employing the Instrument and its appurtenances, and as to the Objects for whose minute examination it is most appropriate. This information the Author has endeavored to supply in the following Treatise; in which he has aimed to combine, within a moderate compass, that information in regard to the use of his Instrument and its Appliances which is most essential to the working Microscopist, with such an account of the Objects best fitted for his study as may qualify him to comprehend what he observes, and thus prepare him to benefit Science whilst expanding and refreshing his own mind. The sale of five large Editions of this Manual, with the many spontaneous testimonies to its usefulness which the Author has received from persons previously unknown to him, justify the belief that it has not inadequately supplied an existing want; and in the preparation of the new Edition now called-for, therefore, he has found no reason to deviate from his original plan, whilst he has endeavored to improve its execution as to every point which seemed capable of amended treatment.

In his account of the various forms of Microscopes and Accessory Apparatus, the Author has not attempted to describe everything which is used in this country; still less, to go into minute details respecting the construction of foreign instruments. He is satisfied that in nearly all which relates both to the mechanical and the optical arrangements of their instruments, the chief English Microscope-makers are quite on a level with, if not in advance of, their Continental rivals; but, on the other hand, the latter have supplied instruments which are adequate to all the ordinary purposes of scientific research, at a lower price than such could until recently be obtained in this country. Several British makers, however, are now devoting themselves to the production of Microscopes which shall be really *good* though *cheap*; and the Author cannot but view with great satisfaction the extension of the manufacture in this direction. In the selection of Instruments for description which it was necessary for him to make, he trusts that he will be found to have done adequate jus-



tice to those who have most claim to honorable distinction. His principle has been to make mention of such Makers as have distinguished themselves by the introduction of any *new pattern* which he regards as deserving of special recommendation; those who have simply copied the patterns of others without essential modification, receiving no such recognition,—not because their instruments are *inferior*, but because they are *not original*.

In treating of the Applications of the Microscope, the Author has constantly endeavored to meet the wants of such as come to the study of the minute forms of Animal and Vegetable life with little or no previous scientific preparation, but desire to gain something more than a mere *sight* of the objects to which their observation may be directed. Some of these may perhaps object to the general tone of his work as too highly-pitched, and may think that he might have rendered his descriptions simpler by employing fewer Scientific terms. But he would reply that he has had much opportunity of observing among the votaries of the Microscope a desire for such information as he has attempted to convey; and that the use of scientific terms cannot be easily dispensed with, since there are no others in which the facts can be readily expressed. As he has made a point of explaining these in the places where they are first introduced, he cannot think that any of his readers need find much difficulty in apprehending their meaning.

The proportion of space allotted to the several departments has been determined not so much by their Scientific importance, as by their special interest to the *amateur* Microscopist; and the remembrance of this consideration will serve to account for much that might otherwise appear either defective or redundant. Thus, the Author has specially dwelt on those humble forms of Vegetable and Animal life, which the diligent collector is most likely to meet with, and which will fully reward his most attentive scrutiny. And he has endeavored, in his account of them, to interest his readers in the knowledge to be drawn from their study, as to those *fundamental phenomena of living action* which are now universally admitted to constitute the basis of Physiological science; thus giving to the portion of his Treatise which treats of Protophytic and Protozoic organisms, the character of a General Introduction to the study of Biology, which will, he hopes, prove specially useful to such as desire to follow this study into its higher walks. On the other hand, the Author has felt the necessity of limiting within a narrow compass his treatment of various important subjects which are fully discussed in Treatises expressly devoted to them (such, for example, as the structure of Insects, and Vertebrate Histology), in order that he might give more space to those on which no such sources of information are readily accessible. For the same reason, he has omitted all reference to the Embryonic Development of Vertebrated Animals,—a study that is second to none in scientific interest, but can only be advantageously taken up by the Microscopist who

has been trained to the pursuit. And he has found himself obliged to content himself with a mere indication of the new and important facts now being brought to our knowledge by Microscopic inquiry, in regard to the Deposits at present in progress on the bottom of the Deep Sea, the Mineral constitution of Sedimentary and Igneous Rocks, and other branches of Micro-Petrological inquiry, which are throwing a flood of new light on the past history of the Crust of the Earth.

It has been the Author's object throughout, to guide the possessor of a Microscope to the *intelligent* study of any department of Biology, which his individual tastes may lead him to follow-out, and his individual circumstances may give him facilities for pursuing. And he has particularly aimed to show, under each head, how small is the amount of trustworthy knowledge already acquired, compared with that which remains to be attained by the zealous and persevering student. Being satisfied that there is a large quantity of valuable *Microscope-power* at present running to waste in this country,—applied in such desultory observations as are of no service whatever to Science, and of very little to the mind of the observer,—he will consider himself well rewarded for the pains he has bestowed on the production and revision of this Manual, if it should be tend to direct this power to more systematic labors, in those fertile fields which only await the diligent cultivator to bear abundant fruit.

In all that concerns the *working* of the Microscope and its appurtenances, the Author has mainly drawn upon his own experience, which dates-back almost to the time when Achromatic Object-glasses were first constructed in this country. In his last Edition, he felt himself obliged by the demands which were made by Official duties upon his time and attention, to seek the aid of his friend Mr. H. J. Slack, in the preparation of the portion of the work specially relating to the Microscope and its appliances. But having now, at last, the command of his own time, he has preferred that this, like the rest of the Treatise, should be the expression of his own matured views; and has accordingly taken much trouble to acquaint himself thoroughly with such recent advances, alike in the theory and in the practice of Microscopy, as could be most fittingly introduced into it.

Accordingly, he has introduced at pp. 156–161 a concise account of the 'diffraction-theory' of Prof. Abbe, which has now given the complete *rationale* of the relation between the 'angular aperture' of Objectives and their 'resolving power.' And he has followed this up by a discussion of the question (pp. 161–173) whether the opening-out of the angular aperture to its extremest limits is the end to be specially aimed-at in the construction of Objectives for the highest kinds of Biological research; in other words, whether an Objective which resolves the most difficult Diatom tests, is on that account the one best suited for following the life-history of *Monad*, or for studying the development of a prob-

lematical *Bacillus*-organism. Having the misfortune to differ in opinion on this point from certain American Microscopists, who are distinguished by their expertness in the resolution of lined tests by Objectives of the largest angular aperture, and who enthusiastically advocate the use of such Objectives as the only powers to be trusted for Biological research, he has requested his friend, Mr. Dallinger (than whom there can be no higher authority on such a question), to give him the benefit of his experience thereon. And he is authorized by Mr. Dallinger to express his *entire concurrence* in the opinion uniformly upheld by the Author, that great 'resolving power' is only exceptionally needed in the most difficult Biological investigations; what is especially required for the study of *living and moving organisms* being such crisp and clear definition, good working distance, and considerable focal depth, as high-power Objectives of the widest aperture cannot afford. These qualities are so admirably combined in the 'dry' 1-35th of 'moderate angle' constructed to Mr. Dallinger's order by Messrs. Powell and Lealand, that he has been able to do work (of the kind just specified) with this Objective, which it would have been *simply impossible* for him to do with the oil-immersion 1-25th of the same makers, although this *far surpasses* their 1-35th in 'resolving' power.—When Prof. J. Edwards Smith, and those who side with him, shall have produced Biological work of anything like the same nature and quality as that of Mr. Dallinger, it will be interesting to know the results of their more extended experience.

On another point of great practical importance, the Author has thought it worth while to avail himself of Mr. Dallinger's unrivalled experience,—the utility of 'deep eye-piecing.' For he has seen with astonishment that the enthusiastic American advocates of the widest angles for Objectives of moderate power, are claiming for such objectives the advantage that they may be worked-up to any amount of amplification by sufficiently 'deep eye-piecing;' solid eye-pieces of *half* or even *a quarter* of an inch being now spoken-of as in ordinary use. He does not for a moment doubt that difficult lined tests *may* be thus shown; but that it is far less trying to the vision, when exercised *in continuous work*, to gain the needed amplification by a *high* Objective and *shallow* Eye-piece, than by a *low* Objective (however wide its angle) and *deep* Eye-piece, experience long ago satisfied him. Not having thus exercised his eyes, however, upon objects requiring the high amplifications used by Mr. Dallinger, he was fully prepared to submit his own judgment on this question to that of a gentleman who has so well earned his title to pronounce an authoritative verdict upon it; but, so far from having in the least to give way, the Author finds himself supported by Mr. D. in the most emphatic way. For he learns, not only that Mr. D.'s experience in the study of the most difficult Biological objects satisfies him of the immense superiority of the *highest* Objective that admits of good working distance, combined with a *low* Eye-piece, over the 'strained amplification' given

by a 4-10ths, a 1-4th, or even a 1-8th, with deep eye-pieces; but that Mr. D. is satisfied that if he had *tried* to do the work of the last ten years on the latter plan, "he would be now blind, instead of possessing as good and sensitive a sight as he had ten years ago." As it has been politely suggested by an American controversialist, that the Author's inability to appreciate the supreme value of wide aperture may be due to the senile deterioration of his vision, the Author is happy to be able to state that,—thanks to his habit of using shallow Eye-pieces, and of never persisting in Microscope-work when he has felt visual fatigue,—his eyes are now as fit for Microscopy as they were when he began so to use them nearly half a century ago.

He has only to add that he has endeavored, by a careful and thorough revision of the entire Treatise, to render it as serviceable as possible to those for whom it is specially intended. Besides introducing a large amount of new matter into the first four chapters, he has entirely re-written Chap. V., so as to embody in it an account of those methods of Hardening, Staining, Imbedding, and Section-cutting, which have completely revolutionized many departments of Microscopic investigation. In the sections relating to the Protophytic forms of Vegetable life, much new matter has been introduced in regard so the *Schizomycetes* or *Bacterium* group, the *Myzomycetes*, and others of those curious organisms which occupy the border-ground between Vegetable and Animal life. So, again, in the section on the Protozoic forms of Animal life, large additions have been made under the heads of *Monerozoa*, *Rhizopoda*, *Infusoria* (especially the *flagellate* and *suctorial*), and *Radiolaria*; and the section on *Sponges* has been entirely re-written. Some important additions have also been made (Chap. XXI.) in regard to the applications of the Microscope to Geological inquiry.—In many other instances, references have been made to the best sources of information upon recent discoveries of interest, which a due regard to the necessary limits of his book made it requisite for the Author to dismiss with a mere mention.

No fewer than fifty new Wood-engravings have been added (for the use of eleven of which the Author is indebted to the Council of the Linnæan Society), besides the reproduction of Prof. Cohn's beautiful Plate of *Volvox*, which now forms the Frontispiece.

To such as feel inclined to take up the use of the "Microscope as a means of healthful and improving occupation for their unemployed hours, the Author would offer this word of encouragement,—that, notwithstanding the number of recruits continually being added to the vast army of Microscopists, and the rapid extension of its conquests, the inexhaustibility of Nature is constantly becoming more and more apparent; so that no apprehension need arise that the Microscopist's researches can ever be brought to a stand *for want of an object!*

LONDON, May, 1861.

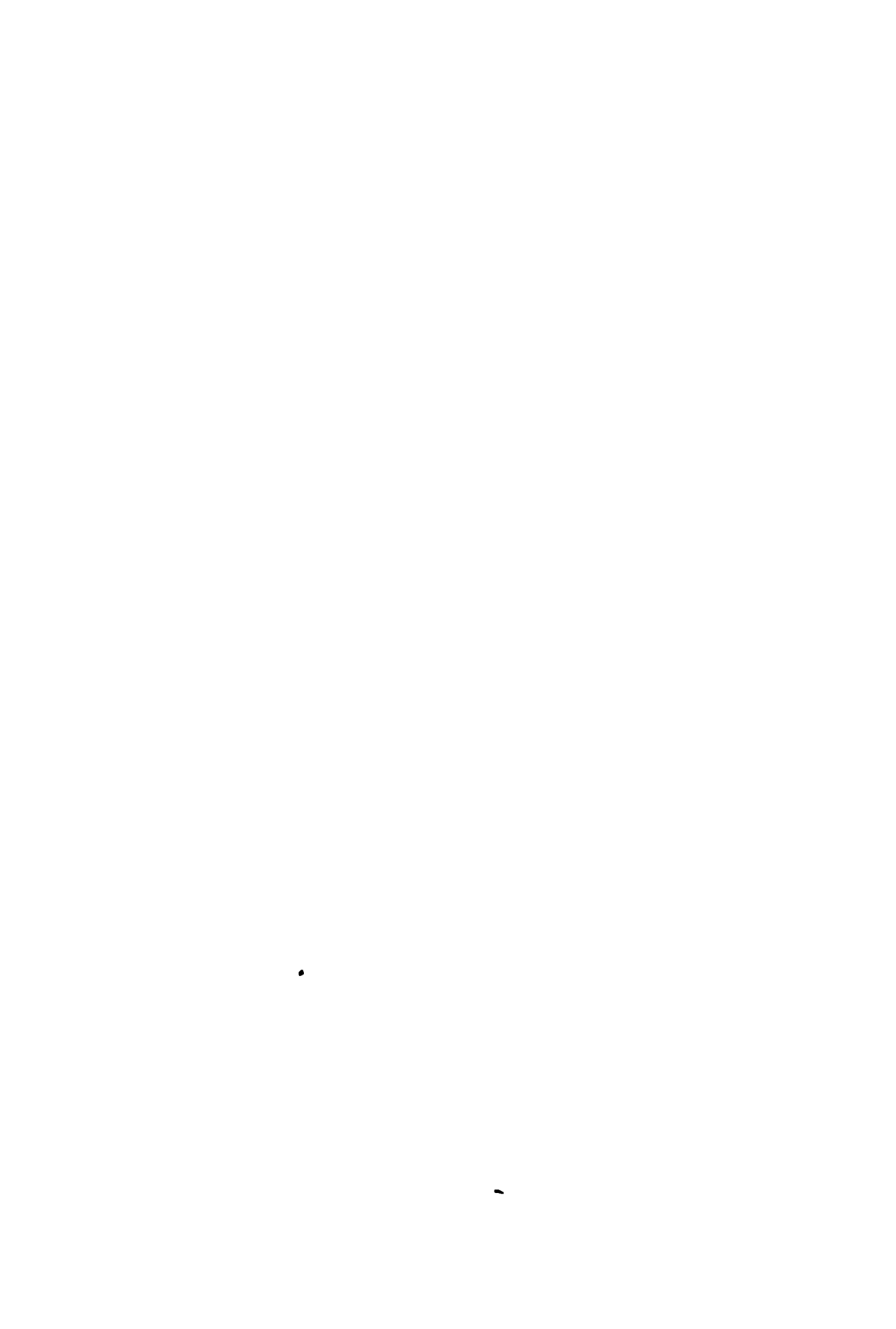

# TABLE OF CONTENTS.

## CHAPTER I.

### OPTICAL PRINCIPLES OF THE MICROSCOPE.

	PAGE
Laws of Refraction:—Spherical and Chromatic Aberration, . . . . .	1
Construction of Achromatic Objectives, . . . . .	11
Immersion Systems, . . . . .	16
Simple Microscope, . . . . .	18
Compound Microscope, . . . . .	22
Principles of Binocular Vision, . . . . .	25
Stereoscopic Binocular Microscopes, . . . . .	27
Nachet's, . . . . .	28
Wenham's, . . . . .	29
Stephenson's, . . . . .	31
Tolles' Binocular Eyepiece, . . . . .	33
Nachet's Stereo-pseudoscopic Binocular, . . . . .	33
Special value of Stereoscopic Binoculars, . . . . .	35

## CHAPTER II.

### CONSTRUCTION OF THE MICROSCOPE.

	PAGE		PAGE
GENERAL PRINCIPLES, . . . . .	40	Baker's (Erecting ditto), . . . . .	65
SIMPLE MICROSCOPES, . . . . .	43	<i>Second Class Microscopes</i> , . . . . .	67
Ross's, . . . . .	43	Powell and Lealand's, . . . . .	67
Quekett's Dissecting, . . . . .	45	Beck's (Popular Binocular), . . . . .	68
Siebert & Kraft's Dissecting, . . . . .	46	Collins's (Harley Binocular), . . . . .	70
Laboratory Dissecting, . . . . .	47	Swift's (Challenge), . . . . .	71
Beck's Dissecting and Nachet's		Browning's Smaller Stephenson	
Binocular, . . . . .	48	Binocular, . . . . .	73
Field's Dissecting and Mount-		<i>First Class Microscopes</i> , . . . . .	73
ing, . . . . .	49	Ross's (Ross Model), . . . . .	73
COMPOUND MICROSCOPES, . . . . .	51	Ross's (Jackson-Zentmayer), . . . . .	75
<i>Educational Microscopes</i> , . . . . .	53	Powell and Lealand's, . . . . .	77
Field's, . . . . .	53	Beck's, . . . . .	77
Crouch's, . . . . .	53	Beck's (Improved), . . . . .	80
Parkes's, . . . . .	53	<i>Microscopes for Special Purposes</i> , . . . . .	80
<i>Students' Microscopes</i> , . . . . .	55	Beale's Pocket and Demonstrat-	
Baker's, . . . . .	59	ing, . . . . .	81
Collins's, . . . . .	59	Baker's Travelling, . . . . .	81
Pillischer's (International), . . . . .	59	Swift's Portable, . . . . .	82
Ross's (Zentmayer), . . . . .	61	Nachet's Chemical, . . . . .	82
Wale's (New Working), . . . . .	61	<i>Non-Stereoscopic Binoculars</i> , . . . . .	84
Nachet's, . . . . .	63	Powell and Lealand's, . . . . .	85
Browning's (Rotating), . . . . .	65	Wenham's, . . . . .	85
Crouch's (Binocular), . . . . .	65		

FRONTISPIECE.

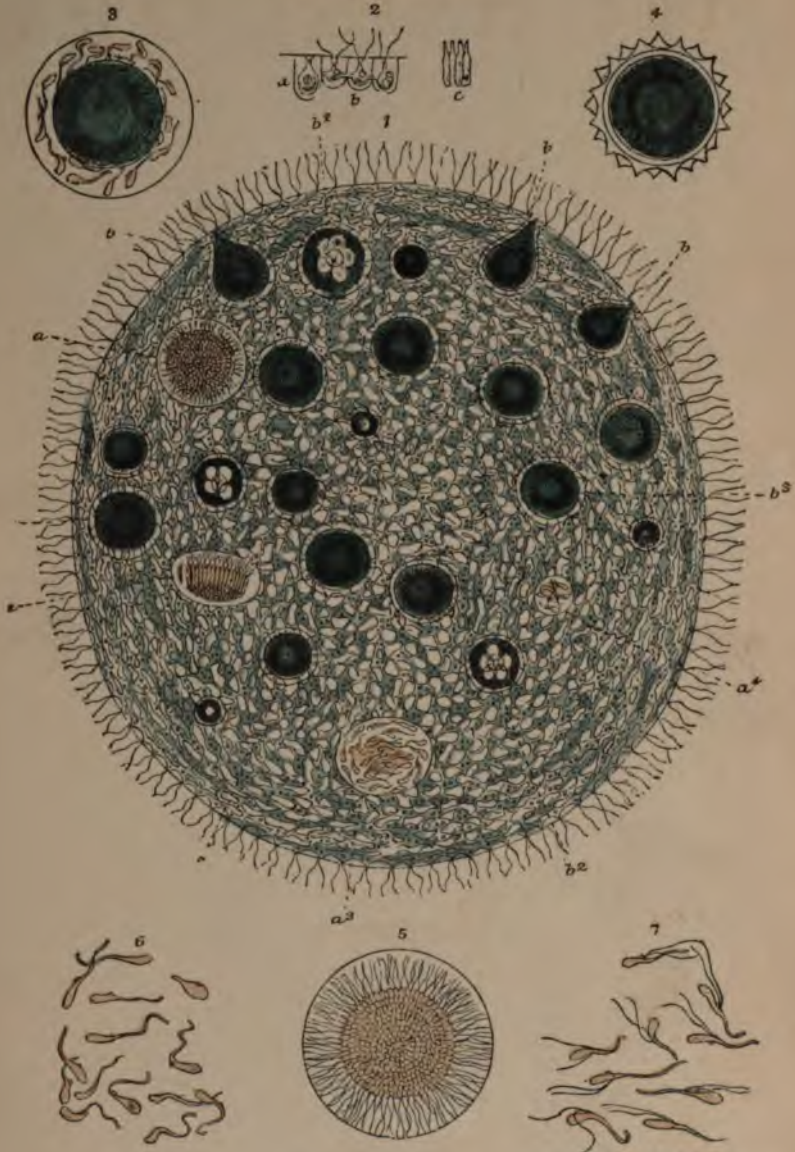

West, Norman & Co. del. lith.

Volvox globator

THE  
MICROSCOPE

AND ITS  
REVELATIONS

BY  
WILLIAM B. CARPENTER, C.B. M.D. LL.D.

F.R.S. F.G.S. F.L.S.  
CORRESPONDING MEMBER OF THE INSTITUTE OF FRANCE,  
AND OF THE AMERICAN PHILOSOPHICAL SOCIETY,  
ETC., ETC.

SIXTH EDITION

ILLUSTRATED BY TWENTY-SIX PLATES  
AND FIVE HUNDRED WOOD ENGRAVINGS



*This book is the property of*  
COOPER MEDICAL COLLEGE,  
VOLUME I. SAN FRANCISCO, CAL

*and is not to be removed from the  
Library Room by any person or  
under any pretext whatever.*

NEW YORK  
WILLIAM WOOD & COMPANY

56 & 58 LAFAYETTE PLACE

1883  
A





# THE MICROSCOPE.

## CHAPTER I.

### OPTICAL PRINCIPLES OF THE MICROSCOPE.

#### 1. *Laws of Refraction:—Spherical and Chromatic Aberration.*

1. ALL Microscopes in ordinary use, whether *Simple* or *Compound*, depend for their magnifying power on that influence exerted by Lenses, in altering the course of the rays of light passing through them, which is termed *Refraction*. This influence takes place in accordance with the two following laws, which are fully explained and illustrated in every elementary treatise on Optics:—

I. A ray of light passing from a rarer into a denser medium, is refracted *towards* a line drawn perpendicularly to the plane which divides them; and *vice versa*.

II. The *sines* of the angles of *incidence* and *refraction* (that is, of the angles which the ray makes with the perpendicular *before* and *after* its refraction) bear to one another a constant ratio for each substance, which is known as its *index of refraction*.

Thus the ray  $E O$  (Fig. 1) passing from Air into Water, will not go on to  $F$ , but will be refracted towards the line  $C C'$  drawn perpendicularly to the surface  $A B$  of the water, so as to take the direction  $O W$ . If it pass into Glass, it will undergo a greater refraction, so as to take the direction  $O G$ . And if it pass into Diamond, the change in its course will be so much greater, that it will take the direction  $O D$ . The angle  $E O C$  is termed the 'angle of incidence;' whilst the angles  $W O C'$ ,  $G O C'$ , and  $D O C'$  are the 'angles of refraction.' And whether the angle of incidence be large or small, its sine  $e e'$  bears a constant ratio in each case to the sine  $w w'$  or  $g g'$  or  $d d'$ , of the angle of refraction; and this ratio is what is termed the 'index of refraction.'

The 'index of refraction' is determined for different media by the amount of the refractive influence which they exert upon rays passing into them, not from air, but from a vacuum; and in expressing it, the sine of the angle of refraction is considered as the *unit*, to which that of the angle of incidence bears a fixed relation. Thus when we say that the 'index of refraction' of Water is 1.336, we mean that the sine  $e e'$  of the angle of incidence  $E O C$  of a ray passing into water from a vacuum, is to the sine  $w w'$  of the angle of refraction  $w O C'$ , as 1.336 to 1, or almost

exactly as  $1\frac{1}{2}$  to 1, or as 4 to 3. So, again, the index of refraction for (flint) Glass, being about 1.6, we mean that the sine  $e e'$  of the angle of incidence of a ray  $E O C$  passing into Glass from a vacuum, is to the sine of  $g g'$  the angle of refraction  $G O C'$ , as 1.6 to 1, or as 8 to 5. So in the

FIG. 1.

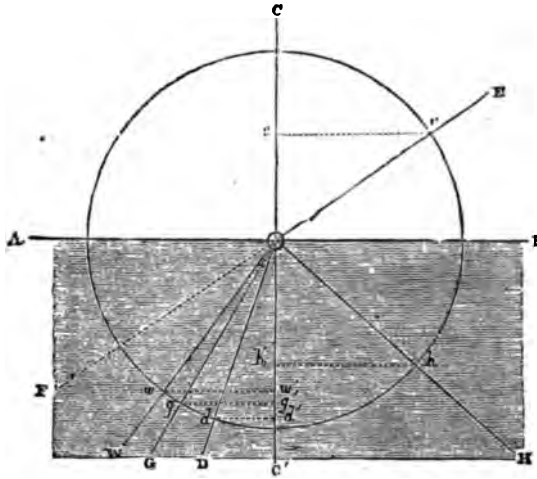

case of Diamond, the sine  $e e'$  is to the sine  $d d'$  as 2.439 to 1, or almost exactly as  $2\frac{1}{2}$  to 1, or as 5 to 2. Thus, the angle of incidence being given, the angle of refraction may be always found by *dividing* the sine of the former by the 'index of refraction,' which will give the sine of the latter. In accordance with these laws, a ray of light passing from one medium to another *perpendicularly* to the surface which divides them undergoes no refraction; and of several rays entering at different

angles, those nearer the perpendicular are refracted less than those more inclined to the refracting surface.—When a pencil of rays, however, impinges on the surface of a denser medium (as when rays passing through Air fall upon Water or Glass), some of the incident rays are reflected from that surface, instead of entering it and undergoing refraction; and the proportion of these rays increases with the *increase* of their obliquity. Hence there is a *loss of light* in every case in which pencils of rays are made to pass through lenses or prisms: and this diminution in the brightness of the image formed by refraction will bear a proportion, on the one hand, to the number of surfaces through which the rays have had to pass; and, on the other, to the degree of obliquity of the incident rays, and to the difference of the refractive powers of the two media. Hence, in the passage of a pencil of rays out of Glass into Air, and then from Air into Glass again, the loss of light is much greater than it is when some medium of higher refractive power than air is interposed between the two glass surfaces; and advantage is taken of this principle in the construction of Achromatic objectives for the Microscope, the component lenses of each pair or triplet (§ 14) being cemented together by Canada Balsam; as also in the interposition of Water or some other liquid between the covering-glass of the object and the front lens of the objective, in the 'immersion lenses' now coming into general use (§ 19). On the other hand, advantage is taken of the partial reflection of rays passing from air into glass at an oblique angle to the surface of the latter, in the construction of the ingenious (non-stereoscopic) Binoculars of Messrs. Powell and Lealand and of Mr. Wenham (§ 81).

2. When, on the other hand, a ray,  $w o$ , emerges from a dense medium into a rare one, instead of following the straight course, it is bent *from* the perpendicular according to the same ratio; and to find the course of the emergent ray, the sine of the angle of incidence must be *multiplied* by the 'index of refraction,' which will give the sine of the

angle of refraction. And thus, when an emergent ray falls very obliquely upon the surface of the denser medium, the refraction which it would sustain in passing forth into the rarer medium, tending as it does to deflect it still farther from the perpendicular, becomes so great that the ray cannot pass out at all, and is reflected back from the plane which separates the two media, into the one from which it was emerging. This *internal reflection* will take place whenever the product of the sine of the angle of incidence, multiplied by the index of refraction, exceeds the sine of  $90^\circ$ , which is the radius of the circle; and therefore the 'limiting angle,' beyond which an oblique ray suffers internal reflection, varies for different substances in proportion to their respective indices of refraction. Thus, the index of refraction of Water being 1.336, no ray can pass out of it into a vacuum,<sup>1</sup> if its angle of incidence exceed  $48^\circ 28'$ , since the sine  $h h'$  of that angle,  $h o c'$ , multiplied by 1.336 equals the radius; and, in like manner, the 'limiting angle' for Flint-glass, its index of refraction being 1.60, is  $38^\circ 41'$ .—This fact imposes certain limits upon the performance of microscopic Lenses, since of the rays which would otherwise pass out from glass into air all the more oblique are kept back; whilst, on the other hand, it enables the Optician to make most advantageous use of glass Prisms for the purpose of *reflection*, the proportion of the light which they throw back being much larger than that returned from the best polished metallic surfaces, and the brilliancy of the reflected image being consequently greater. Such prisms are of great value to the Microscopist for particular purposes, as will hereafter appear. (§§ 33–38.)

3. The Lenses employed in the construction of Microscopes are chiefly *convex*; those of the opposite kind, or *concave*, being only used to make certain modifications in the course of the rays passing through convex lenses, whereby their performance is rendered more exact (§§ 11, 13).—It is easily shown to be in accordance with the laws of refraction already cited, that when a bundle of parallel rays, passing through air, impinges upon a spherical surface of glass, these rays will be made to converge. For the perpendicular to every point of that surface is the radius drawn from the centre of the sphere to that point, and prolonged through it; so that, whilst any ray which coincides with the radial perpendicular will go on without change in its course towards the centre of the sphere; every ray which falls upon the spherical surface at an inclination to its prolonged radius undergoes refraction in a degree proportionate (as already explained) to that inclination. And the effect upon the whole bundle will be such, that its rays will be caused to meet at a point, called the *focus*, some distance beyond the centre of curvature.—This effect will be somewhat modified by the passage of the rays into air again through a *plane* surface of glass, perpendicular to the axial ray (Fig. 2); and a lens of this description, called a *plano-convex* lens, will hereafter be shown to possess properties which render it very useful in the construction of Microscopes.—But if, instead of passing through a plane surface, the rays re-enter the air through a second *convex* surface, turned in the opposite direction, as in a *double-convex* lens, they will be made to converge

<sup>1</sup> The reader may easily make evident to himself the internal reflection of Water, by nearly filling a wine-glass with water, and holding it at a higher level than his eye, so that he sees the surface of the fluid obliquely from beneath.—no object held above the water will then be visible through it, if the eye be placed beyond the limiting angle; whilst the surface itself will appear as if silvered, through its reflecting back to the eye the light which falls upon it from beneath.

still more. This will be readily comprehended when it is borne in mind that the contrary direction of the second surface, and the contrary direction of its refraction (this being *from* the denser medium instead of *into*

FIG. 2.



Parallel rays, falling on a *plano-convex* lens of glass, brought to a focus at the distance of the diameter of its sphere of curvature; and conversely, rays diverging from that point, rendered parallel.

degree of curvature, but also upon the refracting power of the substance of which it may be formed; since the

FIG. 3.

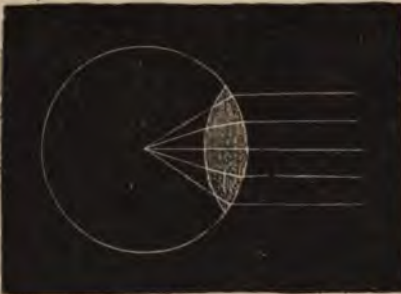

Parallel rays, falling on a *double-convex* lens, brought to a focus in the centre of its sphere of curvature: conversely, rays diverging from that point rendered parallel.

*two* convex surfaces (Fig. 3); and as this ratio almost exactly expresses the refractive power of ordinary crown or plate Glass, we may for all practical purposes consider the 'principal focus' (as the focus for parallel rays is termed) of a *double-convex* lens to be at the distance of its radius, that is, in the centre of curvature, and that of a *plano-convex* lens to be at the distance of twice its radius, that is, at the other end of the diameter of its sphere of curvature.

5. It is evident from what has preceded, that as a *Double-convex* lens brings parallel rays to a focus in its centre of curvature, it will on the other hand cause those rays which are diverging from that centre before they impinge upon it, to assume a parallel direction (Fig. 3); so that, if a luminous body be placed in the principal focus of a *double-convex* lens, its divergent rays, falling on one surface of the lens, as a *cone*, will pass forth from its other side as a *cylinder*. If, however, the rays which fall upon a *double-convex* lens be diverging from the farther extremity of the diameter of its sphere of curvature, they will be brought to a focus at an

it), antagonize each other; so that the second convex surface exerts an influence on the course of the rays passing through it, which is almost exactly equivalent to that of the first. Hence the focus of a *double-convex* lens will be at just half the distance, or (as commonly expressed) will be half the length of the focus of a *plano-convex* lens having the same curvature on one side (Fig. 3).

4. The distance of the Focus from the spherical surface will depend not merely upon its degree of curvature, but also upon the refracting power of the substance of which it may be formed; since the *lower* the index of refraction, the *less* will the oblique rays be deflected towards the axial ray, and the *more remote* will be their point of meeting; and conversely, the *greater* the refractive index, the *more* will the oblique rays be deflected towards the axial ray, and the *nearer* will be their point of convergence. A lens made of any substance whose index of refraction is 1.5, will bring parallel rays to a focus at the distance of its *diameter* of curvature, after they have passed through *one* convex surface (Fig. 2), and at the distance of its *radius* of curvature, after they have passed through



equal distance on the other side of the lens (Fig. 4); but the more the point of divergence is approximated to the centre or principal focus, the farther removed from the other side will be the point of convergence (Fig. 5), until, the point of divergence being *at* the centre, there is no convergence at all, the rays being merely rendered parallel (Fig. 3); whilst if the point of divergence be *beyond* the diameter of the sphere of curvature, the point of convergence will be within it (Fig. 5). The farther removed the point of divergence, the more nearly will the rays approach the parallel direction: until, at length, when the object is very distant, its rays in effect become parallel, and are brought together in the principal focus (Fig. 3). If, on the other hand, the point of divergence be *within* the principal focus, they will neither be brought to converge, nor be rendered parallel, but will diverge in a diminished degree (Fig. 6). And conversely, if rays *already converging* fall upon a double-convex lens, they will be brought together at a point nearer to it than its centre of curvature (Fig. 6).—The same principles apply equally to a plano-convex lens; allowance being made for the double distance of its principal focus. They also apply to a lens whose surfaces have different curvatures; the principal focus of such a lens being found by multiplying the radius of one surface by the radius of the other, and dividing this product by half the sum of the same radii.—The rules by which the foci of convex lenses may be found, for rays of different degrees of convergence and divergence, will be found in works on Optics.

6. The refracting influence of *concave* lenses will evidently be precisely the opposite of that of convex. Rays which fall upon them in a parallel direction, will be made to *diverge* as if from the principal focus, which is here called the *negative focus*. This

FIG. 4.



Rays diverging from the farther extremity of one diameter of curvature of a *double-convex* lens, brought to a focus at the same distance on the other side.

FIG. 5.



Rays diverging from points more distant than the principal focus of a *double-convex* lens on either side, brought to a focus beyond it; the focus of convergence being within the diameter of curvature, if the focus of divergence be beyond it; and *vice versa*.

FIG. 6.



Rays already converging, brought together by a *double-convex* lens at a point nearer than its principal focus; and rays diverging from a point within its principal focus, still diverging, through in a diminished degree.

will be for a plano-concave lens, at the distance of the diameter or the sphere of curvature; and for a double-concave, in the centre of that sphere. In the same manner, rays which are converging to such a degree, that, if uninterrupted, they would have met in the principal focus, will be rendered parallel; if converging more they will still meet, but at a greater distance; and if converging less, they will diverge as from a negative focus at a greater distance than that for parallel rays. If already diverging, they will diverge still more, as from a negative focus nearer than the principal focus; but this negative focus will approach the principal focus, in proportion as the distance of the point of divergence is such that the direction of the rays approaches the parallel.

7. If a lens be convex on one side and concave on the other, forming what is called a *meniscus*, its effect will depend upon the proportion between the two curvatures. If they are equal, as in a watch-glass, scarcely any perceptible effect will be produced; if the *convex* curvature be the greater, the effect will be that of a less powerful convex lens; and if the *concave* curvature be the more considerable, it will be that of a less powerful concave lens. The focus of convergence for parallel rays in the first case, and of divergence in the second, may be found by dividing the product of the two radii by half their difference.

8. Hitherto we have considered only the effects of lenses either on a 'bundle' of parallel rays, or on a 'pencil' of rays issuing from a single luminous point, and that point situated in the line of its axis. If the point be situated above the line of its axis, the focus will be below it, and *vice versa*. The surface of every luminous body may be regarded as comprehending an infinite number of such points, from every one of which a pencils of rays proceeds, to be refracted in its passage through a lens according to the laws already specified; so that a complete but *inverted* image or picture of the object is formed upon any surface placed in the focus and adapted to receive the rays. It will be evident from what has gone before, that if the object be placed at twice the distance of the principal focus, the image, being formed at an equal distance on the other side of the lens (§ 5), will be of the same dimensions with the object: whilst, on the other hand, if the object (Fig. 7, *a b*) be nearer the lens, the

FIG. 7.

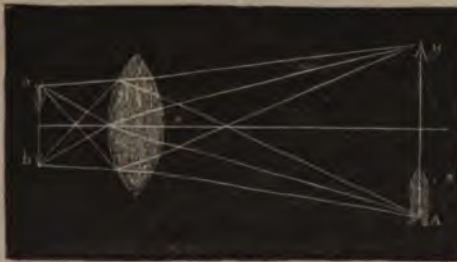

Formation of Images by Convex Lenses.

image *AB* will be farther from it, and of larger dimensions; but if the object *AB* be farther from the lens, the image *ab* will be nearer to it, and smaller than itself. Further, it is to be remarked that the larger the image in proportion to the object, the less bright will it be, because the same amount of light has to be spread over a greater surface; whilst an image that is smaller than the

object will be more brilliant in the same proportion.

9. A knowledge of these general facts will enable the learner to understand the ordinary action of the Microscope; but the instrument is subject to certain optical imperfections, the mode of remedying which cannot be comprehended without an acquaintance with their nature. One of these imperfections results from the unequal refraction of the rays



which pass through lenses whose curvatures are equal over their whole surfaces. If the course of the rays passing through an ordinary convex lens be carefully laid down (Fig. 8), it will be found that they *do not all meet exactly* in the foci already stated; but that the focus  $F$  of the rays  $AB, AB$ , which have passed through the marginal portion of the lens, is much closer to it than that of the rays  $a b, a b$ , which are nearer the line of its axis. This may be shown experimentally, by 'stopping out' either the central or the marginal portion of the lens; for it will then be



Diagram illustrating Spherical Aberration.

found that the rays which are allowed to pass through the latter alone form a distinct image at  $F$ ; whilst those which pass through the former alone form a distinct image at  $f$ . Hence, if the whole aperture be in use, and a screen be held in the focus  $F$  of the marginal portion of the lens, the rays which have passed through its central portion will be stopped by it before they have come to a focus; whilst, if the screen be carried back into the focus  $f$  of the latter, the rays which were most distant from the axis will have previously met and crossed, so that they will come to it in a state of divergence, and will pass to  $c$  and  $d$ . In either case, therefore, the image will have a certain degree of indistinctness; and there is no one point to which *all* the rays can be brought by a single lens of spherical curvature. The distance  $Ff$ , between the focal points of the central and of the peripheral rays of any lens, is termed its *Spherical Aberration*.—It is obvious that the desired effect could be produced by such an increase of the curvature round the centre of the lens, and such a diminution of the curvature towards its circumference, as would make the two foci coincident. And the requisite conditions may be theoretically fulfilled by a single lens, one of whose surfaces, instead of being spherical, is a portion of an ellipsoid or hyperboloid of certain proportions. But the difficulties in the way of the mechanical execution of lenses of this description are such, that for practical purposes this plan of construction is altogether unavailable; besides which, their performance would only be perfectly accurate for parallel rays.

10. Various means have been devised for reducing the aberration of lenses of spherical curvature. In the first place, it may be kept down by using ordinary lenses in the most advantageous manner. Thus the aberration of a Plano-convex lens whose convex side is turned towards parallel rays, is only  $\frac{1}{10}$ ths of its thickness; whilst, if its plane side be turned towards them, the aberration is  $4\frac{1}{2}$  times the thickness of the lens. Hence, when a plano-convex lens is used to form an image by bringing to a focus parallel or slightly-diverging rays from a distant object, its *convex* surface should be turned towards the object; but, when it is used to render parallel the rays which are diverging from a very near object, its *plane* surface should be turned towards the object. The single lens having the least spherical aberration, is a Double-convex whose radii are as *one to six*: when the flattest face of this is turned towards parallel rays, the aberration is nearly  $3\frac{1}{2}$  times its thickness; but when its most convex side receives or transmits them, the aberration is only  $\frac{1}{10}$ ths of its thickness.—Spherical Aberration is further diminished by reducing



the aperture or working-surface of the lens, so as to employ only the rays that pass through its central part, which, if sufficiently small in proportion to the whole sphere, will bring them all to nearly the same focus. Such a reduction is made in the Object-glasses of common (non-achromatic) Microscopes; in which, whatever be the size of the lens itself, the greater portion of its surface is rendered inoperative by a *stop*, which is a plate with a circular aperture interposed between the lens and the rest of the instrument. If this aperture be gradually enlarged, it will be seen that, although the image becomes more and more illuminated, it is at the same time becoming more and more indistinct; and that, in order to gain *defining power*, the aperture must be reduced again. Now, this reduction is attended with two great inconveniences: in the first place, the loss of intensity of light, the degree of which will depend upon the quantity transmitted by the lens, and will vary therefore with its aperture; and, secondly, the diminution of the *Angle of Aperture*, that is, of the angle  $a b c$  (Fig. 10) made by the most diverging of the rays of the pencil issuing from any point of an object, that can enter the lens and take part in the formation of an image of it; on the extent of which angle (as will be shown hereafter) depend some of the most important qualities of a Microscope.

11. The Spherical Aberration may be approximately corrected, however, by making use of *combinations* of lenses, so disposed that their opposite aberrations shall correct each other, whilst magnifying power is still gained. For it is easily seen that, as the aberration of a concave lens is just the opposite of that of a convex lens, the aberration of a convex lens placed in its most favorable position may be corrected by that of a concave lens of much less power in its most unfavorable position; so that, although the power of the convex lens is weakened, all the rays which pass through this combination will be brought to one focus. It is thus that the Optician aims to correct the Spherical Aberration, in the construction of those combinations of lenses which are now employed as Object-glasses in all Compound Microscopes that are of any real value as instruments of observation. But this correction is not always perfectly made: and the want of it becomes evident in the *fog* by which the distinctness of the image, and especially the sharpness of its outlines, is impaired; and in the *eidola*, or false images, on each side of the best focal point, which impair the perfection of the principal image, and can be themselves brought into view when proper means are used for their detection.<sup>1</sup> The skill of the best constructors of Microscopic objectives has been of late years successfully exerted in the removal of the 'residual errors' to which these *eidola* were due; so that objectives of the largest angular aperture are now made truly *aplanatic*, the corrections for Spherical Aberration being applied with a perfection which was formerly supposed to be attainable only in the case of Objectives of small or moderate aperture. Still, the difficulty (and the consequent cost) of producing such objectives, constitutes one out of many reasons for the preference of objectives of moderate aperture, in which the correction for Spherical Aberration can be easily made complete, for all the ordinary purposes of scientific investigation (§ 17).

12. But spherical aberration is not the only difficulty with which the Optician has to contend in the construction of Microscopes; for one

---

<sup>1</sup> See Dr. Royston Pigott's description of his "Searcher for Aplanatic Images," and its uses, in the "Philos. Transact." for 1870, p. 59.

equally serious arises from the *unequal refrangibility* of the several Colored rays which together make up White or colorless light,<sup>1</sup> so that they are not all brought to the same focus, even by a lens free from spherical aberration. It is this difference in their refrangibility, which causes their complete separation or 'dispersion' by the Prism into a *spectrum*; and it manifests itself, though in a less degree, in the image formed by a convex lens. For if parallel rays of white light fall upon a convex surface, the *most* refrangible of its component rays, namely, the *violet*, will be brought to a focus at a point somewhat nearer to the lens than the principal focus, which is the mean of the whole; and the converse will be true of the *red* rays, which are the *least* refrangible, and whose focus will therefore be more distant. Thus in Fig. 9, the rays of white light, A B, A'' B'', which fall on the peripheral portion of the lens, are so far decomposed, that the violet rays are brought to a focus a c, and crossing there, diverge again and pass on towards F F, whilst the red rays are not brought to a focus until D, crossing the divergent violet rays at E E. The foci of the intermediate rays of the spectrum (indigo, blue, green, yellow, and orange) are intermediate between these two extremes. The distance C D between the foci of the *violet* and of the *red* rays respectively, is termed *Chromatic Aberration*. If the image be received upon a screen placed at c—

the focus of the violet rays—violet will predominate in its own color, and it will be surrounded by a prismatic fringe in which blue, green, yellow, orange, and red may be successively distinguished. If, on the other hand, the screen be placed at D—the focus of the red rays—the image will have a predominantly red tint, and will be surrounded by a series of colored fringes in inverted order, formed by the other rays of the spectrum which have met and crossed.<sup>2</sup> The line E E, which joins the points of intersection between the red and the violet rays, marks the 'mean focus,' that is, the situation in which the colored fringes will be narrowest, the 'dispersion' of the colored rays being the least. As the axial ray A' B' undergoes no refraction, neither does it sustain any dispersion; and the nearer the rays are to the axial ray, the less dispersion do they suffer. Again, the more oblique the direction of the rays, whether they pass through the central or the peripheral portion of the lens, the greater will be the refraction they undergo, and the greater also will be their dispersion; and thus it happens that when, by using only the central part of a lens (§ 13), the chromatic aberration is reduced to its minimum, the central part of a picture may be tolerably free from false colors, whilst

FIG. 9.

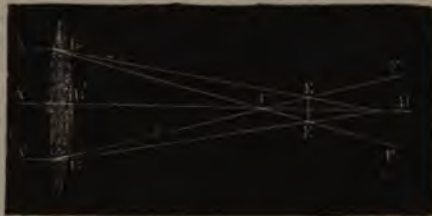

Diagram illustrating Chromatic Aberration.

<sup>1</sup> It has been deemed better to adhere to the ordinary phraseology, when speaking of this fact, as more generally intelligible than the language in which it might be more scientifically described, and at the same time leading to no practical error.

<sup>2</sup> This experiment is best tried with a lens of long focus, of which the central part is covered with an opaque stop, so that the light passes only through a peripheral ring; since, if its whole aperture be in use, the regular formation of the fringes is interfered with by the *spherical* aberration, which gives a different focus to the rays passing through each annular zone.

its marginal portion shall exhibit broad fringes, as is well seen in the pictures exhibited by non-achromatic Oxhydrogen-Microscopes.

13. Although the Chromatic aberration of a lens, like the Spherical, may be diminished by the contraction of its aperture, so that only its central portion is employed, the error cannot be got rid of entirely by any such reduction, which, for the reasons already mentioned, is in itself extremely undesirable. Hence it is of the first importance in the construction of a really efficient Microscope, that the chromatic aberration of its Object-glasses (in which the principal dispersion is liable to occur) should be entirely *corrected*, so that a large aperture may be given to these lenses without the production of any false colors. No such correction can be accomplished, even theoretically, in a single lens; but it may be effected by the combination of two or more, advantage being taken of the different relations which the *refractive* and the *dispersive* powers bear to each other in different substances. For if we can unite with a *convex* lens, whose dispersive power is *low* as compared to its refractive power, a *concave* of lower curvature, whose dispersive power is relatively *high*, it is obvious that the dispersion of the rays occasioned by the convex lens may be effectually *neutralized* by the opposite dispersion of the concave (§ 6); whilst the refracting power of the convex is only *lowered* by the opposite refraction of the concave, in virtue of the longer focus of the latter.—No difficulty stands in the way of carrying this theoretical correction into practice. For the ‘dispersive’ power of *flint-glass* bears so much larger a ratio to its refractive power than does that of *crown-glass*, that a convex lens of the former whose focal length is  $7\frac{1}{2}$  inches, will produce the same degree of color as a convex lens of crown-glass whose focal length is  $4\frac{1}{2}$  inches. Hence a concave lens of the former material and curvature will fully correct the dispersion of a convex lens of the latter; whilst it diminishes its refractive power to such an extent only as to make its focus 10 inches.—A perfect correction for Chromatic Aberration might thus be obtained, if it were not that although the extreme rays—violet and red—are thus brought to the same focus, the dispersion of the rest is not equally compensated; so that what is termed a *secondary spectrum* is produced; the images of objects, especially towards the margin of the field, being bordered on one side with a purple fringe, and on the other with a green. In the best constructed combinations, however, whether for the Telescope or the Microscope, the chromatic error is scarcely perceptible; the aberrations of the objective being so arranged as to be almost entirely compensated by the opposite aberrations of the eye-piece (§ 27).

14. It was in the Telescope that the principle of correction for Chromatic dispersion, which had been theoretically devised by Euler and other mathematicians, was first carried into practical application; an Achromatic object-glass having been constructed in 1733 by Hall, and a more perfect combination having been worked out in 1757 by Dollond, whose system, known as the ‘telescopic triplet,’ remains in use to the present time. This triplet consists of a double-concave lens of flint-glass, interposed between two double-convex lenses of crown; such curves being given to their respective surfaces, as serve almost entirely to extinguish not only the Chromatic, but the Spherical aberration, in the case of rays proceeding from *distant* objects, which fall on the surface of the object-glass in a direction that is virtually *parallel*. These rays form an image in the ‘principal focus’ of the object-glass, the size of which varies with its distance from the lens; magnifying power being thus gained by



*lengthening* the focus of the objective.—In the Microscope, on the other hand, the conditions are altogether different. For the object-glass receives rays which *diverge* very widely from a *near* object, and the size of the image formed by their convergence depends upon the proportionate distances of the object and the image from the lens (§ 8); magnifying power being thus gained by *shortening* the focus of the object-glass. And the chromatic and spherical aberrations resulting from the incidence of diverging rays can only be fairly corrected by a *single-triplet* combination, when its focus is long (giving a low magnifying power), and the divergence of those rays moderate, so that the angle of the aperture is small.

15. It has only been in comparatively recent times that the construction of Achromatic object-glasses for Microscopes has been found practicable; their extremely minute size having been thought to forbid the attainment of that accuracy which is necessary in the adjustment of the several curvatures, in order that the errors of each of the separate lenses which enters into the combination, may be effectually balanced by the opposite errors of the rest. The first successful attempt was made in

FIG. 10.



Section of an Achromatic Object-glass, composed of three pairs of lenses, 1, 2, 3, each formed of a double-convex of crown-glass and a plano-concave of flint; *a b c*, its Angle of Aperture.

FIG. 11.

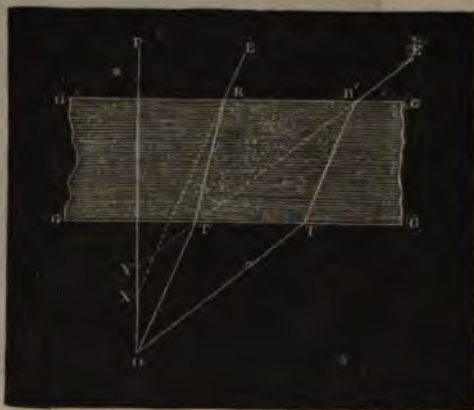

this direction in the year 1823 by MM. Selligues and Chevalier, of Paris; the plan which they adopted being the combination of two or more *pairs* of lenses, each pair consisting of a double-convex of crown-glass and a plano-concave of flint.—In the following year, Mr. Tulley, of London, without any knowledge of what had been accomplished in Paris, applied himself (at the suggestion of Dr. Goring) to the construction of Achromatic object-glasses for the Microscope; and succeeded in producing a single combination of three lenses, on the telescopic plan, the corrections of which were extremely complete. This combination, however, was not of high power, nor of large angular aperture; and it was found that these advantages could not be gained without the addition of a second combination.—Prof. Amici at Modena, also, who had attempted the construction of microscopic object-glasses as early as 1812, but, despairing of success, had turned his attention to the application of the *reflect-*

## PLATE I.

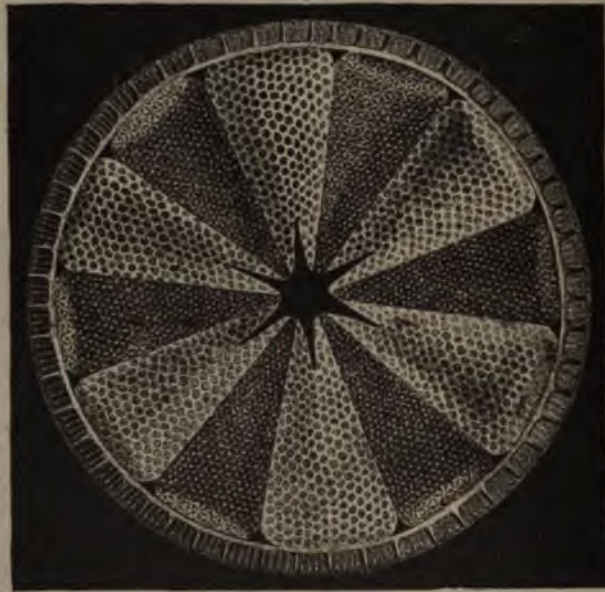

## VARIOUS FORMS OF DIATOMACEE.

- Fig. 1. *Actinocyclus Ralfsii*.  
 2. *Asterolampra concinna*.  
 3. *Heliopelta* (as seen with black-ground illumination).  
 4. *Asterumphalus Brookeii*.  
 5. *Aulacodiscus Oregonus*.



## Plate II

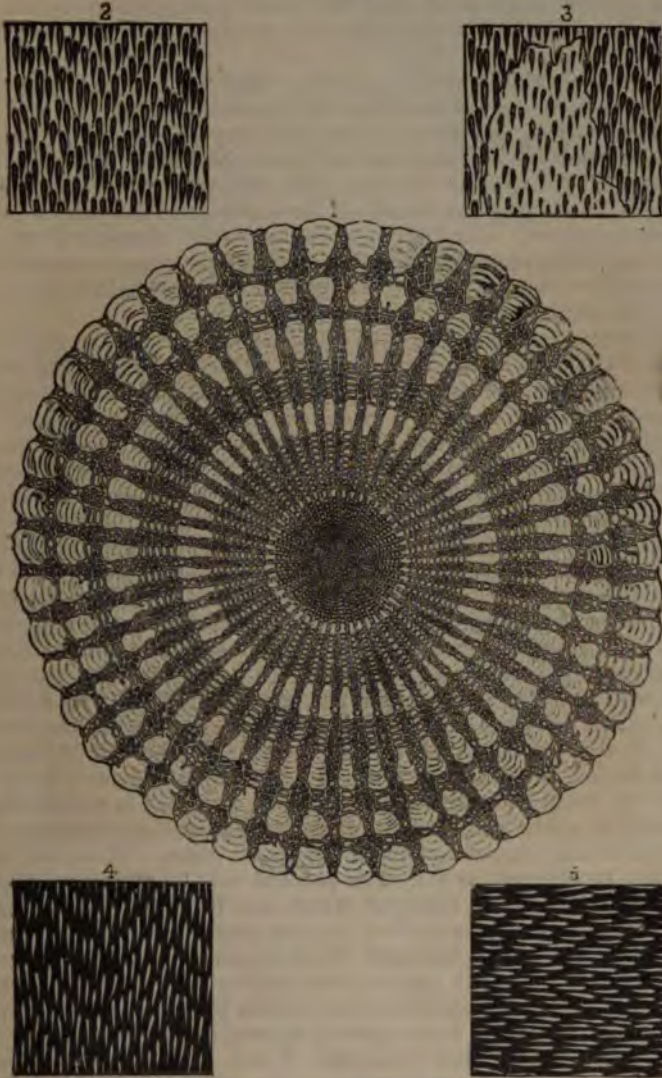

ECHINUS-SPINE (Original), AND PODURA SCALE (after R. Beck).

- Fig. 1. Transverse section of Spine of *Echinometra heteropora*.  
 2. Markings on Scale of *Podura*, as seen by transmitted light under a well-corrected 1-8th inch Objective.  
 3. Partial obliteration of the markings by the insinuation of moisture between the Scale and the covering-glass.  
 4. Appearance of the markings, when the Scale is illuminated from above the oblique light falling at right angles to them.  
 5. The same, when the light falls on the Scale in the direction of the markings.

Mr. Smith resumed his original labors on hearing of the success of the Government and by working on their principles, he effected a happy combination which surpassed all that had been previously executed. And the same happy result was obtained in London by Andrew

Smith, so early that the next important improvements were the result of the theoretical investigations of Mr. Smith, which led to the discovery of certain properties in combinations that had not been previously detected. Under the name of James Smith, soon followed by other Opticians, were made combinations far superior to any which had been previously made, both in extent of aperture, darkness of field, and brilliancy of illumination; and continued progress has been since made, not only by the like combination of theoretical acumen with

the management of the Angle of Aperture, and the greater combinations of lenses, first obtained by the adoption of Mr. Lister's system, but also by the discovery of certain circumstances, which had previously passed unobserved, and the important discovery was made by Mr. A. Ross that a great difference exists in the precision of the image, according to the manner in which the object-glass is viewed, *with* or *without* a covering of talc or thin glass; and that the image is probably defective under the other. The mode in which this difference was explained by Mr. Ross is as follows:—Let  $o$  (Fig. 11) be any point of an object;  $o P$  the axial ray of the pencil that diverges from it;  $o P$  and  $o Q$  two diverging rays, the one near to, the other remote from, the axial ray. Now if  $o P Q R$  represent the section of a piece of thin glass intervening between the object and the object-glass, the rays  $o P$  and  $o Q$  will be refracted in their passage through it, in the directions  $P R$  and  $Q R$ , and on emerging from it again, they will pass on towards  $E$  and  $F$ . Now if the course of these emergent rays be traced backwards, as by the dotted lines, the ray  $E R$  will seem to have issued from  $x$ , and the ray  $F R$  from  $y$ ; and the difference  $x y$ , which is called 'negative aberration,' is quite sufficient to disturb the previous balance of the aberrations of the composite lens of the object-glass. The requisite correction may be effected, as Mr. Ross pointed out, by giving to the *front* pair (Fig. 10, 1) of the three of which the Objective is composed, an excess of 'positive aberration' (*i. e.*, by under-correcting it, and by giving to the other two pairs (2, 3) an excess of 'negative aberration' (*i. e.*, by over-correcting them), and by making the distance between the *front* pair and the latter susceptible of alteration by means of a screw collar (Fig. 10, 2). For when the front pair is approximated most nearly to the other two, and its distance from the object is increased, its positive aberration is more strongly exerted upon the other pairs than it is when the distance between the lenses is increased, and the distance between the *front* pair and the object is diminished. Consequently, if the lenses be so adjusted that their correction is perfect for an uncovered object, the approximation of the front lens to the others will give to the image a certain excess of positive aberration, which will neutralize

See *Account* in the "Philosophical Transactions" for 1829.  
*Transactions of the Society of Arts*, vol. li.

the negative aberration occasioned by covering the object with a thin plate of glass.—This correction will obviously be more important to the perfect performance of the combination, the larger is its angle of aperture; since the wider the divergence of the oblique rays from the axial ray, the greater will be the refraction which they will sustain in passing through a plate of glass, and the greater therefore will be the negative aberration produced, which, if uncorrected, will seriously impair the distinctness of the image. It is consequently not required for *low* powers whose angle of aperture is comparatively small, nor for *medium* powers, so long as their angle of aperture does not exceed  $50^\circ$ , and even objectives of  $\frac{1}{4}$  of an inch focus, whose angle of aperture does not exceed  $75^\circ$ , may be made to perform very well without adjustment, if their corrections be originally made perfect for the average thickness of glass used to cover objects of the finer kind. And objectives of much higher power and larger angle of aperture (especially suited for Students' Microscopes), are now constructed so as to work admirably without adjustment, being corrected for a standard thickness—such as 0.008 or 0.006 inch—of the glass covers supplied by their makers. Such non-adjusting objectives, when less than  $\frac{1}{4}$  inch focus, are best constructed on the 'immersion' system (§ 19).

18. For many years the best Microscopic objectives of moderate and high magnifying power were made by combining three superposed pairs of increasing focus and diameter (as in Fig. 10), each consisting of a double-convex lens of crown-glass partly achromatized by its own concave of flint; the two apposed surfaces of each pair being of the same curvature, and cemented together by Canada balsam. Various modifications of this arrangement, however, have been introduced at various times and by various constructors; some proceeding in the direction of simplification, whilst others have aimed at the greatest attainable perfection, irrespective of complexity and constructive difficulty. It is obvious that there are great practical advantages on the side of any *reduction* in the number of component lenses, that is compatible with the good performance of the combination: liability to error, as well in the curved surfaces, as in the centering and setting of each, being thereby diminished, while there is a like diminution in the loss of light which occurs whenever the rays pass out of one medium into another (§ 1). But, on the other hand, it seems certain that the highest theoretical perfection can be attained by an *increase* in the number of component lenses; so that, if the errors in workmanship are kept down to the lowest possible point, the performance of such complex combinations may be made superior to that of simpler ones.—The first important change in the direction of simplification consisted in the replacement of the *front* combination by a *single* plano-convex of crown. This substitution, which seems to have been first devised by Amici, has been very generally adopted; a greater working distance from the object (which is very important in the case of the highest powers) being attainable in this construction, than when the front is either a doublet or a triplet combination. But most makers who have used this method have added a lens to the *back* combination, making it a 'telescopic triplet,' still using a doublet in the *middle*; and admirable objectives on this construction (each consisting of two flint concave and four convex lenses of crown, with *twelve* surfaces in all) have been made by the best Opticians—English and American, French and German.—A further simplification has been recently carried into effect by Mr. Wenham; who



has shown<sup>1</sup> that the whole color-correction may be effected in the *mid-~~de~~ zone* by a double-concave of dense flint between two convex lenses of crown, the back lens as well as the front being a single plano-convex of crown. Thus one double concave lens of flint is made to correct the chromatic aberrations of four convex surfaces of crown, the total number of surfaces being reduced to ten. There is a further advantage in this plan of construction, that no change of the front lens is needed to enable the combination to be used as an 'immersion' objective (§ 19), the requisite adjustment being effected by the screw-collar used for cover-correction.—There can be no doubt that objectives of moderate angular aperture may be made on Mr. Westham's system, so as to combine great excellence with comparative cheapness; but it does not seem equally suitable for first-class objectives, requiring for their greatest efficiency the widest attainable angular aperture. These have usually been made to consist of a front triplet, a middle doublet, and a back triplet, thus having eight lenses in all, with sixteen surfaces. But the first-class constructors in the United States (notably Messrs. Tolles, Spencer, and Wales) have added to these a single front plano-convex of crown, by means of which a longer working distance has been obtained; whilst the extraordinary excellence of their workmanship (only attainable, however, at a very high cost) has given to these very complex combinations a perfection of performance, which, to say the least, is unsurpassed by that of any objectives constructed for use in the ordinary manner, which is now distinguished as *dry*.

15. It was long since pointed out by Amici that the introduction of a drop of water between the front surface of the objective, and either the object itself or its covering-glass, would diminish the loss of light resulting from the passage of the rays from the object or its covering-glass into air, and then from air into the object-glass. But it is obvious that when the rays enter the object-glass from water, instead of from air, both its refractive and its diaphragmatic action will be greatly changed, so as to need an important constructive modification to suit the new condition. This modification seems never to have been successfully effected by Amici himself; and his idea remained unfruitful until it was taken up by Hartnack and Næchet, who showed that the application of what is now known as the *Immersion-system* to objectives of high power and large angular aperture is attended with many advantages not otherwise attainable. For, as already pointed out (§ 1), the loss of light increases with the obliquity of the incident rays; so that when objectives of very wide angle of aperture are used 'dry,' the advantages of its increase are in great degree nullified by the reflection of a large proportion of the rays falling very obliquely upon the peripheral portion of the front lens. When, on the other hand, rays of the same obliquity enter the peripheral portion of the lens from water, the loss by reflection is greatly reduced, and the benefit derivable from the large aperture is proportionally augmented. Again, the 'immersion system' allows of a greater working distance between the objective and the object, than is otherwise attainable with the same extent of angular aperture; and this is a great advantage, not merely in regard to convenience in manipulation, but also in giving a greater range of 'penetration' or 'focal depth.' Further, the observer is rendered less dependent upon the exactness in the correction for the thickness of the covering-glass, which is needed where objectives of large

<sup>1</sup> "Proceedings of Royal Society," Vol. xxi., p. 111.

angle are used 'dry;' for as the amount of 'negative aberration' (§ 17) is far smaller when the rays which emerge from the covering-glass pass into water than when they pass into air, variations in its thickness produce a much less disturbing effect. And thus it is found practically that 'immersion' objectives can be constructed with magnifying powers sufficiently high, and angular apertures sufficiently large, for all the ordinary purposes of scientific investigation, without any necessity for cover-adjustment; being originally adapted to give the best results with a covering-glass of suitable thinness, and small departures from this in either direction occasioning very little deterioration in their performance. For 'water-immersion' objectives of the very largest aperture, however, to be used upon the most difficult objects, exact cover-correction is still necessary.—Whilst 'immersion' objectives constructed on the original plan can only be employed 'wet' (that is with the interposition of water), Messrs. Powell and Leland—followed by other makers—have so arranged their combinations, that by a change in the front lens they may be used 'dry,' as in the ordinary manner. And in Mr. Wenham's system not even this change is required, the change from 'wet' to 'dry,' and *vice versa*, being accomplished by an alteration in the distance of the front lens from the middle triplet, made by the screw-collar, as in ordinary cover-correction.

20. The 'immersion system' has recently undergone a still further development, by the practical application of a method originally suggested by Mr. Wenham<sup>1</sup> (but never carried by him into operation), and independently suggested by Mr. Stephenson<sup>2</sup> to Prof. Abbe of Jena, under whose scientific direction it has been worked out by the very able German optician, Zeiss, with complete success. This method consists in the replacement of the water previously interposed between the covering-glass and the front surface of the objective, by a liquid having the same refractive and dispersive power as crown-glass; so that the rays issuing at any angle from the upper plane surface of the covering-glass, shall enter the plane front of the objective without any change either by refraction or dispersion, and without any sensible loss by reflection—even the most oblique rays proceeding in their undeflected course, until they meet the convex back surface of the front lens. It is obvious that all the advantages derivable from the system of *water* immersion are obtainable with still greater completeness by this system of *homogeneous* immersion, provided that a fluid can be found which meets its requirements. After a long course of experiments, Prof. Abbe found that oil of cedar-wood so nearly corresponds with glass, alike in refractive and in dispersive power, that it serves the purpose extremely well, except when it is desired to take special advantage of the most divergent or marginal rays, oil of fennel being then preferable. Objectives of  $\frac{1}{4}$ th,  $\frac{1}{4}$ th, and  $\frac{1}{8}$ th inch focal length have been constructed on this plan by Zeiss; and it appears certain that by its means a larger angle of aperture can be effectively obtained, than on any other construction. Whether any tests can be resolved by its use, on which other objectives fail, is a point not yet satisfactorily determined. But there can be no doubt that the system of 'homogeneous immersion' will greatly facilitate the use of objectives possessing the largest angular aperture, and capable of affording the highest magnifying power, for the ordinary purpose of scientific research. It is

<sup>1</sup> "Monthly Microscopical Journal," Vol. iii. (1870), p. 303.

<sup>2</sup> "Journ. of Royal Microsc. Society," Vol. i. (1878), p. 51.

precisely in the case of such objectives that the 'cover-correction' needs to be most exact. And although the practised microscopist has no difficulty in making this, when the object at which he is looking (such as a Diatom, a Podura-scale, or a band of Nobert's ruled lines) is *known* to him, yet the case is entirely different when the object is altogether *unknown*. For in examining such an object, he may be able only to satisfy himself after repeated trials, involving much expenditure of time and patience, as to the cover-correction which gives the truest representation of the object; whilst, in using a 'homogeneous' or 'oil-immersion' objective, he is able to feel an absolute certainty that, without any adjustment at all, the view which he gains of an unknown object is in every respect at least equal to that which he can obtain from the best 'dry' or 'water-immersion' objective, most exactly adjusted for thickness of cover.—This system has been taken up also by Messrs. Powell and Lealand, who have constructed admirable 'oil-immersion' objectives ranging to 1-25th inch focus, which, by a change of the front lens, may also be used 'dry.'

21. We are now prepared to enter upon the application of the Optical principles which have been explained and illustrated in the foregoing pages, to the construction of Microscopes. These are distinguished as *Simple* and *Compound*; each kind having its peculiar advantages to the Student of Nature. Their essential difference consists in this:—that in the former, the rays of light which enter the eye of the observer proceed directly from the *object* itself, after having been subjected only to a change in their course; whilst in the latter, an enlarged *image* of the object is formed by one lens, which image is magnified to the observer by another, as if he were viewing the object itself.—The *Simple* Microscope may consist of a single lens; but (as will be presently shown) it may be formed of *two*, or even *three*: these, however, being so disposed as to produce an action upon the rays of light corresponding to that of a single lens. In the *Compound* Microscope, on the other hand, not less than two lenses *must* be employed: one, to form the enlarged image of the object, immediately over which it is placed, and hence called the *object-glass*; whilst the other again magnifies that image, and, being interposed between it and the eye of the observer, is called the *eye-glass*. A perfect Object-glass, as we have seen, must consist of a combination of lenses; and the eye-glass is best combined with another lens interposed between itself and the object-glass, the two together forming what is termed an *eye-piece* (§ 27).—These two kinds of instrument need to be separately considered in detail.

## 2. *Simple Microscope.*

22. In order to gain a clear notion of the mode in which a Single Lens serves to 'magnify' minute objects, it is necessary to revert to the phenomena of ordinary Vision. An Eye free from any defect has a considerable power of adjusting itself in such a manner as to gain a distinct view of objects placed at extremely varying distances; but the image formed upon the retina will of course vary in size with the distance of the object; and the amount of detail perceptible in it will follow the same proportion. To ordinary eyes, however, there is a limit within which no distinct image can be formed, on account of the too great divergence of the rays of the different pencils which then enter the eye; since the eye is usually adapted to receive, and to bring to a focus, rays which are parallel or but slightly divergent. This limit is vari-



ously stated at from 5 to 10 inches; but though there are doubtless many persons whose vision is good at the shorter range, yet the longer is probably the real limit for persons of ordinary vision: who, though they may see an object much nearer the eye, discern little if any more of its details, what is gained in size being lost in distinctness. Now the utility of a convex lens interposed between a near object and the eye, consists in its reducing the divergence of the rays forming the several pencils which issue from it; so that they enter the eye in a state of moderate divergence, as if they had issued from an object beyond the nearest limit of distinct vision, a well-defined picture being thus formed upon the retina. Not only, however, is the course of the several rays in each pencil altered as regards the rest, but the course of the pencils themselves is changed, so that they enter the eye under an angle corresponding with that under which they would have arrived from a larger object situated at a greater distance; and thus the picture formed upon the retina by any object (*a b*, Fig. 12), corresponds in all respects with one which would have been made by the same object increased in its dimensions to *A B*, and viewed at the smallest ordinary distance of distinct vision. A 'short-sighted' person, however, who can only see objects distinctly at a distance of two or three inches, has the same power in his eye alone by reason of its great convexity, as that which the person of ordinary vision gains by the assistance of a convex lens which shall enable him to see at the same distance with equal distinctness. It is evident, therefore, that the magnifying power of a single lens, depending as it does upon the proportion between the distance at which it renders the object visible, and the nearest distance of unaided distinct vision, must be different to different eyes. It is usually estimated, however, by finding how many times the focal length of the lens is contained in ten inches; since, in order to render the rays from the object nearly parallel, it must be placed nearly in the focus of the lens (Fig. 3); and the picture is referred by the mind to an object at the ordinary distance. Thus, if the focal length of a lens be one inch, its magnifying power for each dimension will be 10 times, and consequently 100 superficial; while if its focal distance be only one-tenth of an inch, its magnifying power will be 100 linear, or 10,000 superficial.



Diagram illustrating the action of the *Simple Microscope*; *a b* object; *A B* its magnified image.

23. But the shorter the focus of the magnifying lens, the smaller must be the diameter of the sphere of which it forms part; and, unless its aperture be proportionately reduced, the distinctness of the image will be destroyed by the spherical and chromatic aberrations (§§ 9, 12) necessarily resulting from its high curvature. Yet notwithstanding the loss of light and other drawbacks attendant on the use of Single Lenses of high power, they proved of great value to the older Microscopists (among whom *Leeuwenhoek* should be specially named), on account of their freedom from the errors to which the Compound Microscope of the old construction was necessarily subject; and the amount of excellent

WOLLASTON'S DOUBLET. It surprises every one who studies the history of Microscopic inquiry.—An important improvement on the single lens was introduced by Dr. Wollaston, who devised the *doublet*, still known by the name; which consists of two plano-convex lenses, whose focal lengths are in the proportion of one to three, or nearly so, having their convex sides directed towards the eye, and the lens of shortest focal length nearest the object. In Dr. W.'s original combination, no perforated diaphragm (or 'stop') was interposed; and the distance between the lenses was left to be determined by experiment in each case. A great improvement was subsequently made, however, by the introduction of a 'stop' between the lenses and by the division of the power of the smaller lens between two (especially when a very short focus is required), so as to form a *triplet*, as first suggested by Mr. Holland.<sup>1</sup> When combinations of this kind are well constructed, both the spherical and the chromatic aberrations are so much reduced, that the angle of aperture may be considerably enlarged without much sacrifice of distinctness; and hence for all have very low powers, such 'doublets' and 'triplets' are far superior to single lenses. These combinations took the place of single lenses, among Microscopists (in this country at least) who were prosecuting minute investigations in Anatomy and Physiology prior to the vast improvements effected in the Compound Microscope by the achromatization of its object-glasses (§ 15); and, in particular, the admirable researches of Dr. Sharpey,<sup>2</sup> on *ciliary action* in Animals (1830–35), and Mr. Henry Slack's beautiful dissections of the elementary tissues of Plants, and also his excellent observations on Vegetable *cyclosis* (1831),<sup>3</sup> were made by their means.—The performance of even the best of these forms of Simple microscope, however, is so far inferior to that of a good Compound microscope, as now constructed, that no one who has the command of the latter form of instrument would ever use the *higher* powers of the former. And as it is for the prosecution of observations, and for the carrying on of dissections, which only require *low* powers, that the Simple microscope is chiefly needed, the Wollaston doublet has now almost gone out of use.

24. Another form of Simple magnifier, possessing certain advantages over the ordinary double-convex lens, is that commonly known by the name of the 'Coddington' lens.<sup>4</sup> The first idea of it was given by Dr. Wollaston, who proposed to apply two plano-convex or hemispherical lenses by their plane sides, with a 'stop' interposed, the central aperture of which should be equal to one-fifth of the focal length. The great advantage of such a lens is, that the oblique pencils pass, like the central ones, at right angles to the surface, so that they are but little subject to aberration. The idea was further improved upon by Sir D. Brewster, who pointed out that the same end would be much better answered by taking a sphere of glass, and grinding a deep groove in its equatorial part, which should be then filled with opaque matter, so as to limit the central aperture. Such a lens gives a large field of view, admits a con-

<sup>1</sup> "Transactions of the Society of Arts," Vol. xlix.

<sup>2</sup> See his article *Cilia* in the "Cyclopædia of Anatomy and Physiology," and the references under that head in the Index to the present work.

<sup>3</sup> See his Memoir, with two beautiful Plates, in the "Transactions of the Society of Arts," Vol. xlix., pp. 6, 7.

<sup>4</sup> This name, however, is most inappropriate; since Mr. Coddington neither was, nor ever claimed to be, the inventor of the mode of construction by which this lens is distinguished.



siderable amount of light, and is equally good in all directions; but its power of definition is by no means equal to that of an achromatic lens, or even of a doublet. This form is chiefly useful, therefore, as a Hand-magnifier, in which neither high power nor perfect definition is required; its peculiar qualities rendering it superior to an ordinary lens, for the class of objects for which a hand-magnifier of medium power is required. Many of the magnifiers sold as 'Coddington' lenses, however, are not really portions of spheres, but are manufactured out of ordinary double-convex lenses, and are therefore destitute of the special advantages of the real 'Coddington.'—The 'Stanhope' lens somewhat resembles the preceding in appearance, but differs from it essentially in properties. It is nothing more than a double-convex lens, having two surfaces of unequal curvatures, separated from each other by a considerable thickness of glass; the distances of the two surfaces from each other being so adjusted, that when the most convex is turned towards the eye, minute objects placed *on* the other surface shall be in the focus of the lens. This is an easy mode of applying a rather high magnifying power to scales of butterflies' wings, and the other similar flat and minute objects, which will readily adhere to the surface of glass; and it also serves to detect the presence of the larger animalcules or of crystals in minute drops of fluid, to exhibit the 'eels' in paste or vinegar, etc., etc.—A modified form of the 'Stanhope' lens, in which the surface remote from the eye is plane instead of convex, has been brought out in France under the name of 'Stanhoscope,' and has been especially applied to the enlargement of minute pictures photographed on its plane surface in the focus of its convex surface. A good 'Stanhoscope,' magnifying from 100 to 150 diameters, is a very convenient form of hand-magnifier for the recognition of Diatoms, Infusoria, etc.; all that is required being to place a minute drop of the liquid to be examined on the plane surface of the lens, and then to hold it up to the light.<sup>1</sup>

25. For the ordinary purposes of Microscopic dissection, *single lenses* of from 3 to 1 inch focus answer very well. But when higher powers are required, and when the use of even the lower powers is continued for any length of time, great advantage is derived from the employment of Achromatic combinations now made expressly for this purpose by several Opticians. The writer has worked most satisfactorily for several years with the 'platyscopic lens,' magnifying about 15 diameters, made by Mr. Browning, who makes similar combinations of 20 and 30 diameters. And he can speak equally favorably of the 'Steinheil doublets' (constructed by the eminent Munich optician of that name, and introduced into this country by Messrs. Murray and Heath), of which there are six, ranging from  $2\frac{3}{8}$  inches to  $\frac{3}{8}$  inch focus. The Browning and the Steinheil combinations give much more light than single lenses, with much better definition, a very flat field, longer working distance (which is very important in minute dissection), and, as a consequence, greater 'focal depth' or 'penetration'—*i. e.* a clearer view of those parts of the object which lie above or below the exact local plane. And only those who, like the writer, have carried on a piece of minute and difficult dissection through several consecutive hours, can appreciate the advantage in comfort and in *diminished fatigue of eye*, which is gained by the substitution

<sup>1</sup> See "Quart. Journ. of Microsc. Science," Vol. vi., N.S. (1866), p. 263—Of the Stanhosopes sold by Toy-dealers at a very low price, only a part are really serviceable; care is requisite, therefore, in the selection.



of the former: Achromatic combinations for a single lens of equivalent focal length, where the use of the former reveals no detail that is not disclosed by the latter.

### 3. Compound Microscope.

26. The Compound Microscope, in its most simple form, consists of only two lenses, the *object-glass* and the *eye-glass*. The former,  $CD$  (Fig. 13), receives the light-rays direct from the object,  $AB$ , brought into near proximity to it, and forms an enlarged but *inverted* and *reversed* image,  $A'B'$ , at a greater distance on the other side (§ 8); whilst the latter,  $LM$ , receives the rays which are diverging from this image, as if they proceeded from an object actually occupying its position and enlarged to its dimensions, and brings these to the eye at  $E$ , so altering their course as to make that image appear far larger to the eye, precisely as in the case of the Simple microscope (§ 22).—It is obvious that, in the use of the very same lenses, a considerable variety of magnifying power may be obtained, by merely altering their position in regard to each other and to the object: for if the eye-glass be carried farther from the object-glass, whilst the object is approximated nearer to the latter, the image  $A'B'$  will be formed at a greater distance from it, and its dimensions will consequently be augmented; whilst, on the other hand, if the eye-glass be brought nearer to the object-glass, and the object removed farther from it, the distance of the image will be a much smaller multiple of the distance of the object, and its dimensions proportionately diminished. We shall hereafter see that this mode of varying the magnifying power of Compound Microscopes may be turned to good account in more than one mode (§§ 83, 84); but there are limits to the use which can be advantageously made of it.—The amplification may also be varied by altering the magnifying power of the Eye-glass; but here, too, there are limits to the increase; since defects of the object-glass which are not perceptible when its image is but moderately enlarged, are brought into injurious prominence when the imperfect image is amplified to a much greater extent. In practice, it is generally found much better to vary the power by employing object-glasses of different foci: an object-glass of *long* focus forming an image which is not at many times the distance of the object from the other side of the lens, and which, therefore, is not of many times its dimension; whilst an object-glass of *short* focus requires that the object should be so nearly approximated to it, that the distance of the image is a much higher multiple of the object, and its dimensions are proportionably larger.—In whatever mode increased amplification may be obtained, two things must always result from the change: the proportion of the surface of the object of which an image can be formed must be diminished; and the quantity of light spread over that image must be proportionably lessened.

27. In addition to the two lenses of which the Compound Microscope essentially consists, it is found advantageous to introduce another ( $FF$ , Fig. 14), between the object-glass and the image formed by it; the purpose of this lens being to change the course of the rays in such a manner, that the image may be formed of dimensions not too great for the whole of it to come within the range of the Eye-glass. As it thus allows more of the object to be seen at once, it has been called the *field-glass*; but it is now usually considered as belonging to the ocular end of the instrument—the *eye-glass* and the *field-glass* being termed the *Eye-piece*. Va-

rious forms of this Eye-piece have been proposed by different Opticians; and one or another will be preferred, according to the purpose for which it may be required. That which it is most advantageous to employ with Achromatic object-glasses, to the performance of which it is desired to give the greatest possible effect, is termed the *Huyghenian*; having been employed by Huyghens for his telescopes, although without the knowledge of all the advantages which its best construction renders it capable of affording. It consists of two plano-convex lenses (E E and F F, Fig. 14), with their plane sides towards the eye; these are placed at a distance equal to half the sum of their focal length; or, to speak with more precision, at half the sum of the focal length of the eye-glass, and of the distance from the field-glass at which an image of the object-glass would be formed by it. A 'stop' or dia-

Diagram of simplest form of Compound Microscope.



Fig. 14.



Diagram of complete Compound Microscope.

phragm, B B, must be placed between the two lenses, in the visual focus of the Eye-glass, which is, of course, the position wherein the image of the object will be formed by the rays brought into convergence by their passage through the field-glass. — Huyghens devised this arrangement merely to diminish the Spherical aberration; but it was subsequently shown by Boscovich that the Chromatic dispersion was also in great part corrected by it. Since the introduction of Achromatic object-glasses for Compound Microscopes, it has been further shown that nearly all error may be avoided by a slight over-correction of these; so that the blue and red rays may be caused to enter the eye in a parallel direction (though not actually co-incident), and thus to produce a colorless image. Thus let N M N (Fig. 15) represent the two extreme rays of three pencils, which, without the field-glass, would form a blue image convex to the eye-glass at B B, and a red one at R R; then, by the intervention of the field-glass, a blue image, concave to the eye-glass, is formed at B' B', and a red one at R' R'. As the focus of the Eye-glass is shorter for blue rays than for red rays by just the differ-



ence in the place of these images, their rays, after refraction by it, enter the eye in a parallel direction, and produce a picture free from false color. If the object-glass had been rendered perfectly achromatic, the blue rays, after passing through the field-glass, would have been brought to a focus at *b*, and the red at *r*; so that an error would be produced, which would have been increased instead of being corrected by the eye-glass. Another

FIG. 15.



Section of *Huyghenian Eye-piece* adapted to over-corrected Achromatic Objectives.

advantage of a well-constructed Huyghenian eye-piece is, that the image produced by the meeting of the rays after passing through the field-glass, is by it rendered concave towards the eye-glass, instead of convex, so that every part of it may be in focus at the same time, and the field of view thereby rendered flat.<sup>1</sup> — Two or more Huyghenian Eye-pieces, of different magnifying powers, known as A, B, C, etc., are usually supplied with a Compound Microscope. The utility of the higher powers will mainly depend upon the excellence of the Objectives; for when an Achromatic combination of small aperture, which is sufficiently well corrected to perform very tolerably with a 'low' or 'shallow' eye-piece, is used with an eye-piece of higher magnifying power (commonly spoken of as a 'deeper' one), the image may lose more in brightness and in definition than is gained by its amplification; whilst the image given by an Objective of large angular aperture and very perfect correction, shall sustain so little loss of light or of definition by 'deep eye-piecing,' that the increase of magnifying power shall be almost clear gain. Hence the modes in which different Objectives of the same power, whose performance with shallow eye-pieces is nearly the same, are respectively affected by deep eye-pieces, afford a good test of their respective merits; since any defect in the corrections is sure to be brought out by the higher amplification of the image, whilst a deficiency of aperture is manifested by the want of light.—The working Microscopist will generally find the A eye-piece most suitable, B being occasionally employed when a greater power is required to separate details, whilst C and other still deeper are useful for the purpose of testing the goodness of Objectives, or for special investigations requiring the highest amplification with Objectives of the finest quality. When great penetration or 'focal depth' is required, low Objectives and deep Eye-pieces will often be found convenient.

28. For viewing large flat objects, such as transverse sections of Wood (Chap. IX.) or of Echinus-spines (Plate II. Fig. 1), under low magnifying powers, the Eye-piece known as *Kellner's* may be employed with advantage. In this construction, the field-glass, which is a double-convex lens, is placed in the focus of the eye-glass, without the interposition of a diaphragm; and the eye-glass is an achromatic combination of a

<sup>1</sup> Those who desire to gain more information upon this subject than they can from the above notice of it, may be referred to Mr. Varley's investigation of the properties of the Huyghenian Eye-piece, in the 51st volume of the "Transactions of the Society of Arts;" and to the article "Microscope," by Mr. Ross, in the "Penny Cyclopædia," reprinted, with additions, in the "English Cyclopædia."

plano-concave of flint with a double-convex of crown, which is slightly under-corrected, so as to neutralize the over-correction given to the Objectives for use with Huyghenian eye-pieces (§ 27). A flat well-illuminated field of as much as fourteen inches in diameter may thus be obtained with very little loss of light; but, on the other hand, there is a certain impairment of defining power, which renders the Kellner eye-piece unsuitable for objects presenting minute structural details; and it is an additional objection, that the smallest speck or smear upon the surface of the field-glass is made so unpleasantly obvious, that the most careful cleansing of that surface is required every time that this Eye-piece is used. Hence it is better fitted for the occasional display of objects of the character already specified than for the ordinary wants of the working Microscopist.

29. A *solid* Eye-piece made on the principle of the 'Stanhope' lens (§ 24) is sometimes used in place of the ordinary Huyghenian, when high magnifying power is required for testing the performance of Objectives. The lower surface, which has the lesser convexity, serves as a 'field-glass;' whilst the image formed by this is magnified by the highly convex upper surface to which the eye is applied; the advantage supposed to be derived from this construction lying in the abolition of the plane surfaces of the two lenses of the ordinary eye-piece. A 'positive' or Ramsden's Eye-piece—in which the field glass, whose convex side is turned upwards, is placed so much nearer the eye-glass that the image formed by the Objective lies below instead of above it,—was formerly used for the purpose of Micrometry; a divided glass being fitted in the exact plane occupied by the image, so that its scale and that image are both magnified together by the lenses interposed between them and the eye. The same end, however, may be so readily attained with the Huyghenian eye-piece (§ 91), that no essential advantage is gained by the use of that of Ramsden, the field of which is distinct only in its centre.

#### 4. *Stereoscopic Binocular Microscope.*

30. The admirable invention of the *Stereoscope* by Professor Wheatstone, has led to a general appreciation of the value of the *conjoint use of both eyes* in conveying to the mind a notion of the *solid forms* of objects, such as the use of either eye singly does not generate with the like certainty or effectiveness. And after several attempts, which were attended with various degrees of success, the principle of the Steroscope has now been applied to the Microscope, with an advantage which those only can truly estimate, who (like the Author) have been for some time accustomed to work with the Stereoscopic Binocular<sup>1</sup> upon objects that are peculiarly adapted to its powers. As the result of this application cannot be rightly understood without some knowledge of one of the fundamental principles of Binocular vision, a brief account of this will be here introduced.—All vision depends in the first instance on the formation of a picture of the object upon the retina of the Eye, just as the Camera Obscura forms a picture upon the ground glass placed in the focus of its lens. But the two images that are formed by the two eyes respectively, of any solid object that is placed at no great distance in front of them, are far from

<sup>1</sup> It has become necessary to distinguish the Binocular Microscope which gives true *Stereoscopic* effects by the combination of two dissimilar pictures, from a Binocular which simply enables us to look with both eyes at images which are essentially identical (§ 81).

being identical; the perspective projection of the object varying with the point of view from which it is seen. Of this the reader may easily conceive himself, by holding up a thin book in such a position that its back shall be at a moderate distance in front of the nose, and by looking at the book, first with one eye and then with the other; for he will find that the two views he thus obtains are essentially different, so that if he were to represent the book as he actually sees it with each eye, the two pictures would by no means correspond. Yet on looking at the object with the two eyes conjointly, there is no confusion between the images, nor does the mind dwell on either of them singly; but from the blending of the two a conception is gained of a solid projecting body, such as could only be otherwise acquired by the sense of Touch. Now if, instead of looking at the solid object itself, we look with the *right* and *left* eyes respectively at pictures of the object, corresponding to those which would be formed by it on the retinae of the two eyes if it were placed at a moderate distance in front of them, and these visual pictures are brought into coincidence, the same conception of a solid projecting form is generated in the mind, as if the object itself were there. The Stereoscope—whether in the forms

FIG. 15.

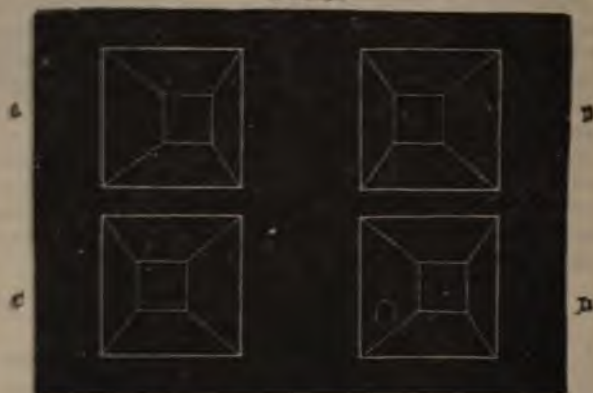

originally devised by Prof. Wheatstone, or in the popular modification long subsequently introduced by Sir D. Brewster—simply serves to bring to the two eyes, either by reflection from mirrors, or by refraction through prisms or lenses, the two dissimilar pictures which would accurately represent the solid object as seen by the two eyes respectively; these being thrown on the two retinae in the precise positions they would have occupied if formed there direct from the solid Object, of which the mental Image (if the pictures have been correctly taken) is the precise counterpart.<sup>1</sup> Thus in Fig. 16 the upper pair of pictures (A, B), when combined in the Stereoscope,<sup>2</sup> suggest the idea of a *projecting* truncated Pyramid,

<sup>1</sup> Although it is a comparatively easy matter to draw in outline two different perspective projections of a Geometrical Solid, such as those which are represented in Fig. 16, it would have been quite impossible to delineate landscapes, buildings, figures, etc., with the same precision; and the Stereoscope would never have obtained the appreciation it now enjoys, but for the ready means supplied by Photography of obtaining simultaneous pictures, perfect in their perspective, and truthful in their lights and shades, from two different points of view so selected as to give an effective Stereoscopic combination.

<sup>2</sup> This combination may be made without the Stereoscope, by looking at these



with the small square in the centre, and the four sides sloping equally away from it; whilst the combination of the lower pair, c, d (which are identical with the upper, but are transferred to opposite sides), no less vividly brings to the mind the visual conception of a *receding* Pyramid, still with the small square in the centre, but the four sides sloping equally towards it.

31. Thus we see that by simply *crossing* the picture in the Stereoscope, so as to bring before each eye the picture taken for the other, a 'conversion of relief' is produced in the resulting solid image; the projecting parts being made to recede, and the receding parts brought into relief. In like manner, when several objects are combined in the same crossed pictures, their apparent relative distances are reversed; the remoter being brought nearer, and the nearer carried backwards; so that (for example) a Stereoscopic photograph representing a man standing in front of a mass of ice, shall, by the crossing of the picture, make the figure appear as if imbedded in the ice. A like conversion of relief may also be made in the case of actual solid objects by the use of the *Pseudoscope*; an instrument devised by Prof. Wheatstone, which has the effect of reversing the perspective projections of objects seen through it by the two eyes respectively; so that the interior or a basin or jelly-mould is made to appear as a projecting solid, while the exterior is made to appear hollow. Hence it is now customary to speak of *stereoscopic* vision as that in which the conception of the true natural relief of an object is called-up in the mind, by the normal combination of the two perspective projections formed of it by the right and left eyes respectively; whilst by *pseudoscopic* vision, we mean that 'conversion of relief' which is produced by the combination of two *reversed* perspective projections, whether these be obtained directly from the object (as by the Pseudoscope), or from 'crossed' pictures (as in the Stereoscope). It is by no means every solid object, however, or every pair of stereoscopic pictures, which can become the subject of this conversion. The degree of facility with which the 'converted' form can be apprehended by the Mind, appears to have great influence on the readiness with which the change is produced. And while there are some objects—the interior of a plaster mask of a face, for example—which can always be 'converted' (or turned inside-out) at once, there are others which resist such conversion with more or less of persistence.<sup>1</sup>

32. Now it is easily shown theoretically, that the picture of any projecting object seen through the Microscope with only the *right-hand* half of an objective having an even moderate angle of aperture, must differ sensibly from the picture of the same object received through the *left-hand* of the same objective; and further, that the difference between such pictures must increase with the angular aperture of the objective. This difference may be practically made apparent by adapting a 'stop' to the objective, in such a manner as to cover either the right or the left half of its aperture; and by then carefully tracing the outline of the object as seen through each half. But it is more satisfactorily brought into view by taking two Photographic pictures of the object, one through each lateral half of the objective; for these pictures when properly paired in the Stereoscope, give a magnified image *in relief*, bringing out on a large

---

figures with the axis of the eyes brought into convergence upon a somewhat nearer point, so that A is made to fall on B, and C on D.

<sup>1</sup> For a fuller discussion of this subject, see the Author's "Mental Physiology," §§ 168-170.



scale the solid form of the object from which they were taken. What is needed, therefore, to give the true Stereoscopic power to the Microscope, is a means of so bisecting the cone of rays transmitted by the objective, that of its two lateral halves one shall be transmitted to the right and the other to the left eye. If, however, the image thus formed by the *right* half of the objective of a Compound Microscope were seen by the *right* eye, and that formed by the *left* half were seen by the *left* eye, the result-ant conception would be not *stereoscopic* but *pseudoscopic*; the projecting parts being made to appear receding, and *vice versa*. The reason of this is that as the Microscope itself reverses the picture (§ 26), the rays proceeding through the *right* and the *left* hand halves of the objective must be made to cross to the *left* and the *right* eyes respectively, in order to correspond with the *direct* view of the object from the two sides; for if this second reversal does not take place, the effect of the first reversal of the images produced by the Microscope exactly corresponds with that produced by the 'crossing' of the pictures in the Stereoscope, or by that reversal of the two perspective projections formed direct from the object, which is effected by the Pseudoscope (§ 31). It was from a want of due appreciation of this principle (the truth of which can now be practically demonstrated, § 38), that the earlier attempts at producing a Stereoscopic Binocular Microscope tended rather to produce a 'pseudoscopic conversion' of the objects viewed by it, than to represent them in their true relief.

FIG. 18.



Naclet's Stereoscopic Binocular.

FIG. 17.

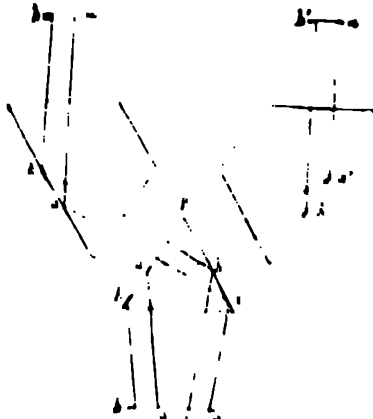

Arrangement of Lenses in Naclet's Stereoscopic Binocular Microscope.

3. *Naclet's Stereoscopic Binocular.*—The first really satisfactory solution of the problem was that worked out by MM. Naclet; whose original Binocular was constructed on the method shown in Fig. 17. The cone of rays issuing from the back lens of the objective meets the flat surface of a prism ( $p$ ) placed above it, whose section is an equal-

eral triangle; and is divided by reflection within this prism into two lateral halves, which cross each other in its interior. The rays  $a b$  that form the right half of the cone, impinging very obliquely on the internal face of the prism, suffer total reflection (§ 2), emerging through its left side perpendicularly to its surface, and therefore undergoing no refraction; whilst the rays  $a' b'$  forming the left half of the cone, are reflected in like manner towards the right. Each of these pencils is received by a lateral prism, which again changes its direction, so as to render it parallel to its original course; and thus the two halves  $a b$  and  $a' b'$  of the original pencil are completely separated from each other, the former being received into the left-hand body of the Microscope (Fig. 18), and the latter into its right-hand body. These two bodies are parallel; and, by means of an adjusting screw at their base, which alters the distance between the central and the lateral prisms, they can be separated from or approximated towards each other, so that the distance between their axes can be brought into exact coincidence with the distance between the axes of the eyes of the individual observer.—This instrument gives true Stereoscopic projection to the conjoint image formed by the mental fusion of the two distinct pictures; and with low powers of moderate angular aperture its performance is highly satisfactory. There are, however, certain drawbacks to its general utility. First, every ray of each pencil suffers *two* reflections, and has to pass through *four* surfaces; this necessarily involves a considerable loss of light, with a further liability to the impairment of the image by the smallest want of exactness in the form of either of the prisms. Second, the mechanical arrangements requisite for varying the distance of the bodies, involve an additional liability to derangement in the adjustment of the prisms. Third, the instrument can only be used for its own special purpose; so that the observer must also be provided with an ordinary single-bodied Microscope, for the examination of objects unsuited to the powers of his Binocular. Fourth, the parallelism of the bodies involves parallelism of the axes of the observer's eyes, the maintenance of which for any length of time is fatiguing.

34. *Wenham's Stereoscopic Binocular.*—All these objections are overcome in the admirable arrangement devised by the ingenuity of Mr. Wenham; in whose Binocular the cone of rays proceeding upwards from the objective is divided by the interposition of a prism of the peculiar form shown in Fig. 19, so placed in the tube which carries the objective (Figs. 20, 21 *a*) as only to interrupt one half,  $a c$ , of the cone, the other half,  $a b$ , going on continuously to the eye-piece of the principal or right-hand body *R*, in the axis of which the objective is placed. The interrupted half of the cone (Fig. 19, *a*), on its entrance into the prism, is scarcely subjected to any *refraction*, since its axial ray is perpendicular to the surface it meets; but within the prism it is subjected to two *reflections* at  $b$  and  $c$ , which send it forth again obliquely in the line  $d$  towards the eye-piece of the secondary, or left hand body (Fig. 20, *L*); and since at its emergence its axial ray is again perpendicular to the surface of the glass, it suffers no more refraction on passing out of the prism than on entering it. By this arrangement, the image received by the *right* eye is formed by the rays which have passed through the *left* half of the objective, and have come on without any interruption whatever; whilst the image received by the *left* eye is formed by the rays which have passed through the *right* half of the objective, and have been subjected to two reflections within the prism, passing through only *two* surfaces of glass. The adjustment for the variation of distance

between the axes of the eyes in different individuals, is made by drawing-out or pushing-in the eye-pieces, which are moved consentaneously



Wenham's Prism.

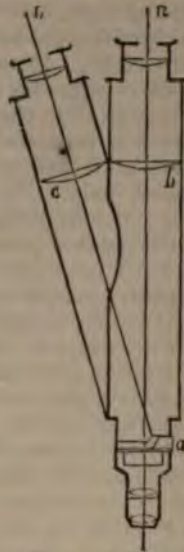

Wenham's Stereoscopic Binocular Microscope.



by means of a milled-head, as shown in Fig. 21.—Now, although it may be objected to Mr. Wenham's method (1), that as the rays which pass through the prism and are obliquely reflected into the secondary body, traverse a longer distance than those which pass-on uninterrupted into the principal body, the picture formed by them will be somewhat larger than that which is formed by the other set; and (2), that the picture formed by the rays which have been subjected to the action of the prism must be inferior in distinctness to that formed by the uninterrupted half of the cone of rays,—these objections are found to have no practicable weight. For it is well known to those who have experimented upon the phenomena of Stereoscopic vision (1), that a slight difference in the size of the two pictures is no bar to their perfect combination; and (2), that if one of the pictures be good, the full effect of relief is given to the image, even though the other picture be faint and imperfect, provided that the outlines of latter are sufficiently distinct to represent its perspective projection. Hence if, instead of the two equally *half-good* pictures which are obtainable by MM. Nacet's original construction, we had in Mr. Wenham's one *good* and one *indifferent* picture, the latter would be decidedly preferable. But, in point of fact, the deterioration of the *second* picture in Mr. Wenham's arrangement is less considerable than that of *both* pictures in the original arrangement of MM. Nacet; so that the optical performance of the Wenham Binocular is in every way superior. It has, in addition, these further advantages over the preceding,—*First*, the greater comfort in using it (especially for some length of time together), which results from the convergence of the axes of the eyes at their usual angle for moderately-near objects; *second*, that this Binocular arrangement does not necessitate a special instrument, but may be



applied to any Microscope which is capable of carrying the weight of the secondary body; the prism being so fixed in a movable frame that it may in a moment be taken out of the tube or replaced therein, so that when it has been removed, the principal body acts in every respect as an ordinary Microscope, the entire cone of rays passing uninterruptedly into it; and *third*, that the simplicity of its construction renders its derangement almost impossible.<sup>1</sup>

35. *Stephenson's Binocular*.—A new form of Stereoscopic Binocular has been recently introduced by Mr. Stephenson,<sup>2</sup> which has certain advantages over both the preceding.—The cone of rays passing upwards from the object-glass, meets a pair of prisms (A A, Fig. 22) fixed in the tube of the microscope immediately above the posterior combination of the objective, so as to catch the light-rays on their emergence from it; these it divides into two halves, each of which is subjected to internal reflection from the inner side of the prism through which it passes; and the slight separation of the two prisms at their upper end, gives to the two pencils B B, a divergence which carries them through two obliquely-placed bodies to their respective eye-pieces. By this internal reflection, a lateral reversal is produced, which antagonizes the lateral reversal of the Microscopic image; so that each eye receives the image formed by its own half of the objective, in the position required for the production of Stereoscopic relief by the mental combination of the two. As the cone of rays is equally divided by the two prisms, and its two halves are similarly acted-on, the two picture are equally illuminated, and of the same size; while the close approximation of the prisms to the back lens of the objective enables even higher powers to be used with very little loss of light or of definition, provided that the angles and surfaces of the prisms are worked with exactness. And as the two bodies can be made to converge at a smaller angle than in the Wenham arrangement, the observer looks through them with more comfort. But Mr. Stephenson's ingenious arrangement—which was first worked-out practically by the late Thomas Ross, and has since been very successfully constructed by Brown—<sup>3</sup> is liable to the great drawback of not being convertible (like Mr. Wenham's) into an ordinary Monocular, by the withdrawal of a prism; so that the use of this form of it will be probably restricted to those who desire to work stereoscopically with high powers.—In order to avoid slight errors arising from the impinging of the central ray of the cone, at its emergence from the objective, against the double edge of the

FIG. 22.



Stephenson's Binocular Prisms.

FIG. 23.

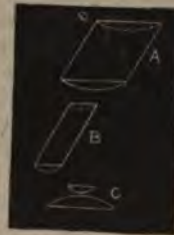

<sup>1</sup> The Author cannot allow this opportunity to pass without expressing his sense of the liberality with which Mr. Wenham freely presented to the Public this important invention, by which there can be no doubt that he might have largely profited if he had chosen to retain the exclusive right to it.

<sup>2</sup> "Monthly Microscopical Journal," Vol. iv. (1870), p. 61, and Vol. vii. (1872), p. 167.

Mr. Stephenson has devised a special form of sub-  
 (also made by Mr. Browning), which causes the illumi-  
 nance from the object in two separate pencils, which will  
 pass through the two prisms. This consists of two deep cylin-  
 ders, *a* and *b*, whose focal lengths are as 2.3 to 1, having their  
 axes disposed to each other, as shown in section at *c*; the larger  
 being placed with its plane side downwards, so as to re-  
 flect the mirror, or (which is preferable) direct from a lamp.  
 A stop, which slides a movable stop, with two circular open-  
 ings, is shown in Fig. 24. The lamp being placed in front of the instru-

FIG. 24.



Stephenson's Binocular.

FIG. 25.



Stephenson's Erecting Prism.

ment, the two apertures admit similar pencils of light from it; so that  
 each eye receives a completely equal illumination, and no confusion can  
 arise from the intermingling of the rays on the lower edges of the prisms.  
 With this arrangement the Podura-markings are shown as figured by the  
 line *Richard* (Plate II., fig. 2); while the curvatures of the scale  
 come out with the greatest distinctness peculiar to Binocular vision.  
 The greatest advantages attendant on Mr. Stephenson's  
 construction is its capability of being combined with an erecting arrange-  
 ment, which may be conveniently used. By the interposition of a plane  
 (still better) of a reflecting prism (Fig. 25), above the  
 binocular prisms, each half of the cone of rays is  
 its image is reversed vertically; the rays entering the  
 the surface *u n*, being reflected by the surface *A B*, so as  
 by the surface *A C* in the direction of the dotted lines.  
 and the left half cones are directed respectively into the  
 bodies, which are inclined at a convenient angle, as shown  
 —the stage being horizontal—the observer can look at  
 inclination which he finds most comfortable. The  
 the prism is worked can be varied to suit individual  
 it if it should be desired to use the instrument with  
 it will be found advantageous that the reflection from the  
 be at the polarising angle of  $56\frac{3}{4}^\circ$ , since, by substituting  
 a mirror or prism a highly polished mirror of black  
 can act as an analyser, with some decided advantages over  
 except in being incapable of rotation.—The great value



of the Erecting Binocular consists in its applicability to the picking out of very minute objects, such as *Diatoms*, *Polycystina*, or *Foraminifera*; and to the prosecution of minute dissections, especially when these have to be carried on in fluid. No one who has only thus worked *monocularly*, can appreciate the guidance derivable from *binocular* vision, when once the habit of working with it has been formed.

37. *Tolles' Binocular Eyepiece*.—An ingenious Eye-piece has been constructed by Mr. Tolles (Boston, U. S.), which, fitted into the body of a Monocular Microscope, converts it into an Erecting Stereoscopic Binocular. This conversion is effected by the interposition of a system of prisms similar to that originally devised by MM. Nacet (Fig. 17), but made on a larger scale, between an 'erector (resembling that used in the eye-piece of a day telescope) and a pair of ordinary Huyghenian eye-pieces; the *central* or dividing prism being placed at or near the plane of the secondary image formed by the erector, while the two eye-pieces are placed immediately above the two *lateral* prisms; and the combination thus making that division in the pencils forming the secondary image, which in the Nacet Binocular it makes in the pencils emerging from the objective.—As all the image-forming rays have to pass through the two surfaces of four lenses and two prisms, besides sustaining two internal reflections in the latter, it is surprising that Prof. H. L. Smith—while admitting a loss of light—should feel able to speak of the definition of this instrument as not inferior to that of either the Wenham or the Nacet Binocular. It is obviously a great advantage that this Eye-piece can be used with any microscope, and with Objectives of high power; but as its effectiveness must depend upon extraordinary accuracy of workmanship, its cost must necessarily be great.<sup>1</sup>

38. *Nacet's Stereo-pseudoscopic Binocular*.—An ingenious modification of Mr. Wenham's arrangement has been introduced by MM. Nacet; which has the attribute altogether peculiar to itself, of giving to the image either its true Stereoscopic projection, or a Pseudoscopic 'conversion of relief,' at the will of the observer. This is accomplished by the use of two prisms, one of them (Fig. 27, A) placed over the cone of rays proceeding upwards from the objective, and the other (B) at the base of the secondary or additional body, which is here placed on the right (Fig. 28). The prism A has its upper and lower surfaces parallel; one of its lateral faces is inclined at an angle of 45°, whilst the other is vertical. When this is placed in the position 1, so that its inclined surface lies over the *left half* (l) of the cone of rays, these rays, entering the prism perpendicularly (or nearly so) to its inferior plane surface, undergo total reflection at its oblique face, and being thus turned into the horizontal direction, emerge through the vertical surface at right angles to it. They then enter the vertical face of the other prism B; and, after suffering reflection within it, are transmitted upwards into the *right-hand*

FIG. 26.

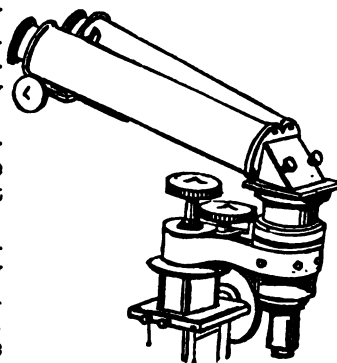

Stephenson's Erecting Binocular.

<sup>1</sup> See "American Journal of Science," vol. xxxviii. (1864), p. 111, and vol. xxxix. (1865), p. 212; and "Monthly Microsc. Journal," vol. vi. (1871), p. 45.

body  $r'$ , passing out of the prism perpendicularly to the plane of emersion, which has such an inclination that the right-hand or secondary body (B, Fig. 28) may diverge from the left or principal body at a suitable angle. On the other hand, the *right* half ( $r$ ) of the cone of rays passes upwards, without essential interruption, through the two parallel surfaces of the prism A, into the left-hand body ( $l'$ ), and is thus crossed by the other in the interior of the prism. But if the prism A be pushed over towards the right (by pressing the button  $a$ , Fig. 28), so as to leave the *left* half of the objective uncovered (as shown in Fig. 27, 2), that half ( $l'$ ) of the

FIG. 27.

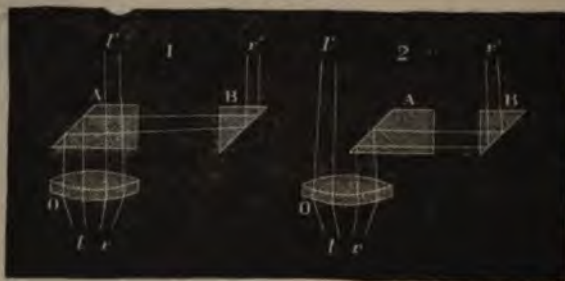

Arrangement of Prisms in Nachet's Stereo-pseudoscopic Binocular:—1, for Stereoscopic; 2, for Pseudoscopic effect.

cone of rays will go on without any interruption into the *left*-hand body ( $l'$ ), whilst the *right* half ( $r r'$ ) will be reflected by the oblique face of the prism into the horizontal direction, will emerge at its vertical face, and, being received by the second prism B, will be directed by it into the *right*-hand body ( $r'$ ).—Now, in the *first* position, the two halves of the cone of rays being made to cross into the *opposite* bodies, true Stereoscopic relief is given to the image formed by their recombination, just as in the arrangements previously described. But when, in the *second* position, each half of the cone passes into the body of its own side, so that the reversal of the images produced by the Microscope itself (§ 26) is no longer corrected by the crossing of the two pencils separated by the prism A, a Pseudoscopic effect, or 'conversion of relief,' is produced, the projections of the surface of the object being represented as hollows, and its concavities being turned into convexities. The suddenness with which this conversion is brought about, without any alteration in the position either of the object or of the observer, is a phenomenon which no intelligent person can witness without interest; whilst it has a very special value for those who study the Physiology and Psychology of Binocular vision.'—As originally constructed, the adjustment for dis-

<sup>1</sup> The result of the numerous applications which the Author has made of this instrument to a great variety of Microscopic objects has led to a confirmation of the principle of Pseudoscopic vision, stated at the conclusion of § 31.—Where, as in the case of the saucer-like disks of the *Arachnoidiscus* (Plate xii.), the real and the converted forms are equally familiar, the 'conversion' either of the convex exterior or the concave interior is made both suddenly and completely. In more complex and less familiar forms, on the other hand, the conversion frequently requires time; being often partial in the first instance, and only gradually becoming complete. And there are some objects which resist conversion altogether, the only effect being a confusion of the two images.

tance between the eyes was made by giving a horizontal traversing motion to the prism B and the secondary body placed above it, by means of a screw action. But this method was open to the two objections that the focal distance of the secondary body was thereby altered, and that the traversing fittings were liable to become loose by wear. To meet these, M. Nacet devised the construction represented in Fig. 28; in which the adjustment of the distance between the eye-pieces is effected by altering the angle of convergence between the bodies. This is done by turning the screw *v*, which is furnished with two threads of different speeds, whereby an inclination is given to the prism equal to half the angular displacement of the tube; an arrangement necessitated by the fact that the displacement of the rays reflected by a rotating surface is double the angle described by that surface.<sup>1</sup>—As an ordinary working instrument, however, this improved Nacet Binocular can scarcely be equal to that of Wenham or Stephenson; whilst it must be regarded as inferior to the former in the following particulars: *First*, that as the uninterrupted half of the cone of rays (when the interposed prism is adjusted for Stereoscopic vision) has to pass through the *two* plane surfaces of the prism, a certain loss of light and deterioration of the picture are necessarily involved; whilst, as the interrupted half of the cone of rays has to pass through *four* surfaces, the picture formed by it is yet more unfavorably affected; *second*, that as power of motion must be given to *both* prisms—to A, for the reversal of the images, and to B for the adjustment of the distance between the two bodies—there is a greater liability to derangement.<sup>2</sup> It does not give the equal illumination of Mr. Stephenson's, is less free from optical error, and cannot, like his, be used with high powers.



Nacet's Stereo-pseudo-scope Microscope.

39. The Stereoscopic Binocular is put to its most advantageous use, when applied either to *opaque* objects of whose solid forms we are desirous of gaining an exact appreciation, or to *transparent* objects which have such a thickness as to make the accurate distinction between their nearer and their more remote planes a matter of importance. That its best and truest effects can only be obtained by objectives not exceeding  $40^\circ$  of angular aperture, may be shown both theoretically and practically. Taking the average distance between the pupils of the two eyes as the base of a triangle, and any point of an object placed at the ordinary reading distance as its apex, the vertical angle inclosed between its two sides will be from  $12^\circ$  to  $15^\circ$ ; which, in other words, is the angle of divergence between the rays proceeding from any point of an object at

<sup>1</sup> "Monthly Microscopical Journal," Vol. i. (1869), p. 31.

<sup>2</sup> M. Nacet's arrangement, like Mr. Wenham's, can be adapted to any existing Microscope; and it seems peculiarly suitable to those of French or German construction, in which the body is much shorter than in the ordinary English models. For in the application of the Wenham arrangement to a *short* Microscope, the requisite distance between the eye-glasses of its two bodies can only be obtained by making those bodies converge at an angle so wide as to produce great discomfort in the use of the instrument, from the necessity of maintaining an unusual degree of convergence between the axes of the eyes.



the ordinary reading distance to the two eyes respectively. This angle, therefore, represents that at which the two pictures of an object should be shown in the Photographic Camera, in order to produce the effect of ordinary binocular vision without exaggeration; and it is the one which is adopted by Portrait-photographers, who have found by experience that a smaller angle makes the image formed by the combination of the pictures appear too flat, whilst a larger angle exaggerate its projection. Now, in applying this principle to the Microscope, we have to treat the two lateral halves (*L*, *R*, Fig. 29) of the objective as the two separate halves of a double portrait-camera; and to consider at what angle each half should be entered by the rays passing through it to form its picture.

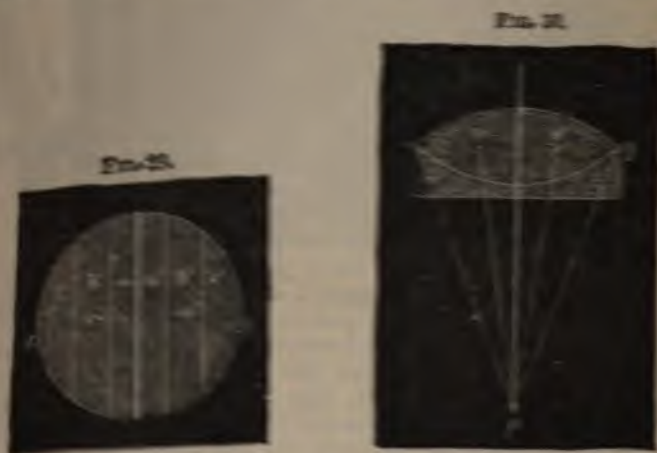

To any one acquainted with the principles of Optics, it must be obvious that the picture formed by each half of the objective must be (so to speak) an average or general resultant of the discircular pictures formed by its different parts. Thus, if we could divide the lateral halves or semi-lenses *L*, *R*, of the objective by vertical lines into the three bands *a b c* and *a' b' c'*, and could stop off the two corresponding bands on either side, so as only to allow the light to pass through the remaining pair, we should find that the two pictures we should receive of the object would vary sensibly, according as they are formed by the bands *a a'*, *b b'*, or *c c'*.

The writer has been surprised to find that the advantages of the Stereoscopic Binocular have been treated by certain Microscopists of eminence as altogether chimerical; no real difference (they assert) being discernible between the right-hand and the left-hand pictures.—This assertion is obviously placed upon the limitation of the use of the instrument to thin transparent objects. It is where the surface is uneven (as in the case with most Opaque objects), or where a Transparent object shows different structures in different planes of its thickness (as in layered preparations), that the special value of the Binocular shows itself. The dissimilarity of the two pictures of such objects received through the two halves of the objective, was long since demonstrated by Mr. Wenham, who, by covering with a diaphragm, first the right and then the left half of an objective of 1/4 inch focus and 68° aperture, and carefully drawing the two images thus obtained, found them to be such as would combine stereoscopically, so as to bring out the object in relief. See "Transact. of Microsc. Soc.," N. S., Vol. ii. (1854), p. 41.

For, supposing the pictures taken through the bands  $b b'$  to be sufficiently dissimilar in their prospective projections, to give, when combined in the Microscope, a sufficient but unexaggerated Stereoscopic relief, those taken through the bands  $a a'$  on either side of the centre would be no more dissimilar than two portraits taken at a very small angle between the cameras, and their combination would very inadequately bring out the effect of relief; whilst, on the other hand, the two pictures taken through the extreme lateral bands  $c c'$ , would differ as widely as portraits taken at too great an angle of divergence between the cameras, and their combination would exaggerate the actual relief of the object. Now, in each of the lateral halves, a spot  $v v'$  may be found by mathematical computation, which may be designated the *visual centre* of the whole Semi-lens; that is, the spot which, if all the rest of the semi-lens were stopped-off, would form a picture most nearly corresponding to that given by the whole of it. This having been determined, it is easy to ascertain what should be the angle of aperture ( $o p q$ , Fig. 30) of the entire lens, in order that the angles  $v p v'$  between the 'visual centres' of its two halves should be  $15^\circ$ . The investigation of this question having been kindly undertaken for the author by his friend Dr. Hirst, the conclusion at which he arrived was that the angle of aperture of the entire lens should be about  $36.6^\circ$ . This, which he gave as an *approximate* result only (the requisite data for a complete Mathematical solution of the question not having yet been obtained), harmonizes most remarkably with the results of experimental observations made upon *opaque objects of known shape*, with Objectives of different angular apertures; so that the Stereoscopic images produced by the several objectives may be compared, not only with each other, but with the actual forms which they ought to present. No better objects can be selected for this purpose than those which are *perfectly spherical*; such as various globular forms of the *Polycystina* (Plate xix.), or the Pollen-grains of the *Malvaceæ* and many other Flowering-plants. When either of these is placed under a Stereoscopic Binocular, provided with an objective of half-inch or 4-10ths inch focus having an angular aperture of  $80^\circ$  or  $90^\circ$ , the effect of projection is so greatly exaggerated, that the side next the eye, instead of resembling a hemisphere, looks like *the small end of an egg*. If, then, the aperture of such an objective be reduced to  $60^\circ$  by a diaphragm placed behind its back lens, the exaggeration is diminished, though not removed; the hemispherical circle now looking like *the large end of an egg*. But if the aperture be further reduced to  $40^\circ$  by the same means, it is at once seen that the hemispheres turned towards the eye are truly represented; the effect of spherical projection being quite adequate, without being in the least exaggerated. Hence it may be confidently affirmed—alike on theoretical and on practical grounds—that when an objective of wider angle than  $40^\circ$  is used with the Stereoscopic Binocular, the object viewed by it is represented in *exaggerated* relief, so that its apparent form must be more or less distorted.<sup>1</sup>—There are other substantial reasons, moreover, why

<sup>1</sup> This position has been contested by observers who have used high powers binocularly with *transparent* objects, and who, in their zeal for large angles of aperture, affirm that no exaggeration of Stereoscopic effect is produced by the combination of the two pictures thus obtained. But it seems to be forgotten that such objects *cannot* afford the actual measure of Stereoscopic effect, which is given by *opaque objects of known form*—as above described. And, so far as the Author's experience extends, every competent observer who makes use of a good



Objectives of limited angle of aperture should be preferred (save in particular cases) for use with the Stereoscopic Binocular. As the special value of this instrument is to convey to the mind a notion of the *solid forms* of objects, and of the relations of their parts to each other, not merely on the same, but on different planes, it is obvious that those Objectives are most suitable to produce this effect, which possess the greatest amount of *penetration* or *focal depth*; that is, which most distinctly show, not merely what is precisely in the focal plane, but what lies nearer to or more remote from the objective. Now, as will be explained hereafter (§ 158, II.), increase of the angle of aperture is necessarily attended with diminution of 'penetrating' power; so that an objective of 60° or 80° of aperture, though exhibiting minute surface-details which an objective of 40° cannot show, is much inferior to it in suitability to convey a true conception of the general form of any object, the parts of which project considerably above the focal plane or recede below it.

40. In concluding these general observations upon the use of the Stereoscopic Binocular, the Author would draw attention to two important advantages he has found it to possess; his own experience on these points being fully confirmed by that of others.—In the *first* place, the *penetrating power* or *focal depth* of the Binocular is greatly superior to that of the Monocular microscope; so that an object whose surface presents considerable inequalities is very much more distinctly seen with the former than with the latter. The difference may in part be attributed to the practical reduction in the angle of aperture of the Objective, which is produced by the division of the cone of rays transmitted through it into two halves; so that the picture received through each half of an Objective of 60° is formed by rays diverging at an angle of only 30°. But that this optical explanation does not go far to account for the fact, is easily proved by the simple experiment of looking at the object in the first instance through each eye separately (the prism being in place), and then with both eyes together; the distinctness of the parts which lie above and beneath the focal plane being found to be much greater when the two pictures are combined, than it is in either of them separately. In the absence of any adequate optical explanation of the greater range of focal depth thus shown to be possessed by the Stereoscopic Binocular, the Author is inclined to attribute it to an allowance for the relative distances of the parts, which seems to be unconsciously made by the *mind* of the observer, when the solid image is shaped out in it by the combination of the two pictures.—This seems the more likely from the *second* fact to be

---

half-inch Objective of 40° aperture—resembling the one first constructed to his order by Messrs. Powell and Lealand, and now procurable from several excellent makers—in the study of *Polycystina*, the smaller *Foraminifera*, or the larger discoidal *Diatoms*, viewed as opaque objects, soon becomes sensible of its advantage over Objectives of the same power but of larger angular aperture, in giving (1) unexaggerated relief, (2) much greater focal depth, and (3) such a working distance as enables *side-illumination* to be conveniently used. Having lately had occasion to give much attention to the structure and development of *Isthmia* (Chap. VII.), the writer has found great advantage from the use of a 1.4th objective, constructed by Zeiss, of what will be considered by many the absurdly low angle of 40°; the truth of the conception it gives of the *solid forms* of the frustules (when viewed as opaque objects), which is capable of easy verification, being in striking contrast with the violent exaggeration of relief which is produced when the same objects are similarly viewed through a 1.4th inch of 90° or 120° aperture. Doubtless the *elementary structure* of the frustule can only be properly studied by an Objective of large angle; but this is an altogether different inquiry.

now mentioned: namely, that when the Binocular is employed upon objects suited to its powers, the prolonged use of it is attended with *very much less fatigue* than is that of the Monocular Microscope. This, again, may be in some degree attributed to the division of the work between the two eyes; but the Author is satisfied that, unless there is a feeling of discomfort in the eye itself, the sense of fatigue is rather *mental* than *visual*, and that it proceeds from the constructive effort which the observer has to make, who aims at realizing the solid form of the object he is examining, by an interpretation based on the *flat picture* of it presented by his vision, aided only by the use of the focal adjustment, which enables him to determine what are its near and what its remote parts, and to form an estimate of their difference of distance. Now, a great part of this constructive effort is saved by the use of the Binocular; which at once brings before the Mind's eye the *solid image* of the object, and thus gives to the observer a conception of its form usually more complete and accurate than he could derive from any amount of study of a Monocular picture.<sup>1</sup>

---

<sup>1</sup> It has happened to the Author to be frequently called on to explain the advantages of the Binocular to Continental (especially German) *savans*, who had not been previously acquainted with the instrument. And he has been struck with finding that when he exhibited to them objects with which they had already become familiar by careful study, and of whose solid forms they had attained an accurate conception, they perceived no advantage in the Stereoscopic combination, seeing such objects *with* it (visually) just as they had been previously accustomed to see them (mentally) *without* it. But when he has exhibited to them suitable objects with which they had *not* been previously familiarized, and has caused them to look at these in the first instance *monocularly*, and then *stereoscopically*, he has never failed to satisfy them of the value of the latter method, except when some visual imperfection has prevented them from properly appreciating it. He may mention that he has found the wing of the little Moth known as *Zenzera Esculi*, which has an undulating surface, whereon the scales are set at various angles, instead of having the usual imbricated arrangement, a peculiarly appropriate object for this demonstration. The general inequality of its surface, and the individual obliquities of its scales, being at once shown by the Binocular, with a force and completeness which could not be attained by the most prolonged and careful Monocular study.



## CHAPTER II.

## CONSTRUCTION OF THE MICROSCOPE.

41. THE *optical* principles whereon the operation of the Microscope depends having now been explained, we have next to consider the *mechanical* provisions whereby they are brought to bear upon the different purposes which the instrument is destined to serve. And first, it will be desirable to state those general principles which have now received the sanction of universal experience, in regard to the best arrangement of its constituent parts.—Every *complete* Microscope, whether Simple or Compound, must possess, in addition to the lens or combination of lenses which affords its magnifying power, a *stage* whereon the Object may securely rest, a *concave mirror* for the illumination of transparent objects from beneath, and a *condensing-lens* for the illumination of opaque objects from above.

I. Now, in whatever mode these may be connected with each other, it is essential that *the Optical part and the Stage should be so disposed, as either to be altogether free from tendency to vibration, or to vibrate together*; since it is obvious that any movement of one, in which the other does not partake, will be augmented to the eye of the observer in proportion to the magnifying power employed. In a badly-constructed instrument, even though placed upon a steady table resting upon the firm floor of a well-built house, when high powers are used, the object is seen to oscillate so rapidly at the slightest tremor—such as that caused by a person walking across the room, or by a carriage rolling-by in the street—as to be frequently almost indistinguishable: whereas in a well-constructed instrument, scarcely any perceptible effect will be produced by even greater disturbances. Hence, in the choice of a Microscope, it should always be subjected to this test, and should be unhesitatingly rejected if the result be unfavorable. If the instrument should be found free from fault when thus tested with *high* powers, its steadiness with *low* powers may be assumed; but, on the other hand, though a Microscope may give an image free from perceptible tremor when the lower powers only are employed, it may be quite unfit for use with the higher.—The Author has found no test for steadiness so *crucial* as the vibration of a paddle-steamer going at full speed against a head-sea; and the result of his comparison between the two principal ‘models’ generally used in this country will be stated hereafter (§ 49).

II. The next requisite is *a capability of accurate adjustment to every variety of focal distance, without movement of the object*. It is a principle universally recognized in the construction of good Microscopes, that the *stage* whereon the object is placed should be a *fixture*; the movement by which the focus is to be adjusted being given to the optical portion. This movement should be such as to allow free range from a minute fraction

of an inch to three or four inches, with equal power of obtaining a delicate adjustment at any part. It should also be so accurate, that the optic axis of the instrument should not be in the least altered by any movement in a vertical direction; so that if an object be brought into the centre of the field with a low power, and a high power be then substituted, the object should be found in the centre of *its* field, notwithstanding the great alteration in the focus. In this way much time may often be saved by employing a low power as a *finder* for an object to be examined by a higher one; and when an object is being viewed by a succession of powers, little or no readjustment of its place on the stage should be required. For the Simple Microscope, in which it is seldom advantageous to use lenses of shorter focus than 1-4th inch (save where 'doublets' are employed, § 23), a *rack-and-pinion* adjustment, if it be made to work both tightly and smoothly, answers sufficiently well; and this is quite adequate also for the focal adjustment of the Compound body, when objectives of low power only are employed. But for any lenses whose focus is less than half-an-inch, a 'fine adjustment,' or 'slow motion,' by means of a *screw-movement* operating either on the object-glass alone or on the entire body, is of great value; and for the highest powers it is quite indispensable. In some Microscopes, indeed, which are provided with a 'fine adjustment,' the rack-and-pinion movement is dispensed with, the 'coarse adjustment' being given by merely *sliding* the body up and down in the socket which grasps it; but this plan is only admissible where, for the sake of extreme cheapness or portability, the instrument has to be reduced to the form of utmost simplicity.

III. Scarcely less important than the preceding requisite, in the case of the Compound Microscope, especially with the long body of the ordinary English model, is *the capability of being placed in either a vertical or a horizontal position, or at any angle with the horizon*, without deranging the adjustment of its parts to each other, and without placing the eye-piece in such a position as to be inconvenient to the observer. It is certainly a matter of surprise, that some Microscopists, especially on the Continent, should still forego the advantages of the inclined position, these being attainable by a very small addition to the cost of the instrument; but the inconvenience of the vertical arrangement is much less when the body of the microscope is short, as in the ordinary Continental model; and there are many cases in which it is absolutely necessary that the stage should be horizontal. This position, however, can at any time be given to the stage of the inclining Microscope, by bringing the optic axis of the instrument into the vertical direction. And even with the stage horizontal, a convenient inclination may be given to the visual axis, not merely by such modifications in general construction as constitute the special features of the erecting Binocular of Mr. Stephenson (§ 36) or the Inverted Microscope of Dr. Lawrence Smith (§ 80), but by the application to the ordinary vertical body of the erecting eye-piece of M. Natchet (§ 86).—In ordinary cases an inclination of the body at the angle of about  $55^\circ$  to the horizon will usually be found most convenient for unconstrained observation; and the instrument should be so constructed, as, when thus inclined, to give to the stage such an elevation above the table, that, when the hands are employed at it, the arms may rest conveniently upon the table. In this manner a degree of support is attained, which gives such free play to the muscles of the hands, that movements of the greatest nicety may be executed by them; and the fatigue of long-continued observation is greatly diminished. Such minutiae may appear



too trivial to deserve mention; but no practised Microscopist will be slow to acknowledge their value.—For other purposes, again, it is requisite that the Microscope should be placed horizontally, as when the Camera Lucida is used for drawing or measuring. It ought, therefore, to be made capable of every such variety of position; and the Stage must of course be provided with some means of holding the object, when it is itself placed in a position so inclined that the object would slip down unless sustained.

IV. The last principle on which we shall here dwell, as essential to the value of a Microscope designed for ordinary work, is *Simplicity in the construction and adjustment of every part*. Many ingenious mechanical devices have been invented and executed, for the purpose of overcoming difficulties which are in themselves really trivial. A moderate amount of dexterity in the use of the hands is sufficient to render most of these superfluous; and without such dexterity, no one even with the most complete mechanical facilities, will ever become a good Microscopist. Among the conveniences of simplicity, the practised Microscopist will not fail to recognize the saving of time effected by being able quickly to set up and put away his instrument. Where a number of parts are to be screwed together before it can be brought into use, interesting objects (as well as time) are not unfrequently lost; and the same cause will often occasion the instrument to be left exposed to the air and dust, to its great detriment, because *time* is required to put it away; so that a slight advantage on the side of simplicity of arrangement often causes an inferior instrument to be preferred by the working Microscopist to a superior one. Yet there is, of course, a limit to this simplification; and no arrangement can be objected-to on this score, which gives advantages in the examination of difficult objects, or in the determination of doubtful questions, such as no simpler means can afford.—The meaning of this distinction will become apparent, if it be applied to the cases of the Mechanical Stage and the Achromatic Condenser. For although the Mechanical Stage may be considered a valuable aid in observation, as facilitating the finding of a minute object, or the examination of the entire surface of a large one, yet it adds nothing to the clearness of our view of either; and its place may in great degree be supplied by the fingers of a good manipulator. On the other hand, the use of the Achromatic Condenser not only contributes very materially, but is absolutely indispensable, to the formation of a perfect image, in the case of many objects of a difficult class: the want of it cannot be compensated by the most dexterous use of the ordinary appliances; and consequently, although it may fairly be considered superfluous as regards a large proportion of the purposes to which the Microscope is directed, whether for investigation or for display, yet as regards the particular objects just alluded to, it must be considered as no less necessary a part of the instrument than the Achromatic Objective itself. Where expense is not an object, the Microscope should doubtless be fitted with *both* these valuable accessories; where, on the other hand, the cost is so limited that only *one* can be afforded, *that* one should be selected which will make the instrument most useful for the purposes to which it is likely to be applied.

---

In the account now to be given of the principal forms of Microscope readily procurable in this country, it will be the Author's object, not so much to enumerate and describe the various patterns which the several



Makers of the instrument have produced; as, by selecting from among them those examples which it seems to him most desirable to make known, and by specifying the peculiar advantages which each of these presents, to guide his readers in the choice of the *kind* of microscope best suited on the one hand, to the class of investigations they may be desirous of following out, and, on the other, to their pecuniary ability. He is anxious, however, that he should not be supposed to mark any preference for the particular instruments he has selected, over those constructed upon the same general plan by other Makers. To have enumerated them all, would obviously be quite incompatible with the plan of his Treatise; but he has considered it fair (save in one or two special cases) to give the preference to those Makers who have worked out their own plans of construction, and have thus furnished (to say the least) the general designs which have been adopted with more or less of modification by others.

## SIMPLE MICROSCOPES.

42. Under this head, the common *Hand-Magnifier* or pocket lens first claims our attention; being in reality a Simple Microscope, although not commonly accounted as such. Although this little instrument is in every one's hands, and is indispensable to the Naturalist—furnishing him with the means of at once making such *preliminary* examinations as often afford him most important guidance—yet there are comparatively few who know how to handle it to the best advantage. The chief difficulty lies in the steady fixation of it at the requisite distance from the object; especially when the lens employed is of such short focus, that the slightest want of exactness in this adjustment produces evident indistinctness of the image. By carefully resting the hand which carries the glass, however, against that which carries the object, so that both, whenever they move, shall move together, the observer, after a little practice, will be able to employ even high powers with comparative facility. The lenses most generally serviceable for Hand-magnifiers range in focal length from two inches to half an inch; and a combination of two or three such in the same handle, with an intervening perforated plate of tortoiseshell (which serves as a diaphragm when they are used together), will be found very useful. When such a magnifying power is desired, as would require a lens of a quarter of an inch focus, it is best obtained by the substitution of a 'Coddington' (§ 24), or, still better, of the Browning or the Steinheil Doublet (§ 25), for the ordinary double-convex lens. The handle of the magnifier may be pierced with a hole at the end, most distant from the joint by which the lenses are attached to it; and through this may be passed a wire, which, being fitted vertically into a stand or foot, serves for the support of the magnifying lenses in a horizontal position, at any height at which it may be convenient to fix them. Such a little apparatus is a rudimentary form (so to speak) of what is commonly understood as a Simple Microscope; the term being usually applied to those instruments in which the magnifying powers are supported otherwise than in the hand, or in which, if the whole apparatus be supported by the hand, the lenses have a fixed bearing upon the object.

43. *Ross's Simple Microscope.*—This instrument holds an intermediate place between the Hand-magnifier and the complete microscope; being, in fact, nothing more than a lens supported in such a manner as to be capable of being readily fixed in a variety of positions suitable for dissecting and for other manipulations. It consists of a circular brass

foot, which is a screw and short conical pillar (Fig. 31), which is 'sprung' at its upper end, so as to grasp a second tube, also 'sprung,' by the drawing-out of which the pillar may be elongated to about 3 inches. This carries at its upper end a pointed socket, through which a square bar (which is made long and rather stiffly) and one end of this bar carries a ring, to which is attached a ring for holding the lenses. By lengthening or shortening the pillar, by turning the angle which the square bar makes with its summit, and by sliding that bar through the socket, any position and elevation may be given to the lens, that may be desired for the purposes to which it may be most usefully applied. It is to be remarked in all instances, that the ring which carries the lens (and by means of its joint) be placed horizontally. At A is seen the microscope which adapts it best for picking out minute shells, or for examining minute pulsations; the sand or drawings to be examined being placed upon a piece of black paper, and raised upon a book, a box, or any other support, to such a height that when the lens is adjusted

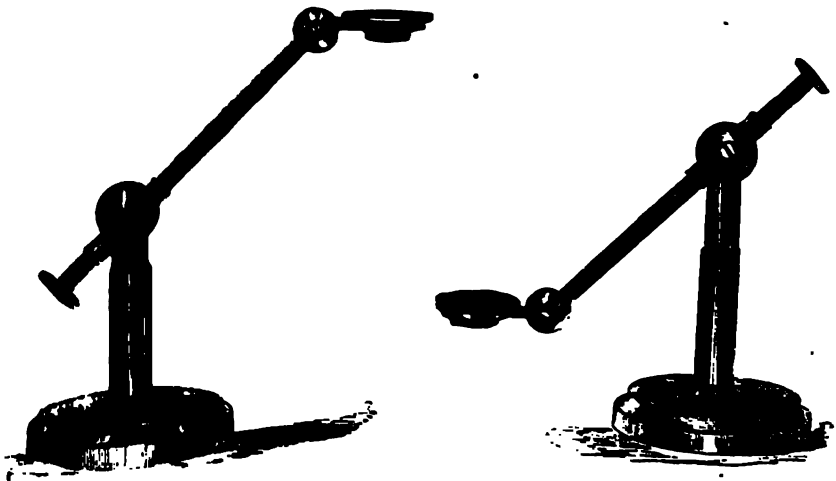

Ross's Simple Microscope.

Thereby, the eye may be applied to it continuously without unnecessary fatigue. It will be found advantageous that the foot of the microscope should rest upon the paper over which the objects are spread, as it is thus easy to shake this from time to time in order to bring a fresh portion of the matters to be examined into view; and generally speaking, it is more convenient to place it on the opposite side of the object, than on the same side with the observer. At B is shown the position in which it may be most conveniently set for the dissection of objects upon a plate or trough, the sides of which, being higher than the object, would prevent the use of any magnifier mounted on a stand. The powers usually supplied with this instrument are 100, 200, 300, and a second of either a half or a quarter of an inch. The whole is made to pack into a small flat case, the carrying of which is a great recommendation. Although the uses of the instrument are greatly limited by its want of stage,

mirror, etc., yet, for the class of purposes to which it is suited, it has advantages over perhaps every other form that has been devised.

44. *Quekett's Dissecting Microscope*.—By the Scientific investigator who desires a large flat stage, combined with portability, the arrangement devised by Mr. John Quekett (Fig. 32) will be found extremely convenient. The Stage, which constitutes the principal part of the apparatus, is a plate of brass (bronzed<sup>1</sup>) nearly six inches square, screwed to a piece of mahogany of the same size, and about 5-8ths of an inch thick; underneath this is a folding flap four inches broad, attached on each side by hinges; and the two flaps are so shaped, that, when folded together, one lies closely upon the other, as shown at B, Fig. 32, whilst, when opened, as shown at A, they give a firm support to the stage at a convenient height.<sup>2</sup> At the back of the stage-plate is a round hole, through which a tubular stem works vertically with a rack-and-pinion movement, carrying at its summit the horizontal Arm for the magnifying powers; and into the underside of the stage-plate there screws a stem

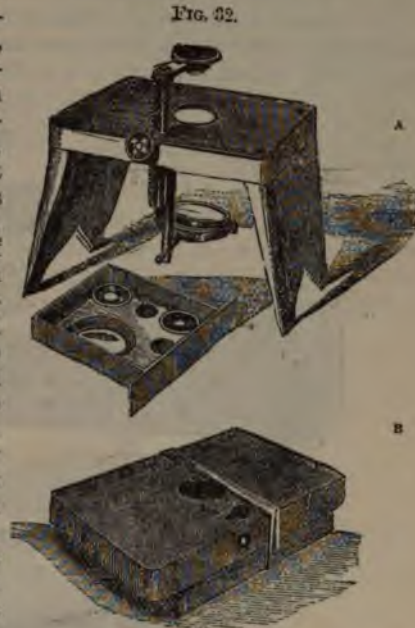

Quekett's Dissecting Microscope, set up for use at A, and packed together at B.

which carries the mirror-frame. From this frame the mirror may be removed, and its place supplied by a convex lens, which serves as a condenser for opaque objects, its stem being then fitted into a hole in the stage, at one side or in front of its central perforation. The instrument is usually furnished with three magnifiers—namely, an *inch* and a *half-inch* ordinary lenses, and a *quarter-inch* Coddington; and these (or the combinations of equivalent foci already mentioned, § 25), will be found to be the powers most useful for the purposes to which it is specially adapted. As a black back-ground is often required in dissecting objects which are not transparent, this may be most readily provided by attaching a disk of *dead-black* paper to the back of the mirror. The lenses, mirror, condenser, vertical stem, and milled-head, all fit into a drawer which shuts into the underside of the stage; so that, when packed together, and the flaps kept down by an elastic band, as shown at B, Fig. 32, the instrument is extremely portable, furnishing (so to speak) a case for itself. It may be easily made with an additional arm carrying a light Compound body,

<sup>1</sup> The Stage-plate is sometimes made of plate-glass or ebonite; and this is decidedly advantageous where Sea-water or Acids are used.

<sup>2</sup> The Stage is now more generally supported, either (as in Mr. Ladd's model) on four legs of strong brass wire, which screw into its underside, and are packed in its drawer when dismounted; or (as made by Mr. Swift and Messrs. Parkes of Birmingham) on four brass legs which fold beneath it;—either of these constructions remedying the chief disadvantage of the original model, which consists in the exclusion of *side* light from the mirror.

furnished with objectives suitable for the examination of dissections or other preparations made upon the stage, without disturbing them by moving to another instrument.

45. *Siebert and Kraft's Dissecting Microscope*.—In making minute dissections, however, the hands are most advantageously rested, not on the stage itself, but on supports at a level intermediate between that of the

FIG. 33.



Siebert and Kraft's Dissecting Microscope, as opened for use.

FIG. 34.

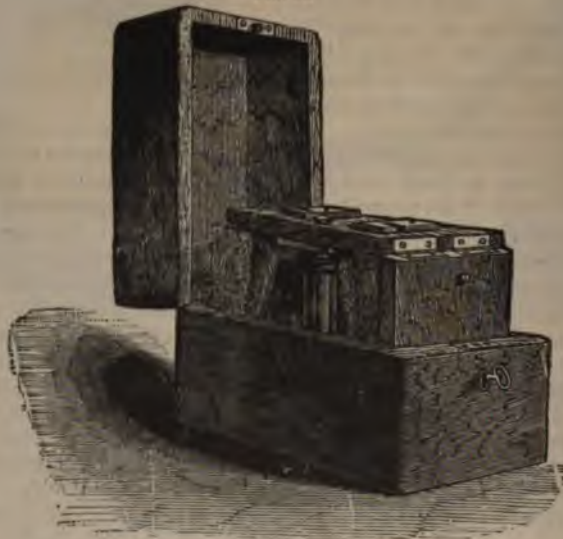

Siebert and Kraft's Dissecting Microscope, as folded in case.

stage and that of the table. Such a support, in some Continental Dissecting Microscopes—as those of Nachet and Zeiss—is attached to each side of the stage of an ordinary Simple Microscope; but this arrangement is subject to the disadvantage of causing the whole weight of the hands to bear on the stage, so as, by depressing it, to throw the object out of focus, unless the stage be made of extraordinary solidity, or be supported in front as



well as behind. Hence the Author regards the arrangement adapted by Messrs. Siebert and Kraft (Fig. 33) as preferable; in which the supports for the hands are oblique wooden blocks, altogether disconnected from the stage. These, being hinged to the wooden base of the pillar, can be made to turn up for portability (as shown in Fig. 34), so that the instrument packs into a very small compass.

46. *Laboratory Dissecting Microscope.*—Where, on the other hand, portability may be altogether sacrificed, and the instrument is to be adapted to the making of large dissections under a low magnifying power, some such form as is represented in Fig. 35—constructed by Messrs. Baker on the basis of that devised by Prof. Huxley for the use of his Practical Class at South Kensington—will be found decidedly preferable. The framework of the instrument is solidly constructed in mahogany, all its surfaces being blackened; and is so arranged as to give two uprights for the support of the stage, and two oblique rests for the hands. Close to

FIG. 35.



Laboratory Dissecting Microscope.

the summit of each of these uprights is a groove into which the stage-plate slides; and this may be either a square of moderately thick glass, or a plate of ebonite having a central perforation into which a disk of the same material may be fitted so as to lie flush with its surface; one of those being readily substituted for the other, as may best suit the use to be made of it. The magnifier is carried on an arm working on a racked stem, which is raised or lowered by a milled-head pinion attached to a pillar at the further right-hand corner of the stage. The length of the rack is sufficient to allow the arm to be adjusted to any focal distance between 2 inches and 1-4th of an inch. But as the height of the pillar is not sufficient to allow the use of a lens of 3 inches focus (which is very useful for large dissections) the arm carrying the lenses is made with a double bend, which, when its position is reversed (as is readily done by unscrewing the milled-head that attaches it to the top of the racked stem), gives the additional inch required. As in the Quekett Microscope, a Compound body may be easily fitted, if desired, to a separate arm capable of being pivoted on the same stem. The mirror frame is fixed to the wooden basis of the instrument; and places for the magnifiers are made in grooves beneath the hand-



supports.—The advantages of this general design have now been satisfactorily demonstrated by the large use that has been made of it; but the details of its construction (such as the height and slope to be given to the hand-rests) may be easily adapted to individual requirements.

47. *Beck's Dissecting Microscope, with Nachet's Binocular.*—A substantial and elaborate form of Dissecting Microscope, devised by the late Mr. R. Beck, is represented in Fig. 36. From the angles of a square mahogany base, there rise four strong brass pillars, which support, at a height of 4 inches, a brass plate  $6\frac{1}{2}$  inches square, having a central aperture of 1 inch across;

FIG. 36



Beck's Dissecting Microscope, with Nachet's Binocular Microscope.

upon this rests a circular brass plate, of which the diameter is equal to the side of the preceding, and which is attached to it by a revolving fitting that surrounds the central aperture, and can be tightened by a large milled-head beneath; whilst above this is a third plate, which slides easily over the second, being held down upon it by springs which allow a movement of  $1\frac{1}{4}$  inch in any direction. The top-plate has an aperture of  $1\frac{1}{4}$  inch for the reception of various glasses and troughs suitable for containing objects for dissection; and into it can also be fitted a spring-holder, suitable to receive and secure a glass slide of the ordinary size. By turning the large circular plate, the object under observation may be easily made to rotate, without disturbing its relation to the optical portions of the instrument; whilst a traversing movement may be given to it in any direction, by acting upon the smaller plate. The left-hand back pillar contains a triangular bar with rack-and-pinion movement for focal adjustment, which carries the horizontal arm for the support of the magnifiers; this arm can be turned away towards the left side, but it is provided with a stop which checks it in the opposite direction, when the magnifier is exactly over the centre of the stage-aperture. Beneath this aperture is a concave mirror, which when not in use, lies in a recess in the mahogany base, so as to leave the space beneath the stage entirely free to receive a box containing apparatus; whilst from the right-hand back corner there can be raised a stem carrying a side condensing-lens, with a ball-and-socket movement. In addition to the Single lenses and Coddington ordinarily used for the purposes of dissection, a Binocular arrangement was devised by Mr. R. Beck,<sup>1</sup> on the principle applied by MM. Nachet, about the same date, in their Stereo-pseudoscopic Microscope (§ 38). Adopting Mr. Wenham's method of allowing half the cone of rays to proceed to one eye without interrup-

<sup>1</sup> "Transactions of the Microscopical Society," N. S., Vol. xii. (1864), p. 3.

tion, he caused the other half to be intercepted by a pair of prisms disposed as in Fig. 27, 2, and to be by them transmitted to the other eye. It will be readily understood that this arrangement, though *pseudoscopic* for the Compound Microscope, is *stereoscopic* for the Simple Microscope, in which there is no reversal of the pictures; and the Author can testify to the fidelity of the effect of relief obtainable by Mr. R. Reck's apparatus, which, being carried on an arm superposed upon that which bears the magnifier, can be turned aside at pleasure. But he has found its utility to be practically limited by the narrowness of its field of view, by its deficiency of light and of magnifying power, and by the inconvenience of the manner in which the eyes have to be applied to it.—An arrangement greatly superior in all these particulars having been since worked out by M.M. Nacet, the Author has combined this with Mr. R. Beck's Stand and finds every reason to be satisfied with the result; the solidity of the stand giving great firmness, whilst the size of the stage-plate affords ample room for the hands to rest upon it. The Objective in Nacet's arrangement is an achromatic combination of three pairs, having a clear aperture of nearly 3-4ths of an inch, and a power about equal to that of a single lens of one inch focus; and immediately over this is a pair of prisms, each resembling A, Fig 27, having their inclined surfaces opposed to each other, so as to divide the pencil of rays passing upwards from the objective into two halves. These are reflected horizontally, the one to the right and the other to the left; each to be received by a lateral prism corresponding to B, and to be reflected upwards to its own eye, at such a slight divergence from the perpendicular as to give a natural convergence to the axes when the eyes are applied to the eye-tubes superposed on the lateral prisms—the distance between these and the central prisms being made capable of variation, as in the Compound Binocular of the same makers (§ 38). The magnifying power of this instrument may be augmented to 35 or 40 diameters, by inserting a *concave* lens in each eye-piece, which converts the combination into the likeness of a Galilean telescope (or opera-glass); and this arrangement (originally suggested by Prof. Brücke of Vienna) has the additional advantage of increasing the distance between the object and the object-glass, so as to give more room for the use of dissecting instruments.—To all who are engaged in investigations requiring very minute and delicate dissection, the Author can most strongly recommend M.M. Nacet's instrument. No one who has not had experience of it, can estimate the immense advantage given by the Stereoscopic view, not merely in appreciating the solid form of the object under dissection, but also in precisely estimating the relation of the dissecting instrument to it in the *vertical* direction. This is especially important when fine scissors are being used horizontally; since the course of the section can thus be so regulated as to pass through the plane desired, with an exactness totally unattainable by the use of any monocular magnifier.

48. *Field's Dissecting and Mounting Microscope*.—This instrument, constructed on the plan of Mr. W. P. Marshall, is a combination of a Dissecting Microscope with a set of apparatus and materials for the preparation and mounting of microscopic objects; the whole being packed in a small cubical case about seven inches each way, convenient both for general use, but more particularly as a travelling case for carrying the several requisites for the examination and mounting of objects into the country, or to the seaside.—The Microscope can be used either Simple or Compound, as shown in Fig. 37; and is fitted with a mirror, side-condenser, and stage-

with metal and glass stage-plates; a dissecting-trough, lined with wax, fits into the opening of the stage. The Simple Microscope, for dissecting and mounting, is shown in the lower figure; it may be used singly or in combination, which are carried by the larger arm of the stand. The Compound body, as shown in the upper figure, has a divided objective, and three powers; the nose is made with the standard screw, and carries the best class objectives. A telescope sliding arm, fitting into the side of the stage, can also be used to carry the simple microscope, as well as a larger low-power lens, that serves also as a

FIG. 37.



Field's Dissecting and Mounting Microscope.

holder; and the arm can be readily fixed in any desired position. The dissecting objects away from the instrument. A watch-glass holder, which fits into the glass stage-plate, gives the means of sliding steadily upon the glass stage-plate, in any direction objects that are under examination in a watch-glass holder. A turn-table for mounting purposes is carried upon a long spindle through the corner of the stage (as shown in the lower figure), and is supported by the stand serving as a support for the hand whilst using the microscope. The top is made of the size of an ordinary glass slide, and the microscope is held upon it by an india-rubber band. A hot plate fits into the side of the stage, and is heated by a spirit-lamp placed in the position of the mirror, which is then turned to one side; and the larger arm

serves also as a watch-glass holder for preparing crystals by evaporation over the spirit-lamp. A selection of materials required in preparing and mounting objects is supplied in a rack of bottles sliding in the case; and a set of instruments—dissecting-needles, knife, forceps, dipping tubes, brushes, etc.—with a supply of cover-glasses, cells, etc., are carried in the three drawers; all the different contents of the case being readily accessible when it is set open, as shown in the lower part of the figure.<sup>1</sup>

## COMPOUND MICROSCOPES.

49. Of the various forms of Compound Microscope, the greater number may be grouped with tolerable definiteness into *three* principal Classes: the *First* consisting of those high-class instruments in which the greatest possible perfection and completeness are aimed at, without regard to cost; the *Second* including those which are adapted to all the ordinary requirements of the observer, and which can be fitted with the most important Accessories;<sup>2</sup> whilst to the *Third* belong the Students' and Educational Microscopes, in which simplicity and cheapness are made the primary considerations. Besides these, there is a class of Microscopes devised for *special* purposes, but not suited for ordinary use.—In all, save the last, the same basis of support is adopted; namely, a tripod 'foot,' carrying a pair of uprights, between which the Microscope itself is swung in such a manner, that the weight of its different parts may be as nearly as possible balanced above and below the centres of suspension in all the ordinary positions of the instrument. This double support was first introduced by Mr. George Jackson, who substituted two pillars (a form which Messrs. Beck retain in their Large Microscope, Plate VII., and is now adopted by Messrs. Ross, Plate v.) for the single pillar, connected with the Microscope itself by a 'cradle joint,' which was previously in use, and which is still employed in many Continental models (Fig. 45). But in place of pillars screwed into the tripod base, the uprights are now usually cast in one piece with the base, both for greater solidity and for facility of construction (Fig. 39); while in most of the more recent models an open framework is adopted (more or less resembling that first devised by Mr. Swift, Fig. 50), which combines great steadiness with lightness. Messrs. Powell and Lealand, it will be observed, adopt a tripod support of a different kind (Fig. 48 and Plate VI.); still, however, carrying out the same fundamental principle of swinging the Microscope itself between two centres. An entirely new and very effective mode of swinging the body has lately been introduced by Mr. George Wale of New York (Fig. 44).—Two different modes of giving support and motion to the 'body' will be found to prevail. In the first, which may be called the *Ross* model (as having been originally adopted by Mr. Andrew Ross), the 'body' is attached at its base only to a transverse 'arm,' which, being pivoted to the top of the 'stem,' is raised or lowered with it by the rack-and-pinion action that works in the pillar to which the stage is fixed (Fig. 52). The fundamental objection to this method is, that unless the

<sup>1</sup> The whole of this apparatus is supplied complete at the moderate cost of £4. or, without the Compound body and inclined movement of the stand, at £2 10s.

<sup>2</sup> It is true that the most important of these accessories *may* be applied to some of the smaller and lighter kind of Microscopes; but when it is desired to render the instrument complete by the addition of them, it is far preferable to adopt one of those larger and more substantial models, which have been devised with express reference to their most advantageous and most convenient employment.



transverse arm and the body are constructed with great solidity, the absence of support along the length of the latter leaves its ocular end subject to vibration, which becomes unpleasantly apparent when high powers are used, giving a dancing motion to the objects. With the view of preventing this vibration, the top of the 'body' is sometimes connected with the back of the transverse arm by a pair of oblique 'stays' (Fig. 48); but the usual plan is to obtain the requisite firmness by the thickness and weight of the several parts. In the other, which may be termed the *Jackson* model, and which was first adopted by Mr. James Smith (the predecessor of Messrs. Beck), the body is supported along a great part of its length on a solid 'limb' whereby its 'vibration' is reduced to a *minimum*; and the rack, which is acted on by a pinion working in that limb, is attached to the body itself; a construction that gives a great smoothness and easiness of working (Plate VII.).—Having made use of instruments constructed by the best makers on both models, the Author has no hesitation in expressing his preference for the second, which is now employed by most English makers (having been adopted by Messrs. Ross themselves in their more recent instruments), and by nearly all American. He regards it as certain that greater freedom from vibration can be obtained in lightly-framed Microscopes constructed on the *Jackson* model, than in any but the most solid and cumbersome of the old *Ross* pattern; and feels assured that the principle of supporting the 'body' along a great part of its length (which may be applied in a variety of modes) will in time supersede that of fixing it by its base alone, which is obviously the mode *least* adapted to prevent vibration at its ocular end.

In describing the Instruments which he has selected as typical of the several groups above enumerated, the Author wishes not to be understood as giving any special preference to these, above what may be the equally good instruments of other Makers. The number of those who now construct really excellent Microscopes has of late years increased greatly; but their models are for the most part copied more or less closely from those previously adopted for their high-class Microscopes by the three principal Firms which long had exclusive possession of the field. Where any individual Maker has introduced a real novelty, either in plan of construction, or in simplification leading to reduction of price, the Author has thought this worthy of special notice; whilst the limits within which he is restricted oblige him to content himself with a bare mention of other Makers whose productions are favorably known to him. It will be found most advantageous to commence with the Educational and Students' Microscopes, as the most simple in construction; and to proceed from these through the *Second* to the *First-Class* Microscopes, reserving to the last the group of instruments adapted for *Special* purposes.

#### THIRD-CLASS MICROSCOPES.

50. Very important contributions to our knowledge of Nature have unquestionably been made by the assistance of instruments not surpassing the least perfect of those now to be described. And there is this advantage in commencing Microscope-work with a simple and low-priced instrument—that the risk of injury to a more costly Microscope, which necessarily arises from want of experience in its use, is avoided; whilst the inferior instrument will still be found serviceable for many purposes,

after a better one has been acquired. Microscopes, of whatever Class, should be provided with the 'Society's screw' now used not only by British and American, but also by several Continental Makers; so that any of their Objectives may be fitted to them. (See Note, p. 58.)

*Educational Microscopes.*

51. *Field's Educational Microscope.*—This instrument is known as the 'Society of Arts Microscope,' in consequence of its having gained the medal awarded by that Society, in 1855 (at the suggestion of the Author) for the best *three-guinea* Compound Microscope that was then produced. It has two Eye-pieces, and two achromatic Objectives, Condenser, Live-box, etc., and retains its place amongst useful instruments of low price. It is within the knowledge of the Author, that the production of this instrument has greatly promoted the spread of Microscopy among many to whom the pursuit has proved most valuable as a refreshing and elevating occupation for hours that might have been otherwise either spent in idleness or turned to much worse account.

52. *Crouch's Educational Microscope.*—This is a very simple and at the same time serviceable, instrument (Fig. 38); well suited for the display of Botanical objects, small Insects or parts of larger ones, Zoophytes and Polyzoa that may be picked up on almost any sea-shore, or the Circulation in a Frog's foot. In order to minimize its cost, the ordinary modes of focal adjustment are dispensed with; the 'coarse' adjustment being made by sliding the body through the tube which grasps it, and which is lined with velvet to secure a smooth and equable 'slip;' and the 'fine' by slightly drawing-out the Eye-pieces. This method answers very well for the low powers for which this instrument is intended; and it has the advantage of not allowing the adjustment which a Teacher has made, to be readily disturbed by the Pupils to whom an object is being exhibited. It is provided with a side-condenser for illuminating opaque objects; and with a diaphragm-plate fitted into the aperture of the stage, and which is adapted also to receive a polarizing prism and spot-lens.<sup>1</sup>

53. *Parkes's Educational Microscope.*—Such as desire a large and more substantial instrument, which may be advantageously used for higher powers, and made to serve a greater variety of purposes, will find the Microscope represented in Fig.



Crouch's Educational Microscope.

<sup>1</sup> The cost of this instrument, with a dividing object-glass of  $\frac{1}{2}$  inch and 1 inch focus, in mahogany case, is only £2 10s.

This book is the property of  
 COOPER MEDICAL COLLEGE,  
 SAN FRANCISCO, CAL.  
 and is not to be removed from  
 the Library Room by any person  
 under any pretext whatever.  
 FIG. 38.

39 very suitable to such requirements. It is solidly built, without being unduly weighty, carries a body of full diameter (which can be lengthened by a draw-tube to ten inches), and stands well upon its base. The 'coarse' adjustment is made (as in the preceding case) by sliding the body within the tube that grasps it, the lining of which with cloth makes it work very easily (Fig. 39); but a rack and pinion movement may be added at a

FIG. 37.

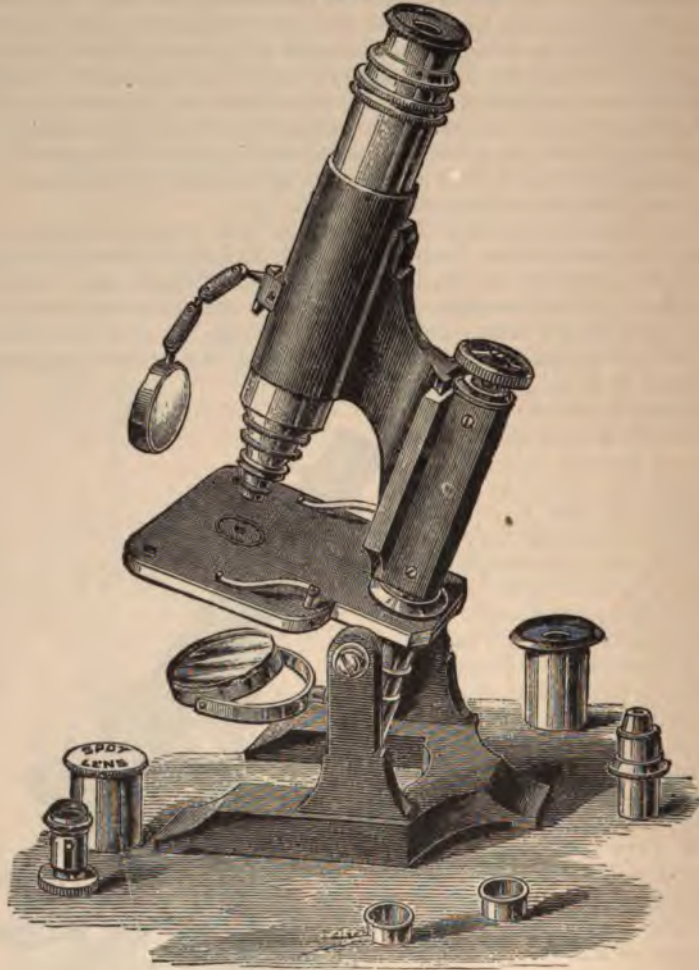

Parkes's Educational Microscope.

small additional cost. The 'fine' adjustment is made by a screw (turned by the milled-head at the top of the vertical pillar), which acts on the carriage of the body; and as this carriage slides between dove-tailed grooves, the adjustment is made with entire freedom from 'twist.' The Microscope is furnished with two eye-pieces, of which the lower is preferable for objects requiring good definition; whilst the higher gives a flat field of eight inches

diameter, suitable for Sections of Wood and other like objects viewed with the low-power objective. The powers usually supplied are a separating combination of 2 inch and 1 inch, which, by the use of the two eye-pieces and the draw-tube, gives a range of magnifying power from 15 to 110 diameters; and a 1-4th inch of 70° aperture, from which, by the same means, a range of magnifying power can be obtained from 140 to 450 diameters. The aperture of the stage is furnished with a cylindrical fitting, which carries two diaphragms (one with a small aperture, the other with a larger) for regulating the quantity of light reflected from the mirror to the object, a ground-glass for the equable diffusion of the light over a large field, and a 'spot-lens' for black-ground illumination. The mirror is plane on one side, and concave on the other; and a condenser for opaque objects is attached by a jointed arm, giving universal motion, to the tube that carries the body. The Objectives of this Microscope, as of most of those constructed by the same Makers, are made to fit into the nozzle of the body by their 'patent sliding adapter,' which enables one power to be exchanged for another without any screwing or unscrewing. But their Microscopes can be used with any objective carrying the 'Society's screw,' by simply unscrewing the special nozzle from the end of the body. And by sliding the special nozzle upon either of its own objectives, this may be used with any other instrument furnished with that screw.<sup>1</sup>

#### *Students' Microscopes.*

54. The principle is now universally recognized, that the form of Microscope best adapted to the wants of the Medical or Biological Student, is one in which simplicity and compactness of general construction are combined with excellence in optical performance. The demand for instruments of this kind was first met by Continental Opticians; and at the time when Messrs. Ross, Powell and Lealand, and Smith and Beck—then almost the only constructors of Microscopes in this country—sold no Objectives but such as would stand the highest tests and were costly in proportion, recourse was necessarily had, by such as desired simpler and cheaper instruments, to the Opticians of France and Germany; among whom M. M. Nacet, Oberhauser (succeeded by Hartnack), and Kellner (succeeded by Gundlach), long shared the chief English demand. A large number of new Makers, however—many of them trained in one or other of the three principal establishments just named—have now entered the field; and have put themselves in fair competition with Continental Opticians, and with each other, alike in the excellence of their work (both mechanical and optical), and in moderation of price. A distinct class of 'Students' Microscopes' of English construction, more or less framed upon Continental models, has thus come into general use; affording ample choice, in the varieties of their pattern, to such as may have a preference for one or other of them as most suitable to the work on which they may be engaged. With few exceptions, the Microscopes properly belonging to this class have the small short 'body' (capable, however, of being lengthened by a 'draw-tube') of the Continental instruments; and this is grasped by a tube attached to the 'limb,' in such a manner as

---

<sup>1</sup> The price of this Microscope with the above-named Accessories, in a well-made mahogany Case, is £8 10s. An Objective of 1-6th inch focus, giving a maximum power of 560 degrees, or one of 1-7th inch giving a maximum power of 700 diameters, may be substituted for the 1-4th inch at a very small advance of cost. A Polariscope and Achromatic Condenser can be easily added.



from vibration even when high powers are used. In such models, such as that of Messrs. Baker (Fig. 40), the movement for the 'coarse' adjustment, which is effected by sliding the body through the tube which holds it, is lubricated with cloth or velvet; but the rack movement is provided at a small cost. A 'fine' adjustment for the carriage of a micrometer-screw worked by a milled-head is also provided, and this movement may be given in different ways. In some models, the screw is usually contained within the pillar of the body, the arm or limb to which the carriage of the body is attached, the head being at its summit (Figs. 40, 45); this answer is made to prevent 'twist' of the movable portion (which would displace the image), without interfering with its vertical motion. By many British and American makers, the micrometer is made to act on a tube within the 'nose' of the body, the objective is screwed; this being raised or lowered, either directly within the arm, which is acted-on by the milled-head (as in the original Ross model, Fig. 52), or by a shorter lever (as in Beck's Large Microscope, Plate VII.). This method is attended with disadvantages: (1) that the focussing tube which carries the objective can scarcely be made to work with the requisite facility, owing to its liability to 'twist,' which becomes very perceptible after much use; (2) that by the vertical movement thus given to the focussing tube, the working length of the body, and consequently the magnifying power, goes change in every adjustment for focus. The plan of fine adjustment which has been adopted from an American model by Messrs. Baker (Plate V.) and is employed in Wale's New Working Microscope (Fig. 46), seems to the Author in every way preferable. Here a lever is attached within the limb, and acted-on by a micrometer-screw at its summit, which gives motion to a long slide, working in dove-tailed grooves, and carrying the racked slide which carries the body; and this can be made to work very easily, without either 'twist' or 'lost time.'—The Stage of a Microscope is often a simple plate of brass, with a couple of screws for holding down the object-slide; but in some models (Figs. 40, 45) there is an 'upper stage-plate' of glass, rotating in the optic axis of the body. Into the aperture of the stage a cylindrical fitting is usually inserted, for the purpose of receiving the Accessories required for giving correct illumination; the most indispensable of these being Diaphragms of different apertures. These should be so fitted that they can be brought flush with the level of the stage; the limitation of the illuminating aperture for the purpose of obtaining the best definition being much more effectively made by a very small aperture (not exceeding a large pin-hole) placed to the under side of the object-slide, than by a wider aperture at some distance beneath it. For the same reason, if a rotating 'diaphragm-plate' (§ 98) be employed, containing a graduated series of apertures, it should be attached to the under side of the Stage itself, and not to the bottom of the cylindrical fitting beneath it. For perfect regulation of the light, nothing is so effective as the 'Iris-diaphragm' (§ 98); and this, as Mr. Wale has shown (§ 60), may be constructed so cheaply, that its general adoption seems very desirable.—The mirror should be double, one of its surfaces plane and the other concave; and it should be attached (1) that its distance from the stage may be varied sufficiently,

to allow the rays reflected from the concave side to be either brought to a focus on the object, or to give a uniform illumination over a larger field, and this alike with the parallel rays of daylight, and the diverging rays of a lamp; and (2) that it may be thrown so far out of the optic axis, as to reflect rays of considerable obliquity. The first of these objects is answered by making the mirror-frame slide upon a stem fixed into the bottom of the pillar (Fig. 41); but this does not give sufficient obliquity. The second is readily provided-for by attaching the mirror-frame to a swinging-bar, pivoted to the under side of the stage (Fig. 42); this gives any amount of obliquity, but does not enable the distance of the mirror from the stage to be varied. If the mirror-frame be made to slide on a stem, it should be mounted on a jointed arm, so as to be made capable of reflecting very oblique light; or, if attached to a swinging bar, this bar should be made capable of elongation by a sliding piece working in a dove-tail groove (as in Wale's Microscope, Fig. 44), so as to allow its distance from the stage to be varied.—A very ingenious arrangement of the rotating 'upper stage' has been devised by Mr. John Phin (of New York). It is so fitted with a short tube, that it may be slid into the cylindrical fitting, not only from above, but also from *below*; and as the object-slide rests upon the springs which press it upwards against the stage-plate, not only may light of any degree of obliquity be thrown upon it, but the advantage of a 'safety-stage' (§ 117) is obtained, since the springs that support the slide readily yield to any pressure exerted on it by the objective. A Student's Microscope fitted with this form of rotating stage, and with either Wenham's 'disk illuminator,' or 'Woodward's prism' (§ 101), and having the mirror hung in the manner just recommended, will be found capable—if furnished with good Objectives—of resolving all but the most difficult Diatom-tests.

55. In regard to the qualities of the Objectives desirable for a Student's Microscope, the Author feels assured that he expresses the conviction of the most experienced *workers* in various departments of Biological inquiry, when he re-affirms the doctrine of which nearly half a century's varied experience has satisfied him, but which has been of late vehemently contested (not always very cautiously) by Microscopists whose range of study has been less extended—that *good definition, with moderate angle of aperture*, is the essential requisite; Objectives of this class being not only much more easy to use by the inexperienced, but frequently also giving much more information even to the experienced (in virtue of their greater 'penetration' or 'focal depth'), than can be obtained from Objectives of the very wide angles required for the resolution of difficult diatom-tests (see § 161). Every one who is at all conversant with the recent history of Micro-Zoology, Micro-Botany, Micro-Geology, or Animal or Vegetable Histology, must know that at least ninety-nine hundredths of the enormous additions made to each of these departments of inquiry during the last quarter of a century, have been worked-out by Objectives of the kind here recommended; and those who affirm that all this work is so imperfect that it will have to be done over again with Objectives of excessively wide aperture, have to prove the fact. Doubtless *new methods of preparation* are constantly revealing novelties in whole classes of objects which (it was supposed) had been already studied exhaustively; and no one can affirm that he has made out everything, in any object, which it is capable of being thus made to show. But the Author feels confident that no such extension of our knowledge is likely to take place in this direction, as will require the habitual use of the very

... which certain Microscopists, especially in  
 ... In confirma-  
 ... authorities may  
 ... one can call in  
 ... p. 10:—  
 ... of the object-glass.  
 ... This is a defect in  
 ... Such glasses admit much  
 ... of an exceedingly delicate nature  
 ... For *gen-  
 ... aperture  
 ... and upwards  
 ... and can struc-  
 ... adapted  
 ... who has been trained  
 ... of the present  
 ... "Practical Histology and Pathology."  
 ... he thinks of  
 ... some Histological  
 ... *resolving  
 ... of Histologist."*  
 ... everywhere will know as a most able  
 ... who has lately produced  
 ... 48 beautiful quarto-plates) on  
 ... "makes a point, in his  
 ... that Microscopic observa-  
 ... do not  
 ... the Student's Micro-  
 ... with a power of 1-4th or 1-5th  
 ... furnishing all that  
 ... "not with any dis-  
 ... of the various magnificent instru-  
 ... a common  
 ... with whom I habitu-  
 ... put forth  
 ... expensive instru-*

The cost of the Objective of 1-4th inch focus and 1/70" aperture, made by Mr. Powell of Boston, is 70 dollars about £14; which would purchase a very good Student's Microscope, with a series of excellent Objectives up to 1-10th magnification.

Now that the requirements of a Student's Microscope are so definitely understood, the Author would suggest whether it would not be better that a new standard screw of much smaller size than the Society's should be adopted for it, so as to enable Students' Objectives to be set in the small light mounts used on the Continent, instead of in the massive mounts which the Society's screw necessitates; especially as, on the construction already recommended (§ 17) no adjustment for thickness of covering-glass is required, even for high powers. A small light nose-piece, for change of Objectives, could then be added at a low cost,—to the great convenience of the worker. Such Microscopists as, commencing with Student's Microscopes, afterwards provide themselves with more complete instruments, would readily employ their Students' objectives with the latter by means of an adapter. But the Author's experience would lead him to recommend any one engaged in research to keep his Student's Microscope, with its own series of objectives, constantly on his table; and to have recourse to his larger instrument, with its first-class Objectives and varied methods of Illumination, only for the more complete scrutiny of the preparations he has made with his model.

56. *Baker's Student's Microscope.*—Most of the conditions above specified as desirable, are well fulfilled in the instrument represented in Fig. 40; which might easily be brought into entire conformity with them. It is extremely light and handy; and is so well hung as to be very steady in all positions. It is provided with a rotating glass stage; and this carries a cylindrical fitting (not represented in the figure) for the usual Accessories.<sup>1</sup>



Baker's Student's Microscope.



Collins's Student's Microscope.

57. *Collins's Student's Microscope.*—This instrument (Fig. 41) is constructed on a plan altogether different; the body having the diameter of that of the larger Microscopes by the same maker (Fig. 49), so as to receive their eye-pieces, and being capable of elongation by a draw-tube to the full ordinary length. It is provided with a rack-movement acting on a carriage attached along the length of the body (as in the Jackson model); and the top of this carries the milled-head for the fine adjustment, which acts upon a lever near the bottom of the carriage, so as to raise or lower a focussing tube within the nozzle of the body.

58. *Pillischer's International Microscope.*—The Student who may be willing to incur a slight additional expense, for the sake of obtaining a substantial and well-constructed instrument, cannot do better (in the Author's judgment) than possess himself of the International Microscope of Mr. Pillischer (Fig. 42), in which the advantages of British and Continental methods are ingeniously combined. The pillar, carrying a

<sup>1</sup> The price of this instrument, with one Eye-piece and two Objectives (1 inch and 1-4th inch), in Case, is 5 guineas; or, with rack movement for coarse adjustment, 6 guineas.



rack-movement with double milled-head, is swung on two uprights set on a solid foot, in such a manner as to be well balanced; and at the top of the racked stem is the milled-head that works the screw for fine adjustment, raising or lowering the horizontal arm which carries the body, without twist or loss of time. This arm carries a tube firmly screwed into it, through which the body slides; and while this arrangement, by giving additional support to the lower part of the body, effectually antagonizes vibration, it allows the body to be raised to a height that permits the use of objectives of 3 or 4 inches' focus, for which the rack-movement is not long enough to provide. On the outside of this tube is a clip having attached to it a jointed arm that carries a condens-

FIG. 42.



Pillischer's International Microscope.

FIG. 43



Ross's (Zentmayer) Student's Microscope.

ing lens for opaque objects; which, by raising or lowering the clip, or turning it round the tube, can be brought into any required position. The stage is simple, and carries a rotating diaphragm-plate on its under side. The mirror is attached to a swinging bar, which might easily be made to elongate like that of the Wale Microscope (§ 60).—The special merit of this model (of which the Author can speak from considerable experience of its use), lies in the facility with which both the coarse and the fine movements may be worked with either of the hands, while resting on the table in the position most convenient for manipulating the

object on the stage, an advantage which every real *worker* with a simple instrument of this class will appreciate.<sup>1</sup>

59. *Ross's (Zentmayer) Student's Microscope*.—Another instrument of superior make (Fig. 43), has lately been introduced by Messrs. Ross, with the view of affording to the Student the advantage of the 'swinging tail-piece for oblique illumination,' devised by Mr. Zentmayer; of which a fuller description will be given in its application to their First-class Microscope (§ 72). This tail-piece swings round a pivot which serves for the attachment of the stage to the limb; and at the back of the limb is a milled-head working on the projecting end of this pivot, by tightening which the stage may be firmly fixed in its ordinary horizontal position, whilst by loosening it the stage may be made to incline to one side or the other. The 'tail-piece' carries, between the mirror and the stage, a 'sub-stage,' fitting into which may be screwed an ordinary 1 inch,  $1\frac{1}{2}$  inch, or 2 inch Objective, which answers the purpose of an Achromatic condenser; and when a pencil of light reflected from the mirror has been made by it to focus in the object, the swinging of the 'tail-piece' to one side or the other will give any degree of obliquity to the illuminating pencil that may be desired, without throwing its focus off the object, as this lies in the plane of the centre round which it turns. The 'tail-piece' may even be carried round *above* the stage, so that light of various degrees of obliquity may be concentrated upon opaque objects. The object-platform of the stage is of glass, and rotates round the optic axis of the microscope; so that the object may be illuminated by oblique rays from any azimuth. A mechanical stage may be added, if desired.—The workmanship of this simple model is of the highest class; and there is little real *work*, of which, in the hands of an observer who knows how to turn the instrument to the best account, it may not be made capable, by the addition of a Polariscope, Paraboloid, and other accessories, which its Sub-stage adapts it to receive.<sup>2</sup>

60. *Wale's New Working Microscope*.—A Student's Microscope lately brought out by Mr. George Wale (U. S.), deserves special notice, on account of several ingenious improvements which he has introduced into its construction.—In the first place, the 'limb' which carries the body and the stage, instead of being swung by pivots—as ordinarily—on the two lateral supports (so that the balance of the Microscope is greatly altered when it is much inclined), has a circular groove cut on either side, into which fits a circular ridge cast on the inner side of each support. The two supports, each having its own fore-foot, are cast separately (in iron), so as to meet to form the hinder foot, where they are held together by a strong pin; while by turning the milled-head on the right support, the two are drawn together by a screw, which thus regulates the pressure made by the two ridges that work into the two grooves on the limb. When this pressure is moderate, nothing can be more satisfactory than either the smoothness of the inclining movement, or the balancing of the instrument in all positions; while, by a slight tighten-

---

<sup>1</sup> The cost of the above Microscope, with two Eye-pieces (B and C), and two Objectives (5-8ths and 1-7th inch) giving—with the Draw-tube—a range of powers from 50 to 420 diameters, packed in a very compact Case, is only £7 10s. 0d., or, with the addition of an A Eye-piece, a  $1\frac{1}{2}$  or 2-inch Objective, Polarizing Apparatus, and Beale's Drawing Camera, 10 guineas.

<sup>2</sup> The price of the Microscope, as above figured, in Case, is 10 guineas. None but first-class Objectives are supplied by Messrs. Ross; but the Student who finds these too costly may obtain elsewhere such as suit his requirements.

ing of the screw, it can be firmly fixed either horizontally, vertically, or at any inclination. The 'coarse' adjustment is made by a smooth-working rack; whilst the 'fine,' made by a milled-head at the back of the 'limb,' raises or lowers the body by acting on the slide that carries the rack-and-pinion movement. The body is furnished with a long draw-tube, which carries a screw at its lower end for the reception of objectives of foci too long to be worked from the nose of the outside body. The stage, though thin enough to admit very oblique light, is very firm;



FIG. 41.

Wale's New Working Microscope.

it is circular, and has an all-round groove near its edge, alike on its upper and its under side. Into this groove there fits a spring-clip for holding down the slide upon the stage; and this may not only be turned round into any position *above* the stage, but may be reversed so as to hold the slide against its *under* side, thus enabling light of any degree of obliquity to be thrown on the object. A removable 'Iris-diaphragm' (§ 98), which is made to open or close by a screw-action, is fitted into the stage in such a manner that its aperture is very close to the under side of the

object-slide—an arrangement than which, in the Author's opinion, nothing can be better. This may be replaced by a cylindrical fitting for the reception of a Polariscope, Paraboloid, etc. The double mirror is carried upon an arm which swings on a pivot from the front of the limb beneath the stage, and is capable of extension by a dovetail sliding bar.—Altogether, this instrument (so far as its mechanical arrangements are concerned), comes nearer than any others that the Author has seen, to his idea of a *model Student's Microscope*.<sup>1</sup>

61. *Nachet's Student's Microscope*.—This instrument deserves special mention for certain peculiarities of construction which distinguish it from the ordinary Continental model of Microscopes of this class. While most of these can be used only in the vertical position, the Microscope of M. M. Nachet is attached to the supporting pillar by a cradle-joint, which allows it to be inclined at any angle. The body is furnished with a draw-tube, by which it is shortened for packing; and is embraced by a tube which carries the rack, so that it is well supported, and may be readily drawn out and replaced by the Binocular already described. (§ 38, Fig. 28). The 'slow motion' is given by a milled-head placed at the top of the sliding-stem, so as to be near that which gives the rack-and-pinion adjustment. The chief peculiarity of this instrument, however, lies in its Stage, which the Author has no hesitation in pronouncing to be the *most perfect of its kind* that has been yet devised.<sup>2</sup> Its base is formed of a thick plate,  $3\frac{1}{2}$  inches square, having a large circular aperture; and on this is superposed a circular plate of 3 inches in diameter, to which a rotary movement, concentric with the optic axis of the Microscope, can be given with great facility. In this circular plate a disk of thin plate-glass is cemented with black cement, the united thickness of the two around the central aperture being not more than 1-8th of an inch, so that light of the greatest obliquity can be transmitted to the object from beneath. The rotating plate is furnished with a projection at the back, to which is attached a strong V-shaped pair of springs, having their extremities armed beneath with small ivory knobs, which press down on the Object-carrier. This last consists of a brass frame furnished with tongues and springs projecting forward for the reception of the slide, and also with a pair of knobs, to which the fingers may be applied in giving motion to it; whilst the frame incloses a piece of plate-glass a little thicker than itself. Thus the under surface of the glass-plate of the Object-carrier slides over the upper surface of the circular glass stage-plate; being held down upon it and retained in any position by the pressure of the ivory knobs. The advantages of this arrangement lie (1) in the perfect facility with which the Object-carrier may be moved, and the steadiness with which it keeps its place when not unduly weighted; (2) in the facility with which it can be readjusted, in case the movement should become too easy, by bending down the V springs; and (3) by the absence of liability to derangement by rust—a point of great importance when work is being done with sea-water or chemicals. The front portion of the rotating plate bears a small pro-

<sup>1</sup> This Microscope, with two Eye-pieces, and with fairly good Objectives of 2-8ds and 1-5th inch, is sold in New York for 35 dollars, or little more than £7. It could probably be made in this country (if there were a considerable demand for it) for 5 guineas.

<sup>2</sup> This Stage, which, on the Author's recommendation, has been copied, first by Mr. Crouch, and now by other English opticians, seems to have been originally invented by Mr. Zentmayer of Philadelphia.



jecting piece on either side, into which may be screwed a pin that carries a sliding-spring; this arrangement is suited for securing a Zoophyte-trough or other piece of apparatus not suitable to being received by the object carrier, which can be easily slipped away from beneath the ivory knobs, thus leaving the stage free. To the under side of the stage is firmly pivoted a broad bar, into which is screwed a short sprung tube, that becomes exactly concentric with the optic axis of the instrument, when the bar (which is shown turned away in the figure) is pushed beneath the stage until checked by a firm stop; and as this bar is composed of two pieces, held together by a pair of screws working through slots, the centering of the tube may be precisely readjusted if it should at any time become faulty. Into this tube may be inserted another that carries either (1) a Diaphragm, sliding with caps of differ-

FIG. 45.



Hachel's Student's Microscope.

FIG. 46.



Browning's Rotating Microscope.

ent apertures; (2) a Polarizing prism; (3) a Ground-glass for diffusing the light, which may be either plane, or a plano-convex lens ground on its flat side which is directed upwards; (4) an Achromatic Condenser; and (5) a Glass Cone, having its apex pointing downwards, and a large black spot in the centre of the convex base directed towards the object, which gives an excellent 'black-ground' illumination. Lastly, the Mirror is attached to a stem which is so jointed as to enable it to reflect rays of very great obliquity.—To those who wish a compact instrument of great completeness and capability, which may be worked advantageously even with high powers, the Author can strongly recommend this

Microscope. The Objectives supplied with it are of great excellence and very moderate cost, and are quite adequate for all the ordinary purposes of scientific investigation.

62. *Browning's Rotating Microscope.*—The peculiarity of this instrument is that, as in many of the Continental models, the object-platform (B), with the limb carrying the body above it, revolves together; whilst the lower plate of the stage (c), with any apparatus fitted into it, as likewise the mirror, remains fixed. Thus the object is enabled to receive illumination in every azimuth without any derangement either in its centering, or in its focal adjustment. The body is supported, as in the Jackson model, upon a limb, A, which is firmly fixed to the rotating plate B of the stage. In the simplest form of the instrument, shown in the figure, the rotation is effected by pressing a finger on the projecting pins attached to B; but if required, B can be made to move by a pinion and toothed wheel, with graduated scale attached; and a sub-stage for carrying illuminating apparatus can be fixed to an arm below c. This Microscope is further characterized by the solidity of its several parts, and the care taken in its construction to secure it against derangement from an accidental strain. It is particularly adapted to the use of those who work with high powers upon objects requiring the varied illumination for which this rotating arrangement gives special facilities.

63. *Crouch's Student's Binocular.*—This instrument (Plate III.) was devised at a time when the construction of the Binocular was still almost exclusively confined to the makers of First-class instruments; and it had the great merit of bringing within reach of the Student a convenient and well-constructed Binocular, at a moderate cost. With the improvements it has since received, it still remains one of the best instruments of its class; and the Author, after considerable use of it, can strongly recommend it to such as desire to possess a Binocular at once cheap, good, and portable. Its general arrangement is shown in Plate III., but a mechanical stage can be substituted, if desired. The rotating stage and object-holder resemble those of MM. Nacet's Microscope (Fig. 45).—An Achromatic Condenser, Paraboloid, Polarizing apparatus, etc., can be added to this instrument; or it may be fitted with Mr. Crouch's 'Universal Sub-stage Illuminator,' which, like that of Mr. Swift (Fig. 85), combines the different Accessories ordinarily required for the examination of transparent objects.<sup>1</sup>

64. *Baker's Student's Erecting Binocular.*—With a special view to the wants of Students in various departments of Biology, Messrs. Baker have adapted a Stephenson Binocular (§ 35) to the stand of their Student's Microscope, as shown in Fig. 47; with which the stand of their Laboratory Dissecting Microscope (Fig. 35) may be so combined as to afford the requisite support to the hands, when they are engaged in dissecting (or otherwise manipulating) objects on the stage of the Binocular. An ordinary Monocular body may be readily substituted for the Binocular; and the same Eye-pieces and Objectives serve for both. The low cost at which this instrument is made, will doubtless cause many to possess themselves of it, whose pursuits will be specially facilitated by its use.<sup>2</sup>

<sup>1</sup> The price of this instrument, with one pair of Eye-pieces, two Objectives (a best 1-inch and a 1-4th of 110°), and a Condenser for opaque objects, in case, is £12 15s. 0d.

<sup>2</sup> The price of this Binocular, with one pair of Eye-pieces, a dividing Objective of 1 inch and 2 inches, and a 1-4th inch of 70°, in Case, is 10 guineas.

## PLATE III.



CROUCH'S STUDENTS' BINOCULAR.



Excellent Students' Microscopes are now produced by many other Makers; among whom Messrs. Beck should be particularly mentioned, as having led the way in supplying low-priced but really serviceable instruments, such as could at that time only be obtained on the Continent. Their 'Economic' Microscope framed on the Continental model, and furnished with good Objectives of 1 inch and 1-4th inch, is sold for 5 Guineas; and other Objectives specially constructed for it, ranging to the 1-16th inch, with a complete set of Accessories, are supplied at a very moderate cost. The same Makers supply an 'Economic' Wenham Binocular, having two pairs of Eye-pieces, three Objectives, a glass rotating Stage, and a jointed lengthening arm to the Mirror (which allows it to be used *above* the Stage for the illumination of opaque objects) for 10 Guineas.—Mr. Collins also supplies a 10 guinea Wenham Binocular, with Objectives of 1 inch and 1-4th inch ( $80^\circ$ ), the latter being specially adapted for use with the Binocular, by a short mount which brings it close to the Wenham prism.—Mr. Swift makes

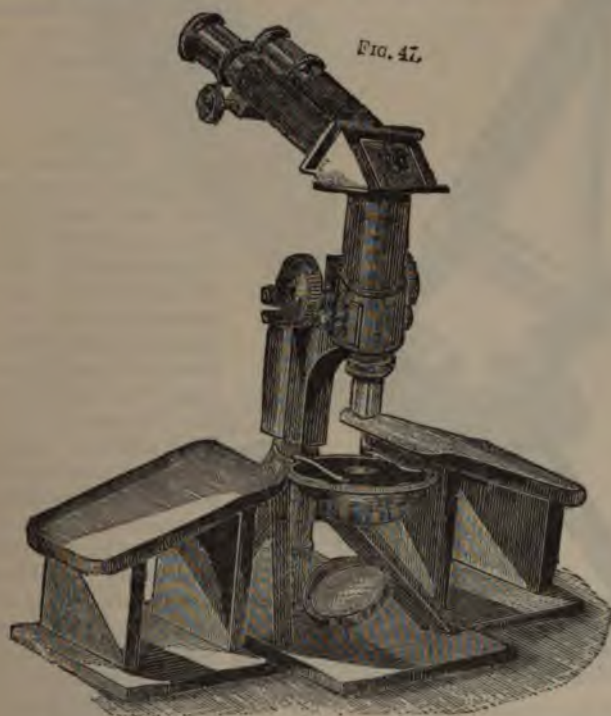

Baker's Student's Erecting Binocular.

a 'College' Microscope, in which the Stage is fitted with a revolving diaphragm-plate of ingenious construction, that brings its apertures up to the level of the object-slide. Of Mr. Crouch's and Messrs. Parkes's Students' Microscopes also, the Author can speak with approval, as regards both the mechanical and the optical part of their work.

65. *Second-Class Microscopes.*—Under this head may be ranked those instruments which combine first-rate workmanship with simplicity in the plan of construction; and which may be consequently designated as 'Superior Students' Microscopes.' Among these the first place should be given to Messrs. Powell and Lealand's *Smaller Microscope* (Fig. 48), which was long the favorite instrument of British Histologists, and which, though not adapted for objects requiring very oblique light, is still in demand



among those who value first-rate workmanship, with all convenient appliances for ordinary Biological research. A Sub-stage (not shown in the figure) carrying every kind of illuminating apparatus, can be attached beneath the stage; and the large angular aperture now given by Messrs. Powell and Lealand to their Immersion Achromatic Condenser, enables this instrument to resolve the most difficult test-objects. The stand is

FIG. 42.

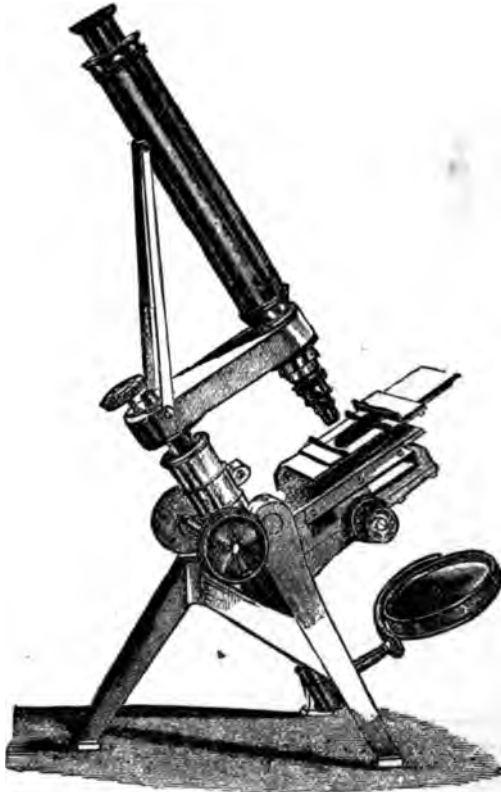

Powell and Lealand's Smaller Microscope.

well suited to carry a Binocular body; which may be fitted not only with the ordinary stereoscopic 'Wenham' prism, but also with the non-stereoscopic arrangement of these Makers (§ 81), which enables even the highest powers to be used binocularly, though not stereoscopically.

66. The value of Stereoscopic Binocular vision in Scientific investigation being now admitted by all who have really worked with it upon suitable objects, the Author would earnestly recommend every one about to provide himself with even a Second-class Microscope, to incur the small expense of the Binocular addition. This addition, however, will lose an important element of its value, if the Stage of the instrument be not adapted to rotate in the optic axis of the Body; so that objects which are being viewed by incident light may be presented to the illuminating rays in every direction.

Among the first to recognize this principle, and to apply it in practice, were Messrs. Beck; whose *Popular Microscope* (Plate IV.), devised by the late Mr. R. Beck, will be found very suitable to the wants of such work with low and moderate powers upon objects for the study of which Binocular vision is peculiarly advantageous; and especially serviceable to Travellers, as the ingenious way in which it is framed and supported enables it to bear a good deal of rough usage without injury. The original Ross model here adopted in the support and movement of the body, is sufficiently steady when only moderate powers are employed; and the stem that forms the centre of the whole, is swung immediately behind the stage on a broad stay G, which, again, is attached by a pair of centres at its lower angles to the triangular base F. The lower end H of the stem carries a stout projecting pin, which fits into various holes along the median line of the base; whereby the instru-

PLATE IV.



BECK'S POPULAR MICROSCOPE.

searched in positions more or less inclined, or may be fixed in the horizontal position required for the Camera Lucida; for the pin at the bottom of the hole at the top of the stud *K*, and the stay *G* falls on the top of the stout pin *L*. The advantages of this is that it is strong, firm, and yet light; that the instrument is at the particular inclination desired, which is often not possible in the ordinary construction when the joint has worked in every position there is the needful preponderance of weight; the plate is circular, and upon it fits a circular plate *T*, the optic axis of the Microscope. On the plate *T* there is an object-holder *V*, which is so attached to it by a wire spring *W* on its under surface, as to be easily moved by either or the other hands; as access can be readily gained to this spring by detaching the stage, it may either be removed altogether so as to be free, or may be adjusted to any degree of stiffness or pressure. The object-holder has a ledge *V* for the support of the slide, and it is also provided with a small spring *W*, attached to it by a milled-head, by turning which the spring may be brought to bear with any required pressure against the edge of the slide laid upon the object-holder, so as to prevent it from shifting its place when rotation is given to the stage, or when, the instrument being placed in the horizontal position, the stage becomes vertical. The central tube of the Stage is furnished with a rotating Diaphragm-plate, and is adapted to receive various other fittings; and a Side-Condenser on a separate stand is also supplied.<sup>1</sup>

FIG. 49.



Collins's Harley Binocular.

67. *Collins's Harley Binocular*.—This instrument, as represented in Fig. 49, is substantially framed and well hung on the Ross model; but is now made also on the Jackson model at the same price. The caps of the Eye-pieces are provided with shades, which cut off the outside lights from each eye; these can be adapted to any instrument, and the Author can speak strongly of their value from his own ex-

<sup>1</sup> The price of this instrument, with two pairs of Eye-pieces, three Objectives (of 10°, a 1-inch of 22°, and a 1-4th of 75°), and Side-Condenser on stand, is £16 10s.

perience. The Wenham prism at the common base of the bodies is fitted into an oblong box, which slides through the arm that carries them; this contains, in addition, a Nicol analyzing prism, and is also pierced with a vacant aperture; so that, by merely sliding this box transversely until its aperture comes into the axis, the instrument may be used as an ordinary Monocular; or, if the analyzing prism be made to take the place of the Wenham, whilst the polarizing prism beneath the stage is brought into position by rotating the Diaphragm-plate in which it is fixed, it is at once converted into a Polarizing Microscope—with the disadvantage, however, of not being then Binocular. It has also a 'nose-piece' carrying two Objectives, by a sliding movement of which one power may be substituted for the other.<sup>1</sup>

68. *Swift's Challenge Microscope*.—The instrument constructed under this designation by Messrs. Swift, is one of which it may be fairly said that it is surpassed by no other of its price in the excellence of its workmanship, and its suitability to the general wants of the Microscopist. The support on which it is hung is extremely firm and substantial without being heavy; and when the limb is brought to the horizontal position, resting on the cross plate between the two uprights, the instrument is still well balanced. The rack and pinion movement is made with oblique teeth; a construction which favors smoothness and sensitiveness in the adjustment, so that a 1-4th inch objective may be focussed by it alone. The fine adjustment is made by the milled-head at the lower end of the body.—It is a peculiarity in this instrument, which especially fits it for those who work much with Polarized light, that the analyzing prism is fitted

into the body above the Wenham prism, in such a manner that, when its fitting is drawn out (without being removed), it is completely out of the way of the light-rays; whilst, when the use of the Polariscope is required, the prism can be at once pushed into the body, working in conjunction with the Wenham prism. This mode of mounting the analyzer is found to interfere much less with the definition of the objective, than the insertion of it between the objective and the Wenham

FIG. 50.



Swift's Challenge Microscope.

<sup>1</sup> The price of this instrument, with Mechanical rotating Stage, two pairs of Eye-pieces, two Objectives (either a 2-inch of 12", or a 1-inch of 18", with a 1-4th of 95"), Side-Condenser on Stand, and Polarizing apparatus in Cabinet, is £19. Accessories of various kinds can be readily fitted to it.—A 'first-class' Binocular is also constructed by the same Maker on the Jackson model.



prism. The stage rotates in the optic axis; and may either bear (as in the figure) a sliding object-carrier, or may be furnished with mechanical actions. The mirror is attached to the stem by a crank-arm, allowing it to be so placed as to reflect light of considerable obliquity. Beneath the Stage is a broad horizontal dovetail groove, into which is very exactly fitted a firm (sprung) slide that carries a Sub-stage for illuminating apparatus, fitted with a vertical rack movement, and with horizontal centering screws; this arrangement (devised by Mr. Swift) enables the sub-

FIG. 51

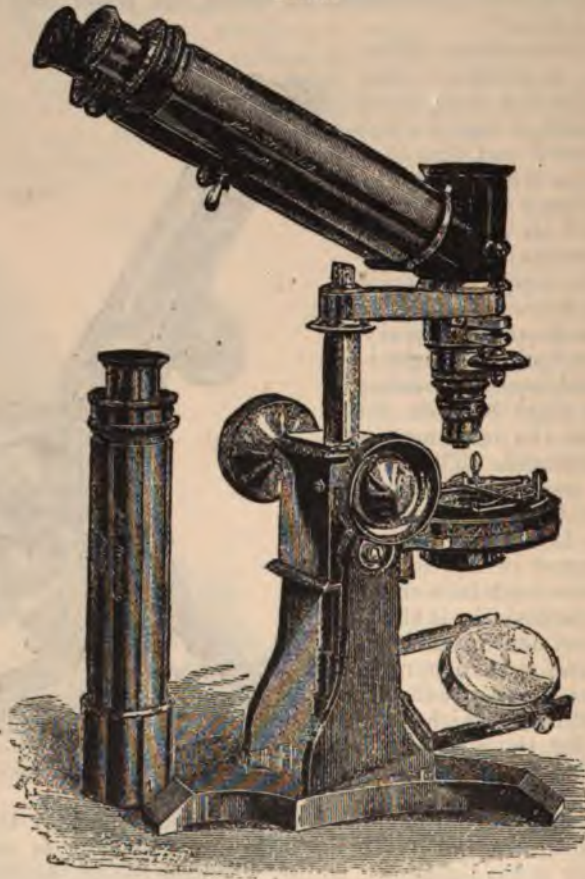

Browning's Smaller Stephenson Binocular.

stage to be placed in position or removed, without disturbing either the stage or the mirror. The extremely ingenious Universal Sub-stage—combining Achromatic Condenser, Black-ground Illuminator, and Polarizer with varied adaptations—devised by Mr. Swift for this Microscope, but capable of being applied to any other, will be described hereafter (§ 112). The Author, having had his instrument (thus fitted) in constant

use for several years past, feels justified in unreservedly expressing his high appreciation of it.<sup>1</sup>

69. *Browning's Smaller Stephenson Binocular.*—This instrument, represented in Fig. 51, is of more substantial build than the Students' Binocular of Messrs. Baker (§ 64); and is further distinguished by its special adaptation for use with Polarized light. In place of the reflecting prism at the junction of the inclined bodies, a plane piece of dark glass, silvered on one face, is hung on a horizontal axis at the polarizing angle; its silvered face being turned in front when it is used for ordinary purposes, so as to reflect into the two inclined bodies, the light-rays which proceed to it from the pair of dividing prisms; whilst, when it is to act as an analyzer, it is turned on its axis by means of a milled-head so as to bring the dark-glass surface to the front. Further, by fixing into the arm the tube which carries the objective, with its fine adjustment, and by making that which contains the dividing prisms and mirror, and which also carries the double body, slide over it, the latter can either be turned half round, so as to point the eye-pieces in the reverse direction (for the exhibition of the object to an observer sitting at the opposite side of a small table) without any disturbance of the adjustments; or it can be lifted off altogether, and replaced by an ordinary Monocular body.<sup>2</sup>

#### FIRST-CLASS MICROSCOPES.

70. We now pass to an entirely different class of Instruments—those of which the aim is, not simplicity, but perfection; not the production of the best effect compatible with limited means, but the attainment of everything that the Microscope *can* accomplish, without regard to cost or complexity. To such, of course, the Stereoscopic Binocular is an indispensable addition; and it is not less essential that the Stage should have a *rotatory movement in the Optic axis of the instrument*;—not only for the due examination of *opaque* objects, as already mentioned (§ 66), but also because this movement is requisite for the effective examination of very delicate *transparent* objects by Oblique light, allowing the effect of light and shadow to be seen in every direction; and, in addition, because in the examination of objects under Polarized light, a class of appearances is produced by the rotation of the object between the prisms, which is not developed by the rotation of either of the prisms themselves.

71. *Ross's First-class Microscope.*—As what is known as the *Ross* model is still made, being preferred by some purchasers, we shall commence with a notice of the original form of the instrument which has gained so high a celebrity.—The general plan of this Microscope, as shown in Fig. 52, is carried out with the greatest attention to solidity of construction, in those parts especially which are most liable to tremor,

<sup>1</sup> The price of this instrument in the simple form here figured, with one pair of Eye-pieces and best 1-inch and 1-4th inch (80°) Objectives, and Condensing lens on separate stand, in Case, is £14. A mechanical stage costs £3 10s. additional, and the sub-stage (without fittings) £3 2s.—A very ingenious 'swinging sub-stage' has been lately devised by Mr. Swift ("Journ. of Roy. Microsc. Soc.," vol. iii., 1890, p. 867) for obtaining illumination of any degree of obliquity, even by two pencils at once. The Condenser is made to slide on an arc-piece (as in Mr. Grubb's arrangement, § 72), which is prolonged above the Stage for opaque illumination; and with this may be combined a second arc-piece at right angles to the first, carrying a second Condenser, which is found serviceable in the resolution of difficult Diatom-tests.

<sup>2</sup> The price of this instrument, with one pair of Eye-pieces and Objectives of 1 inch (16°) and 1-4th inch (75°), is £30. Any Accessories can readily be added to it.

AS ALSO TO THE USE OF THE BALANCING OF THE WEIGHT OF ITS DIFFERENT PARTS UPON THE HORIZONTAL AXIS. THE BALANCE MAY BE GIVEN TO IT, AND IT MAY BE FIXED IN ANY POSITION OF A TRAVELING SCREW, TURNED BY A SHORT LEVER ON THE RIGHT-HAND SIDE. THE BALANCE IS EFFECTED BY THE MILLED-HEAD OF THE TRAVELING ARM, WHICH AT THE BASE OF THE SCREW HAS AN AXIS UPON THE RIGHT-HAND SIDE, WHICH MOVES THE ARM, WHEREIN THE OBJECTIVES ARE MOUNTED. THE OTHER MILLED-HEAD, SEEN AT THE SUMMIT OF THE STEM, SERVES

FIG. 32



ROSS'S CLASS MICROSCOPE.

TO SECURE THE TRANSVERSE ARM TO THIS, AND MAY BE TIGHTENED OR SLACKENED AT PLEASURE, SO AS TO REGULATE THE TRAVELING MOVEMENT OF THE ARM; THIS MOVEMENT IS ONLY ALLOWED TO TAKE PLACE IN ONE DIRECTION, NAMELY, TOWARDS THE RIGHT SIDE, BEING CHECKED IN THE OPPOSITE BY A "STOP," WHICH SECURES THE COINCIDENCE OF THE AXIS OF THE PRINCIPAL "BODY" WITH THE CENTRE OF THE STAGE, AND WITH THE AXIS OF THE ILLUMINATING APPARATUS BENEATH IT. THE OBJECT-PLATE, TO WHICH RECTANGULAR TRAVELING MOTIONS ARE GIVEN BY THE TWO MILLED-HEADS AT THE RIGHT OF THE STAGE, IS ALSO MADE TO ROTATE IN THE OPPOSITE DIRECTION BY A MILLED-HEAD PLACED UNDERNEATH THE STAGE ON THE LEFT-HAND SIDE; THIS TURNS A PINION WHICH WORKS AGAINST A CIRCULAR RACK, WHEREBY THE WHOLE APPARATUS ABOVE IS CARRIED ROUND ABOUT TWO-THIRDS OF A REVOLUTION, WITHOUT IN THE LEAST DISTURBING THE PLACE OF THE OBJECT, OR REMOVING IT FROM THE FIELD OF THE MICROSCOPE. THE GRADUATION OF

THE SCREW WORK, HOWEVER, CAN BE USED AS A GONIOMETER (§ 92). BELOW THE STAGE, AND IN FRONT OF THE STEM, IS CARRIED THE MIRROR, IS A TRAVELING SLIDING BAR, WHICH IS MOVED BY A SCREW TURNED BY THE MILLED-HEAD ON THE RIGHT SIDE. THIS SLIDING BAR IS WHAT IS CALLED BY MR. ROSS THE "CONDENSING STAGE," WHICH CONSISTS OF A TUBE FOR THE RECEPTION OF THE ANIMAL CONDENSER, FLUORITE PRISMS, AND OTHER APPARATUS. TO THIS SECONDARY STAGE A TRAVELING MOVEMENT OF LIMITED EXTENT IS GIVEN BY MEANS OF TWO SCREWS, ONE ON THE FRONT AND THE OTHER ON THE LEFT-HAND SIDE OF THE STAGE, WHICH CARRIES IT IN SUCH A MANNER THAT ITS AXIS MAY BE BROUGHT INTO PERFECT COINCIDENCE WITH THE AXIS OF THE BODY; AND A ROTATORY MOVEMENT ALSO IS GIVEN TO THIS SECONDARY STAGE BY A MILLED-HEAD, WHICH IS ESPECIALLY USEFUL, AND THE EXTENT OF WHICH IS MEASURED BY A GRADUATED SCALE. THE SEVERAL ADVANTAGES OF THIS INSTRUMENT CONSIST IN



its general steadiness, in the admirable finish of its workmanship, and in the variety of movements which may be given both to the object and to the fittings of the secondary or sub-stage. Its disadvantages consist in the want of portability that necessarily arises from the substantial mode of its construction; and in the liability to tremor in the image, when the highest powers are used, through the want of support to the body along its length (§ 49).—This last consideration has induced Messrs. Ross to adopt the 'Jackson-model' in their more recent Microscopes; the newest and most complete form of which will be next described.

72. *Ross's Improved Jackson-Zentmayer Microscope.*—In this admirable instrument (Plate v.) the Jackson-model is followed as to general construction, whilst it is improved-on in various important particulars. The 'limb' that supports the principal body with the usual rack-and-pinion slide for coarse adjustment, carries also a second (or focussing) slide at the back of the first, to which a slow up-and-down movement is given by a lever passing through a channel in the limb, which is acted-on by a micrometer-screw with a large milled-head placed in a very accessible position. This arrangement renders the fine adjustment quite free from either 'twist' or 'loss of time,' whilst permitting it to work with sufficient freedom; and has the advantage of not affecting the magnifying power by altering the length of the body. Further, if a divided scale (with a vernier) be engraved on the edge of the limb, the thickness of any uncovered object lying on the stage can be measured with great exactness. The rotating stage-plate (graduated at its edge to serve as a Goniometer), is supported upon a firm ring composed of metal of peculiar inflexibility; and to this it can be secured in any azimuth by a clamping-screw beneath. Its single traversing platform is moved in rectangular directions by two milled-heads placed on the same axis, that work-a combination of screw and pinion (devised by the ingenuity of Mr. Wenham), which is placed above instead of beneath it; and in this device more oblique light (it is affirmed) can be brought to bear upon the lower surface of the object, than in any other mechanical stage yet constructed. The stage-ring is not immovably fixed to the limb, but is attached to a conical stem, which passes through the tubular pivot of the swinging 'tail-piece' to be presently described, and is clamped at the back of the instrument by a strong screw and nut. Thus the stage may be made to incline toward either side at any angle, so that a view may be gained of the sides and edges of a solid object, as well as of its front; or it may be removed altogether, and replaced by any other form of object-support more suitable to the special requirements of the individual Microscopist.—The most important novelty, however, consists in the adoption of the (patented) Zentmayer method of giving to the entire illuminating apparatus any desired degree of obliquity. The 'idea' is by no means new; and it was carried-out many years ago by the late Mr. Grubb of Dublin, who fixed beneath the stage a sector or arc-piece of nearly a semi-circle having its centre in the object, upon which the attachments of the mirror and condenser were made to slide. But the arrangement devised by Mr. Zentmayer is not only far simpler, but also more effective. It consists in swinging the 'tail-piece' which carries the mirror and the secondary or sub-stage, upon a pivot placed at the back of the stage, the horizontal axis of which is in a line with the point of intersection of the optic axis of the body with the plane of the object on the stage; so that the axis of the condenser shall always pass through that point, whatever may be its inclination to the perpendicular. By



PLATE V.

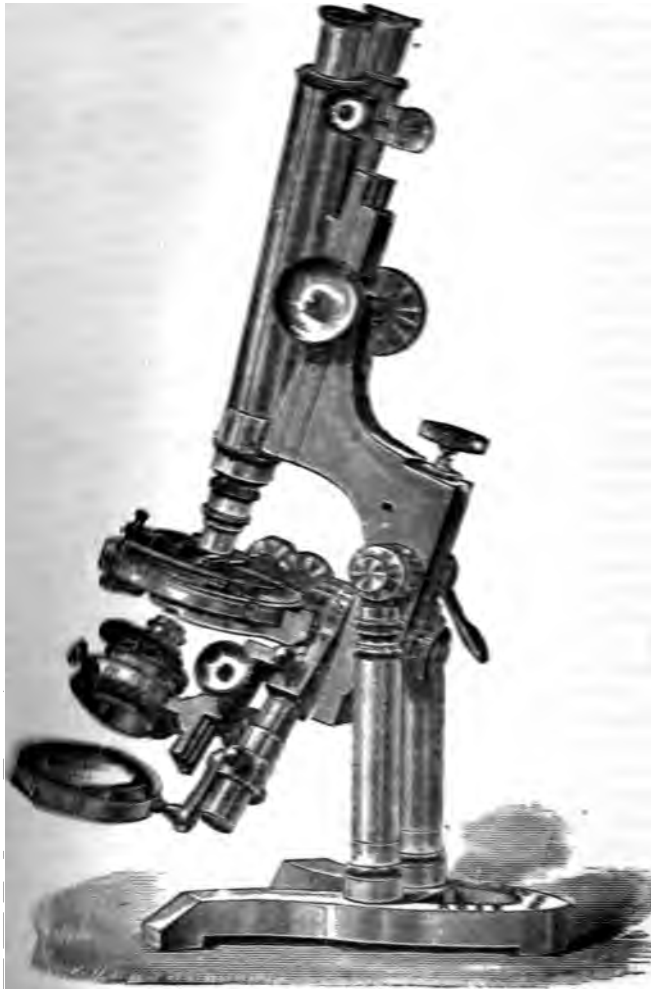

NO. 1. IMPROVED ZEISS-ZENTRALES MICROSCOPE.

means of this arrangement, every kind of illuminating apparatus adapted to the sub-stage can be made to act at any obliquity whatever; and as the tail-piece may be swung round on the side opposite to that of the milled-heads of the traversing stage, until it is brought considerably *above* the stage, oblique illumination may be thrown by the condenser, not only on the under but also on the *upper* surface of any object. It is one great advantage of this method, that condensers of large angle of aperture are not required for the purpose of oblique illumination; the converging pencils given by ordinary Objectives of 1 inch or  $1\frac{1}{4}$  inch focus, used as condensers, being fully adequate. Further, the swinging tail-piece may be used to measure the angular aperture of Objectives in the manner to be hereafter described, its inclination to the optic axis being marked by a divided arc on its upper segment, which also enables the illuminating angle at which any particular object is best seen to be observed and recorded.—Altogether, it may be unhesitatingly affirmed, that the Zentmayer system enables the best results of oblique illumination to be obtained with greater facility than any other of equal effectiveness; while the simplicity of the construction of the whole instrument enables Messrs. Ross to reduce its cost considerably below that of the old Ross or Ross-Jackson models.

73. *Powell and Leland's Large Microscope.*—These eminent Makers have not made any essential modification in the construction of their large Microscope, represented in Plate VII.; preferring to furnish the very oblique illumination now in general demand by enlarging the angular aperture of their Achromatic Condenser (§ 99). The chief peculiarity of their model consists in the attachment both of the Stage and Sub-stage to a large solid brass ring, which is firmly secured to the stem of the instrument. The upper side of this ring bears a sort of carriage that supports the stage; and to this carriage a rotatory movement around the optic axis of the principal body is given by a milled-head, the amount of this movement (which may be carried through an entire revolution) being exactly measured by a graduated circle. The stage, which is furnished with the usual traversing movements, worked by two milled-heads on the same axis, is made thin enough to admit of the mirror being so placed, by means of its extending arm, as to reflect light on the object from outside the large brass ring that supports the stage and sub-stage. Light of the greatest obliquity, however, may be more conveniently obtained by an Amici's prism (§ 102) placed above the supporting ring. The sub-stage is furnished with rotatory and rectangular, as well as with vertical movements. The instrument is so well balanced on its horizontal axis, that it remains perfectly steady without clamping, in whatever position it may be placed.

74. *Beck's First-class Microscope.*—It was by this Firm that the Jackson model was first adopted, for which the Author has already expressed his preference (§ 49). Besides the steadiness imparted to the double body by the support given to it by the limb along the greater part of its length, it is an additional advantage of this construction, that by continuing the limb beneath the stage, the secondary body or Sub-stage (which carries the illuminating apparatus) is made to work in a dovetailed groove that is ploughed-out in continuity with that in which the rack of the principal body slides, an arrangement obviously favorable to exactness of centering. The Stage has a nearly complete rotation in the optic axis of the instrument, motion being given to it by a milled-head beneath the stage, the pinion attached to which can be readily

PLATE VI.

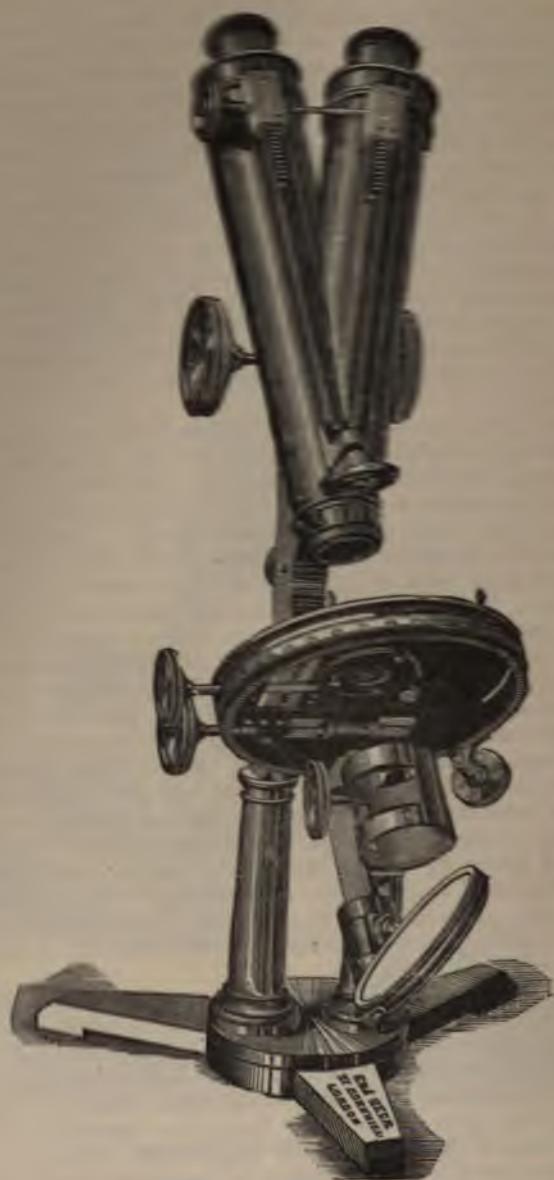

MESSRS. DECK'S LARGE MICROSCOPE.

PLATE VII.

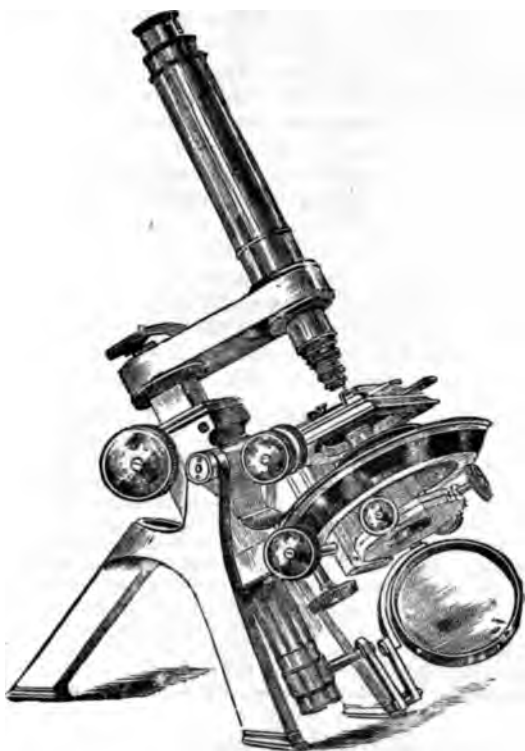

POWELL AND LEALAND'S LARGE MICROSCOPE.



thrown out of gear when a more rapid rotation of the stage by hand is desired; and it bears a graduated circle at its margin for the measurement of angles. It is fitted immediately beneath the object-platform with an iris-diaphragm, worked by a lever action.

75. *Beck's Improved First-class Microscope.*—In order to meet the demand for very oblique illumination, and to supply this in a mode yet more perfect than the Zentmayer system, Messrs. Beck have adapted to the preceding instrument a swinging sub-stage, carried by an arm that works radially upon a large vertical disk attached to the limb, on the plan originally suggested by Mr. Grubb; his semi-circle being extended, however, into a nearly complete circle, so as to allow the arm carrying the sub-stage and mirror to be brought round to the upper side of the stage, for the illumination of opaque objects. The essential feature of their construction, however, which differentiates it from every other yet devised, consists in a provision for adjusting the illuminating apparatus to the thickness of the glass slide on which the object is mounted. This is effected by making the disk with its radial arm, slide vertically in a dove-tail fitting; the illuminating apparatus attached to it, at whatever degree of obliquity it may be placed, being raised or lowered (by a lever-handle) in the optical axis of the instrument, so as to enable the illuminating cone to be exactly focussed in the object itself—which on the Zentmayer model, can only be done with precision when the upper surface of the slide is exactly in the plane of the horizontal axis of the swinging 'tail-piece.'—The Stage also, in this elaborate instrument, is so attached to the limb by a firm pivot, as to be capable not only of being inclined toward either side at any angle, but also of being turned completely over, so as to allow the object to be viewed from its under side—a provision to which the Author's experience makes him attach a special value.

First-class Binocular Microscope-Stands, copied (more or less closely) from either the Ross or the Jackson models, are also made by Messrs. Baker, Collins, Crouch, Pillischer, and Swift, as well as by other makers of whose work the Author has no personal knowledge.—That of Mr. Crouch is distinguished by a provision for meeting the difficulty which is continually experienced, of keeping the image in place during the rotation of the stage, especially with high powers; the adjustment which suits one Objective, not being good for another somewhat differently centered. This defect presents itself still more frequently when a 'nose-piece' is in use; its centering being rarely so exact as to be free from an error that makes itself very perceptible when a high power is exchanged for a low one. By means of two diagonal screws beneath the stage, worked by two milled-heads at its hinder margin, Mr. Crouch affords a ready means by which the observer can adapt the centering of his stage to any objective he may have in use.—Mr. Browning also constructs a First-class Stand for his Stephenson Binocular.

#### MICROSCOPES FOR SPECIAL PURPOSES.

Of the large number of instruments which have been ingeniously devised, each for some particular use, it would be quite foreign to the purpose of this Treatise to attempt to give an account. A few forms, however, may be noticed, as distinguished either by their special adaptiveness to very common wants, or by the ingenious manner in which the requirements of particular classes of investigators have been met.

76. *Dr. Beale's Pocket Microscope.*—This instrument consists of an ordinary Microscope-body, the Eye-piece of which is fitted with a draw-tube that slides smoothly and easily; whilst its lower end is fitted into an outer tube, of which the end projects beyond the objective. Against this projecting end the object-slide is held by a spring, as shown in Fig. 53,

being fixed (if necessary) by a screw-clip. The coarse adjustment is made by sliding the body through the outer tube which carries the object; and the fine adjustment by sliding the eye-tube in or out. The object, if transparent, is illuminated either by holding up the Microscope to a window or lamp, from which the rays may pass directly through it, or by directing it towards a mirror laid on the table at such an angle as to reflect light from either of these sources: if opaque, it is allowed to receive direct light through an aperture in the outer tube. The extreme simplicity and portability of this instrument (which when closed is only six inches long) constitutes its special recommendation. With due care even high powers may be used, the eye-piece adjustment giving the power of very exact focussing. Hence this Pocket Microscope may be conveniently applied to the purposes of Clinical observation (the examination of Urinary Deposits, Blood, Sputa, etc.), either in hospital or in private practice; whilst it may also be advantageously used by the Field Naturalist in examining specimens of Water for Animalcules, Protophytes, etc.

FIG. 53.

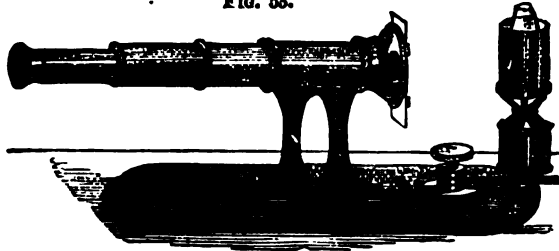

Dr. Beale's Demonstrating Microscope.

77. *Dr. Beale's Demonstrating Microscope.*—The same instrument may be used for the purposes of Class-demonstration, by attaching its outer tube on a wooden support to a horizontal board, which also carries a small lamp attached to it in the required position (Fig. 53). The object having been fixed in its place, and the coarse adjustment made by sliding the body in the outer tube, these parts may then be immovably secured, nothing being left movable except the eye-tube, by sliding which in or out the fine adjustment may be effected. Thus the whole apparatus may be passed from hand to hand with the greatest facility, and without any probability of disarrangement; and every observer may readily 'focus' for himself, without any risk of injuring the object.<sup>1</sup>

78. *Baker's Travelling Microscope.*—An instrument has been devised by Mr. Moginie, which is but little inferior in portability to the Pocket Microscope of Prof. Beale, and has some advantages over it. The body (Fig. 54) slides in a tube which is attached to a stem that carries at its end a small Stage and Mirror. The stem itself contains a fine adjustment that is worked by a milled-head at its summit; and near to this is attached by pivot-joint a pair of legs, which, when opened-out, form with the stem a firm tripod support. The coarse adjustment having been made by sliding the body through the tube which grasps it, the fine adjustment is

<sup>1</sup> The price of Dr. Beale's Clinical Microscope, as made by Mr. Collins, without Objectives, is £1 11s. 6d. That of the same instrument fitted up as a Demonstrating Microscope, is £3 3s.—Mr. Collins also makes another Class and Demonstration Microscope, or a pattern of Dr. Lawson's for £3 10s., without Objectives.

made by the milled-head; and thus even high powers may be very conveniently worked. The legs being tubular, one of them is made to hold glass dipping-tubes, whilst the other contains needles set in handles, with three short legs of steel wire, by screwing which into the stem and stage, the Microscope may be used (though not without risk of overturn) in the

vertical position. This instrument may be specially recommended to those who, already possessing a superior Microscope, desire neither to encumber themselves with it whilst travelling, nor to expose it to risk of injury, but wish to utilize its Objectives by means of a simple and portable arrangement.<sup>1</sup>

79. *Swift's Portable Binocular*.—Carrying still further an idea originally worked-out by Messrs. Powell and Lealand, Mr. Swift has devised a very complete Portable Binocular, which can be *folded* into a very small compass, without any screwing or unscrewing, and can be thus set up, as in Fig. 55 A, or packed away, as at Fig. 55 B, with great facility, when once the manner of doing so has been learned. Its construction is a

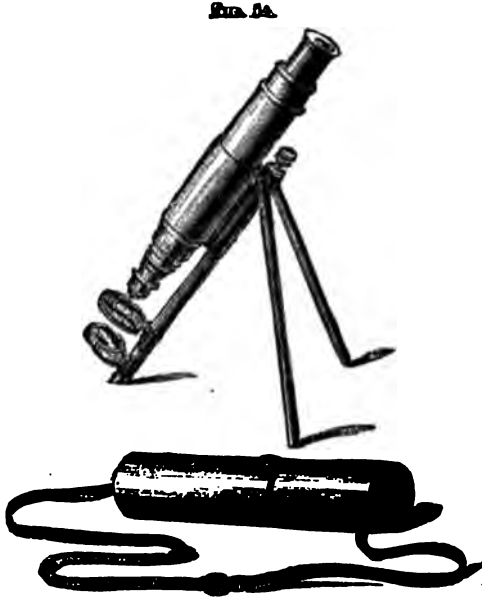

Baker's Travelling Microscope.

marvel of ingenuity; while its workmanship is so excellent that its joints do not easily become loosened by wear, and can all be readily tightened when required. It is so steady as to bear being worked (as a Monocular) with even high powers; but its great advantage consists in its suitability to the Traveller, who either wishes (as often happens to the Author) to display to scientific friends in other countries a set of objects that can be most advantageously seen by the Binocular under low powers, or to avail himself of opportunities of examining on the spot any interesting specimens he may meet with. The instrument also carries Mr. Swift's Combination Sub-stage (Fig. 85), which can be packed, together with three Objectives, Side-Condenser, and several other Accessories, into a Case only 11 inches long, 6½ inches wide, and 3½ inches deep, the whole weighing only 7½ lbs.

80. *Nachet's Chemical Microscope*.—The inverted Microscope originally constructed by M.M. Nachet on the plan devised by Dr. J. Lawrence Smith, of Louisiana, U.S., for the purpose of viewing objects from their *under* side when heat or re-agents are being applied to them,<sup>2</sup> has lately been improved by its constructor with a special view to meeting the requirements of observers engaged in the 'cultivation' of the minute organ-

<sup>1</sup>Instruments nearly resembling the above are made by Messrs. Murray and Heath, Mr. Browning, and Mr. Swift.

<sup>2</sup>This idea was suggested at nearly the same time by Dr. Leeson; and was carried out in an instrument constructed for him by Messrs. Smith and Beck.



isms which act as ferments. The general arrangement of this instrument is shown in Fig. 56. On the table which forms its base, there rests a box containing a glass mirror silvered on its upper surface, which is placed at such an angle as to reflect the light-rays received through the inverted Objective mounted on the top of the box, into the body fixed into its oblique face. Over the objective is placed the Stage, above which again is the Mirror for reflecting light downwards through the object placed upon it. The focal adjustment is made in the first place by means of a sliding tube which carries the objective, and then by the micrometer-screw *v*, which raises or lowers the stage. The platform on which the optical apparatus rests, can be moved in rectangular directions by the two milled-heads, *o*, *t*; and is furnished with two graduated scales, by means of which it may be brought with exactness into any position previously recorded, so that any point of the object may be immediately re-found—an arrangement of special value in cultivation-experiments. On the stage is a circular glass cell, *c*, for holding the fluid to be examined; in the bottom of this is an aperture, which is closed by a piece of thin cover-glass well cemented round its edges, thus allowing the use of high magnifying powers hav-

FIG. 55 A.



Swift's Portable Binocular, as set up for use.

FIG. 55 B.



Swift's Portable Binocular, as packed in case.



ing a short very focus; while its top is ground flat, so that a cover of thin plate-glass may be closely fitted to it by the intervention of a little grease or glycerine; the whole being secured in its place by three small uprights. The cell is furnished also with two small glass taps, R, R, with which india-rubber tubes are connected. By this cell, which may be made to serve as a moist, a warm, and a gas-chamber, experi-

FIG. 56.



Nacet's Chemical Microscope.

ments on the rarefaction and compression of air, and on the absorption of gases, can be made with great facility. For 'cultivation' experiments, smaller cells are provided, which are attached to brass-plates so arranged as to have always a fixed position on the stage.<sup>1</sup>

81. *Non-Stereoscopic Binoculars.*—The great comfort which is experienced by the Microscopist from the conjoint use of both eyes, has led to the invention of more than one arrangement by which this comfort can be secured, when those high powers are required which cannot be employed with the ordinary Stereoscopic Binocular. This is accomplished by Messrs. Powell and Lealand by taking advantage of the fact already adverted to (§ 1), that when a pencil of rays falls obliquely upon the surface of a refracting medium, a part of it is reflected without entering that medium at all. In the place usually occupied by the Wenham prism, they interposed an inclined plate of glass with parallel sides, through which one portion of the rays proceeding upwards from the whole aperture of the Objective passes into the *principal* body with very little change in its course, whilst another portion is reflected from its surface into a rectangular prism so placed as to direct it obliquely upwards into the *secondary* body (Fig. 57). Although there is a decided difference in brightness between the two images, that formed by the reflected rays being the fainter, yet there is marvellously little loss of definition in either, even when the 25th-inch objective is used. The disc and prism are fixed in a short tube, which can be readily substituted in any ordinary Binocular Microscope for the one containing the Wenham prism. — Other arrange-

<sup>1</sup> A *Mineralogical Microscope* specially contrived by M. Nacet for minute Petrological researches, will be described at the end of Chap. XXI.

ments were long since devised by Mr. Wenham,<sup>1</sup> with a view to obtain a greater equality in the amount of light-rays forming the two pictures; and he has lately carried one of these into practical effect, with the advantage that the compound prism of which it consists, has so nearly the same shape and size as his ordinary stereoscopic prism, as to be capable of being mounted in precisely the same manner, so that the one may be readily exchanged for the other. The axial ray  $a$ , proceeding upwards from the objective, enters the prism  $A B D E F$  (Fig. 58) at right angles to its lower face, and passes on to  $c$ , where it meets the inclined face  $A B$ , at which this prism is nearly in contact with the oblique face of the right-angled prism  $A B C$ . By internal reflection from the former, and external reflection from the latter,

about half the beam  $b$  is reflected within the first prism in the direction  $c b$ , while the other half proceeds straight onwards through the second prism, in the direction  $c a'$ , so as to pass into the *principal* body. The reflected half, meeting at  $d$  the oblique (silvered) surface  $D E$ , of the first prism, is again reflected in the direction  $d b'$ ; and passing out of that prism perpendicu-

FIG. 57.

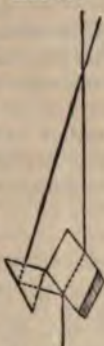
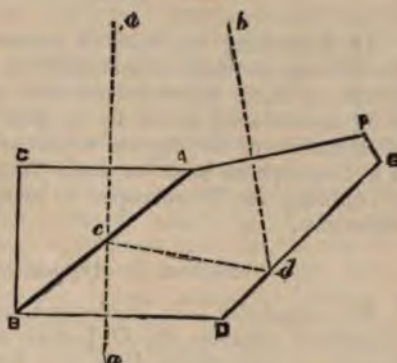

FIG. 58



ly to its surface  $A F$ , proceeds towards the *second-ary* body. The two prisms must not be in absolute

Powell and Lea-land's Non-Stereoscopic Binocular Arrangement.

contact along the plane  $A B$ , since, if they were, Newton's rings would be formed; and much nicety is required in their adjustment, so that the two reflections may be combined without any blurring of the image in the secondary body. Being (by Mr. Wenham's kindness) the possessor of a prism thus adjusted by himself, the Author can bear testimony to the excellence of its performance; and he feels sure that for the prolonged observation, under high powers, of objects not requiring the *extreme* of perfection in definition—such, for example, as the study of the Cyclosis in Plants,—great advantage is gained from the conjoint use of *both* eyes by one of the above arrangements.

<sup>1</sup> "Transactions of the Microsc. Soc." N.S., Vol. xiv. (1866), p. 105.

## CHAPTER III.

## ACCESSORY APPARATUS.

IN describing the various pieces of Accessory Apparatus with which the Microscope may be furnished, it will be convenient in the first place to treat of those which form (when in use) part of the instrument itself, being appendages either to its Body or to its Stage, or serving for the Illumination of the objects which are under examination; and secondly, to notice such as have for their function to facilitate that examination, by enabling the Microscopist to bring the objects conveniently under his inspection.

Section 1. *Appendages to the Microscope.*

82. *Amplifier.*—It is obvious that if, by the use of a concave lens interposed between the Objective and the Eye-piece, the divergence of the rays, in the course from the former to the latter, be increased, the magnifying power of the instrument will be augmented in proportion; and such an addition (which was long since introduced into Telescopes, and also into the Solar Microscope) has been brought into general use in the United States, having been first made effective by Mr. Tolles. As constructed by him, the Amplifier is an achromatic concavo-convex lens of small diameter, screwed into the lower end of the draw-tube, so as to be at no great distance behind the objective, the power of which it doubles, without (it is affirmed) producing sensible deterioration of the image. Dr. Devron, of New Orleans, states that two photographs having been taken of *Amphiptera pellucida*, the one by a Tolles' 1-12th with amplifier, the other with a Tolles' 1-25 without amplifier, they proved to be scarcely distinguishable; and that the 19th band of Nobert's ruled plate could be resolved with its aid, by objectives under which without it no resolution could be obtained.<sup>1</sup> It is obvious that if the magnifying power of our Microscopes can be thus doubled, without the strain of eyes, and the loss of light and of definition, produced by deep Eye-piecing, and without the necessity of employing Objectives of inconveniently short focus and great cost, a great advantage will have been gained; while those who wish to possess a graduated range of powers, need only supply themselves with half the number of Objectives needed to give it, since each can be made to do double work (a 1 inch, for example, serving also as a half-inch) without change either of the eye-piece or the focal adjustment.—Dr. Wythe, of San Francisco, states that he has obtained very good results by placing a double-concave or a concavo-convex lens of about 6 inches focus, and of as large a diameter as the tube will allow, about 3 inches below the

<sup>1</sup> "American Monthly Journal of Microscopy," Vol. iii. (1878), p. 88.



eye-piece; counteracting its aberrations by substituting a convexo-concave lens for the plano-convex which forms the field-glass of the ordinary Huyghenian eye-piece.<sup>1</sup>

83. *Draw-Tube*.—It is advantageous for many purposes that the Eye-piece should be fitted, not at once into the 'body' of the Microscope, but into an intermediate tube; the drawing-out of which, by augmenting the distance between the objective and the image which it forms in the focus of the eye-glass, still further augments the size of the image in relation to that of the object (§ 25). For although, as a general rule, the magnifying power cannot be thus increased with advantage to any considerable extent, yet, if the corrections of low objectives have been well adjusted, their performance is not seriously impaired by a moderate lengthening of the body; and recourse may be conveniently had to this on many occasions in which some amplification is desired, intermediate between the powers furnished by any two Objectives. Thus, if one objective give a power of 80 diameters, and another a power of 120, by using the first and drawing out the Eye-piece, its power may be increased to 100. Again, it is often very useful to make the object fill up the whole, or nearly the whole, of the field of view; so as to prevent the vividness and distinctness of its image from being interfered with by extraneous light. In the use of the Micrometric eye-pieces to be presently described (§§ 90, 91), very great advantage is to be derived from the assistance of the Draw-tube; as enabling us to make a precise adjustment between the divisions of the Stage-micrometer and those of the Eye-piece micrometer; and as admitting the establishment of a more convenient numerical relation between the two, than could be otherwise secured without far more elaborate contrivances. Moreover, if, for the sake of saving room in packing, it be desired to reduce the length of the body, the draw-tube (in a Monocular Microscope) affords a ready means of doing so.—Objectives of high power, however, require special adjustment when any considerable length of Draw-tube is used.

84.—*Lister's Erector*.—This instrument, first applied to the Compound Microscope by Mr. Lister, consists of a tube about three inches long, having a meniscus at one end and a plano-convex lens at the other (the convex sides being upwards in each case), with a diaphragm nearly half way between them; and this is screwed into the lower end of the draw-tube, as shown in Fig. 59. Its effect is (like the corresponding erector of the Telescope), to antagonize the inversion of the image formed by the object-glass by producing a second inversion, so as to make the Image presented to the eye correspond in position with the Object—an arrangement of great service in cases in which the object has to be subjected to any kind of manipulation. The passage of the rays through two additional lenses of course occasions a certain loss of light and impairment of the distinctness of the image; but this need not be an obstacle to its use for the class of purposes for which it is especially adapted in other respects, since these seldom require a very high degree of defining power. By the position given to the Erector, it is made subservient to another purpose of great utility; namely, the procuring a very extensive range of Magnifying power, without any change in the Objective. For when the draw-tube, with the erector fit-

FIG. 59.



Draw-tube fitted with Erector.

<sup>1</sup> *Op. cit.*, Vol. v. (1880), p. 81.



when the tube is completely pushed-in, the *acting length* of the body (so to speak) is greatly reduced by the formation of the first image much nearer the eye-piece; that, if a lens of 2-3ds of an inch focus be employed, an object of the diameter of  $\frac{1}{4}$  inch can be taken in, and enlarged to no more than 3 diameters, whilst, on the other hand, when the tube is drawn-out  $\frac{1}{4}$  inch, the object is enlarged 100 diameters. Of course every intermediate magnification can be obtained by drawing-out the tube more or less; and the facility with which this can be accomplished, especially when the Draw-tube is furnished with a rack-and-pinion movement (as in Messrs. Beck's Compound Dissecting Microscope), renders such an instrument very useful in various kinds of research.

35. *Micro-Magnscope*.—This designation has been applied by Dr. J. Wilson, to an arrangement of the ordinary Microscope, whereby such a great amplification may be obtained, as gives a general view of large objects, without the need of any special apparatus. The method consists in employing the ordinary microscope to magnify—not the object itself—but an image of it formed by a lens placed between the object and the front of the objective. In the *principle* of this method there is nothing new for every Microscopist who has focussed an Achromatic Condenser, upon a transparent object, has seen the image formed by it of his window-pane, blind-tassel, or (it may be) of sharply defined clouds.\* And Mr. Hoyston-Pigott has been accustomed to employ such images of hairs, fine wires, etc., as 'tests' for the defining quality of Objectives of high magnifying power. The *novelty* consists in the mode of applying it to the purpose just named. This answers best when an Objective of 2 inches or  $\frac{1}{2}$ -inch focus is used in the microscope, and a 1-inch Objective is placed in the Sub-stage with its front-lens upward. The object to be imaged by the latter is to be placed either at some distance behind it, the mirror being turned aside, or, if the Mirror be employed, at some distance from it on either side; the distance, in either case, being adapted to give to the Microscopic image the amplification required. The former arrangement is most convenient if the Microscope is being used in a horizontal position; the latter is most suitable when the Microscope is inclined, the distance of an object placed in the optic axis being then limited. If exact definition is required, the Mirror should be replaced by a right-angled Prism (§ 2). The object, whether transparent or opaque, must be suitably illuminated; and it will be found convenient to use a special support so made that its position and height may be conveniently varied.

36. *Nachet's Erecting Prism*. An extremely ingenious arrangement has been made by M. Nachet, on the basis of an idea first carried into practice by Prof. Amici, by which the inverted image given by the Compound Microscope is erected by a single rectangular prism placed over the eye-piece. The mode in which this prism is fitted up is shown in Fig. 66 (C); the rationale of its action is explained by the diagram (1). The prism is interposed between the two lenses of the Eye-piece, and has somewhat the form of a double wedge, with two pentagonal sides, A B C D E, and e f g h i, which meet each other along the common edge A B, and two faces, n r t u, and c v d u, which meet along the common edge t u, the edges A n and n r being perpendicular to each other. The rays emerging from the field glass enter this prism by its lower surface, and are reflected at t upon the face A n u t g f, from which they are again

\* "Journal of the British Microscopical Club," July, 1879.

\* The Author has thus substituted to his friends a Microscopic view of the Moon.

reflected upon the lower surface at the point K, and thence to the point L upon the vertical face C D G H, and lastly at the point M, upon the other vertical face D E F G; from which the image normally and completely erected, is again sent back, to issue by the superior surface upon which the eye-glass is placed. All the reflections are total except the first at I; and the loss of light is far less than would be anticipated.—The obliquity which this Prism gives to the visual rays, when the Microscope is placed vertically for dissecting or for the examination of objects in fluid, is such as to bring them to the eye at an angle very nearly corresponding with that at which the Microscope may be most conveniently used in the inclined position (§ 41, III.); so that, instead of being an objection, it is a real advantage.

87. *Sorby-Browning Micro-Spectroscope*.<sup>1</sup>—When the Solar ray is decomposed into a colored spectrum by a prism of sufficient dispersive power to which the light is admitted by a narrow slit, a multitude of dark lines make their appearance. The existence of these was originally noticed by Wollaston; but as Fraunhofer first subjected them to a thorough investigation, and mapped them out, they are known as *Fraun-*

FIG. 60.

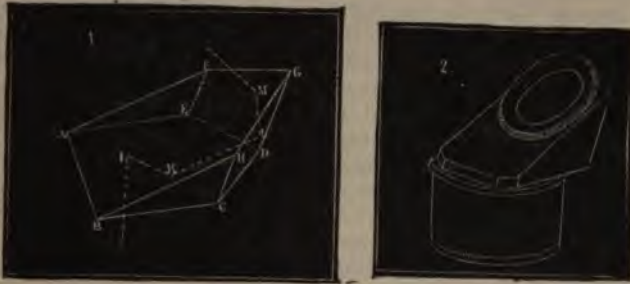

Nacet's Erecting-Prism.

*hofer lines*. The greater the dispersion given by the multiplication of prisms in the Spectroscope, the more of these lines are seen; and they bear considerable magnification. They result from the interruption or absorption of certain rays in the Solar atmosphere, according to the law, first stated by Angström, that "rays which a substance absorbs are precisely those which it emits when made self-luminous." Kirchhoff showed that while the incandescent vapors of Sodium, Potassium, Lithium, etc., give a spectrum with characteristic *bright* lines, the same vapors intercept portions of white light, so as to give *dark* lines in place of the bright ones, absorbing their own special color, but allowing rays of other colors to pass through.—Again, when ordinary light is made to pass through colored bodies (solid, liquid, or gaseous), or is reflected from their surfaces, so as to affect the eye with the sensation of color, its spectrum is commonly found to exhibit absorption *bands*, which differ from the Fraunhofer lines, not only in their greater breadth, but in being more or less *nebulous* or cloudy, so that they cannot be resolved into distinct lines by magnification, while too much dispersion thins them out to indistinct-

<sup>1</sup> For general information on the Spectroscope and its uses, the student is referred to Professor Roscoe's "Lectures on Spectrum Analysis," or the translation of Dr. Schellen's "Spectrum Analysis."

ness. Now, it is by the character of these bands, and by their position in the spectrum, that the colors of different substances can be most accurately and scientifically compared; many colors whose impressions on the eye are so similar that they cannot be distinguished, being readily discriminated by their spectra. The purpose of the Micro-Spectroscope



Micro-Spectroscope.

is to apply the spectroscopic test to very minute quantities of colored substances; and it fundamentally consists of an ordinary Eye-piece (which can be fitted into any Microscope) with certain special modifications. As originally devised by Mr. Sorby, and worked-out by Mr. Browning, the Micro-Spectroscope is constructed as follows (Fig. 61):—Above its Eye-glass, which is achromatic, and made capable of focal adjustment by the milled-head B for rays of different re-

frangibilities, there is placed a tube A, containing a series of five prisms, two of flint-glass (Fig. 62, F F) interposed between three of crown (C O C), in such a manner that the emergent rays *r r*, which have been separated

Fig. 62.



Arrangement of prisms in Spectroscopic Eye-piece.

by the dispersive action of the flint-glass prisms, are parallel to the rays which enter the combination. Below the eye-glass, in the place of the ordinary stop, is a diaphragm with a narrow slit, which limits the admission of light; this can be adjusted in vertical position by the milled-head H, whilst

the breadth of the slit is regulated by c. The foregoing, with an Objective of suitable power, would be all that is needed for the examination of the spectra of objects placed on the stage of the Microscope, whether opaque or transparent, solid or liquid, provided that they transmit a sufficient amount of light. But as it is of great importance to make exact comparisons of such artificial spectra, alike with the ordinary or natural Spectrum, and with each other, provision is made for the formation of a second spectrum, by the insertion of a right-angled prism that covers one-half of this slit, and reflects upwards the light transmitted through an aperture seen on the right side of the eye-piece. For the production of the ordinary spectrum, it is only requisite to reflect light into this aperture from the small mirror I, carried at the side; whilst for the production of the spectrum of any substance through which the light reflected from this mirror can be transmitted, it is only necessary to place the slide carrying the section or crystalline film, or the tube containing the solution, in the frame D D adapted to receive it. In either case, this second spectrum is seen by the eye of the observer alongside of that produced by the object viewed through the body of the Microscope, so that the two can be exactly compared.

88. The exact position of the Absorption-bands is as important as that of the Fraunhofer-lines; and some of the most conspicuous of the latter afford fixed points of reference, provided the same Spectroscope be employed. The amount of dispersion determines whether the Fraunhofer-lines and Absorption-bands are seen nearer or farther apart; their actual positions in the field of view varying according to the dispersion, while their relative positions are in constant proportion.—The best contrivance

for measuring the spectra of absorption bands is Browning's Bright-line Micrometer shown in Fig. 63. At *R* is a small mirror by which light from the lamp employed can be reflected through *E D* to the lens *C*, which, by means of a perforated stop, forms a bright pointed image on the surface of the upper prism, whence it is reflected to the eye of the observer. The rotation of a wheel worked by the milled-head *M* carries this bright point over the spectrum, and the exact amount of motion may be read off to 1-10,000th inch on the graduated circle of the wheel. To use this apparatus, the Fraunhofer lines must be viewed by sending bright daylight through the spectroscope, and the positions of the principal lines carefully measured, the reading on the micrometer-wheel being noted down. A Spectrum-map may then be drawn on cardboard, on a scale of equal parts; and the lines marked on it, as shown in the upper half of Fig. 64. The lower half of the same figure shows an Absorption-spectrum, with its bands at certain distances from the Fraunhofer lines. The cardboard Spectrum-map, when once drawn, should be kept for reference.<sup>1</sup>

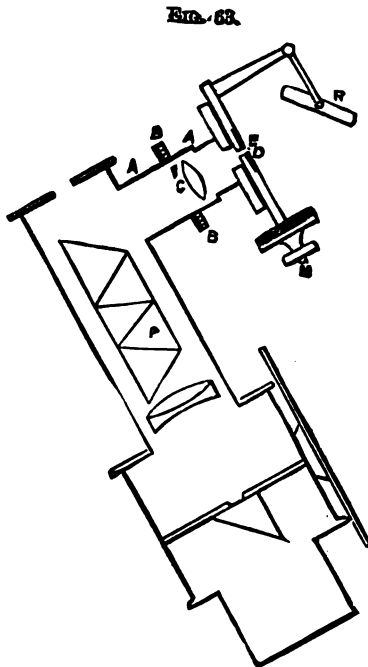

Bright-line Spectro-Micrometer.

89. A beginner with the Micro-Spectroscope should first hold it up to the sky on a clear day, without the intervention of the microscope, and note the effects of opening and closing the slit by rotating the screw *c* (Fig. 61); the lines can only be well seen when the slit is reduced to a narrow opening. The screw *H* diminishes the length of the slit, and causes the spectrum to be seen as abroad or a narrow ribbon. The screw *E* (or in some patterns two small sliding-knobs) regulates the quantity of light admitted through the square aperture seen between the points of the springs *D D*.—Water tinged with port wine, madder, and blood, are good fluids with which to commence this study of absorption-bands. They may be placed in small test tubes, in flat glass cells, or in wedge-shaped cells.<sup>2</sup> As each color varies in refrangibility, the focus must be adjusted by the screw *B*, Fig. 61, according to the part of the spectrum that is examined.—When it is desired to see the spectrum of an exceedingly

<sup>1</sup> Mr. Swift has devised an improved Micro-Spectroscope, in which the Micro-metric apparatus is combined with the ordinary Spectroscopic Eye-piece, and two spectra can be brought into the field at once.—Other improvements devised by Mr. Sorby, and a new form devised by Mr. F. H. Ward, have been carried into execution by Mr. Hilger. (See "Journ. of Roy. Microsc. Soc.," Vol. i., 1878, p. 326, and Vol. ii., 1879, p. 81.) Another construction possessing some advantages over the original form, has been devised by Zeiss of Jena (See "Journ. of Roy. Microsc. Soc.," Vol. iii., 1880, p. 708).

<sup>2</sup> A series of specimens, in small tubes, for the study of Absorption-spectra, is kept on sale by Mr. Browning; and the directions given in his "How to Work with the Micro-Spectroscope" should be carefully attended to.



minute object, or of a small portion only of a larger one, the prisms are to be removed by withdrawing the tube containing them; the slides should then be opened wide, and the object, or part of it, brought into the centre of the field; the vertical and horizontal slits can then be partly shut, so as to include it, and if the prisms are then replaced, and a suitable objective employed, the required spectrum will be seen unaffected by adjacent objects. For ordinary observations, Objectives of from 2 inches to 2- $\frac{1}{2}$  inch focus will be found most suitable; but for very minute quantities of material a higher power must be employed. Even a single Red blood corpuscle may be made to show the characteristic Absorption-bands represented (after Prof. Stokes) in Fig. 65.<sup>1</sup>

90. *Micrometric Apparatus.*—Although some have applied their micrometric apparatus to the Stage of the Microscope, yet it is to the Eye-piece that it may be most advantageously adapted.<sup>2</sup> The *Cobweb Micrometer*, invented by Ramsden for Telescopes, is probably, when well constructed, the most perfect instrument that the Microscopist can em-

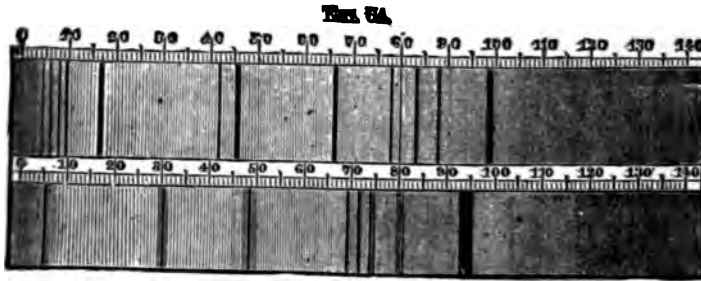

Upper half, Map of Solar Spectrum, showing Fraunhofer lines. Lower half, Absorption Spectrum, showing position of Bands in relation to lines.

ploy. It is made by stretching across the field of an Eye-piece two very delicate parallel wires or spider's threads, one of which can be separated from the other by the action of a micrometer screw, the head of which is divided at its edge into a convenient number of parts, which successively pass-by an index, as the milled-head is turned. A portion of the field of view on one side is cut off at right angles to the filaments, by a scale formed of a thin plate of brass having notches at its edge, whose distance corresponds to that of the threads of the screw, every fifth notch being made deeper than the rest for the sake of ready enumeration. The object being brought into such a position that one of its edges seems

<sup>1</sup> For further information on "The Spectrum Method of Detecting Blood," see an important paper by Mr. Sorby, in "Monthly Micros. Journal," Vol. vi. (1871), p. 9.

<sup>2</sup> The Stage-Micrometer constructed by Fraunhofer is employed by many Continental Microscopists; but it is subject to this disadvantage—that any error in its performance is augmented by the *whole* magnifying power employed; whilst a like error in the Eye-piece Micrometer is increased by the magnifying power of the eye-piece alone.—Dr. Royston-Pigott has pointed out ("Monthly Micros. Journ.," Vol. ix., 1873, p. 2.), that by placing the Cobweb Micrometer at some distance beneath the stage, and by forming an *aerial image* of it (by an interposed lens) in the plane of the object; the delicacy and accuracy of its measurements may be greatly increased; the numerical value of each division being reduced, in proportion to the reduction in the size of the aerial image, which will of course be determined by the focal length of the lens that forms it, and by the distance of the Micrometer beneath it.

to touch the stationary filament, the other thread is moved by the micrometer-screw until it appears to lie in contact with the other edge of the object; the number of the entire divisions on the scale shows how many complete turns of the screw must have been made in thus separating the filaments, while the number to which the index points on the milled-head shows what fraction of a turn may have been made in addition. It is usual, by employing a screw of 100 threads to the inch, to give to each division of the scale the value of 1-100th of an inch, and to divide the milled-head into 100 parts; but the *absolute* value of the divisions is of little consequence, since their *micrometric* value depends upon the Objective with which the instrument may be employed. This must be determined by means of a ruled slip of glass laid upon the stage; and as the distance of the divisions even in the best-ruled slips is by no means uniform, it is advisable to take an average of several measurements, both upon different slips, and upon different parts of the same slip.

Here the Drawtube will be of essential use, in enabling the Microscopist to bring the value of the divisions of his Micrometer to *even numbers*.—The Microscopist who applies himself to researches requiring micrometric measurement, should determine the value of his Micrometer with each of the Objectives he is likely to use for the purpose; and should keep a table of these determinations, recording in each case the extent to which the tube has been drawn out, as marked by the graduated scale of inches which it should possess. And he should also make an accurate estimate of the thickness of the Cobweb-threads themselves; since, if this be not properly allowed for, a serious error will be introduced into the measurements made by this instrument, especially when the spaces measured are extremely minute. (See



1, Spectroscopic appearance of fresh Scarlet Blood; 2, of Deoxydized Blood (cruorine); 3, of Hematin, obtained by acting on cruorine with an acid; 4, of Hematin reoxydized.

Michell, in "Transact. Micros. Soc." N. S., Vol. xiv., p. 71.)

91. The costliness of the Cobweb Micrometer being an important obstacle to its general use, a simpler method (devised by Mr. G. Jackson) is more commonly adopted; which consists in the insertion of a transparent scale into an ordinary Huyghenian Eye-piece in the focus of the eye-glass, so that the image of the object is seen to be projected upon it. This scale is ruled like that of an ordinary measure (*i.e.*, with every tenth line *long*, and every fifth line half its length) on a slip of glass, which is so fitted into a brass frame (Fig. 66, B), as to have a slight motion towards either end; one of its extremities is pressed-upon by a fine milled-head screw which works through the frame, and the other by a spring (concealed in the figure) with antagonizes the screw. The scale thus mounted is introduced through a pair of slits in the Eye-piece tube, immediately above the diaphragm (Fig. 66, A), so as to occupy the centre of the field;

and it is brought accurately into focus by unscrewing the eye-glass until the lines of the scale are clearly seen. The value of the divisions of this scale must be determined by means of a ruled Stage-micrometer, as in the former instance, for each Objective employed in micrometry, the use of the Draw-tube enabling the proportions to be adjusted to even and convenient numbers); and this having been accomplished, the scale is brought to bear upon the object to be measured, by moving the latter as nearly as possible into the centre of the field, and then rotating the Eye-piece in such a manner that the scale may lie across that diameter which it is desired to measure. The pushing screw at the extremity of the scale being then turned until one edge of the object appears to be in exact contact with one of the long lines, the number of divisions which its diameter

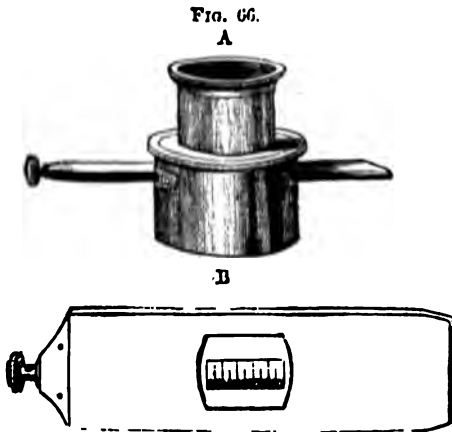

Jackson's Eye-piece Micrometer.

occupies is at once read-off by directing the attention to the other edge—the operation being nothing more than laying a rule across the body to be measured.<sup>1</sup> This method of measurement may be made quite exact enough for all ordinary purposes, provided, in the first place, that the Eye-piece scale be divided with a fair degree of accuracy; and secondly, that the value of its divisions be ascertained (as in the case of the Cobweb-Micrometer) by several comparisons with a ruled scale laid upon the Stage. Thus if, by a mean of numerous observations, we establish the value of each division of the eye-piece scale to be 1-12,500th of an inch, then, if the image of an object be found to measure  $3\frac{1}{2}$  of those divisions, its real diameter will be  $3\frac{1}{2} \times \frac{1}{12500}$  or  $\frac{1}{3750}$  inch.<sup>2</sup> With an Objective of 1-12th-inch focus, the value of the divisions of the Eye-piece scale may be reduced to 1-25,000th of an inch; and as the eye can estimate a fourth part of one of the divisions with tolerable accuracy, it follows that a magnitude of as little as 1-100,000th of an inch can be measured with a near approach to exactness.—Even this exactness may be increased by the application of the *diagonal scale* (Fig. 67) devised by M. Hartnack. The

<sup>1</sup> Dr. Royston-Pigott (*loc. cit.*) prefers to introduce into the aperture of the diaphragm a plano-convex lens of very long focus, with the lines engraved upon its flat surface. The advantage of the screw-movement is sacrificed, but a greater distinctness of the lines is obtained.

<sup>2</sup> The calculation of the dimensions is much simplified by the adoption of a Decimal scale; the value of each division being made, by the use of the Draw-tube adjustment, to correspond to some aliquot part of a ten-thousandth or a hundred-thousandth of an inch, and the dimensions of the object being then found by simple multiplication:—Thus (to take the above example) the value of each division in the decimal scale is .00008, and the diameter of the object is .00028. The Metric system being now universally employed on the Continent, many British and American Microscopists prefer to record their observations in parts of a Millimetre; and with a view to their convenience Messrs. Beck supply Stage-Micrometers ruled on one side of a median line to 100ths and 1000ths of an Inch, and on the other side to 100ths of a Millimetre.



vertical lines are crossed by two parallel lines, at a distance from each other of five divisions of the vertical scale; and the parallelogram thus formed is crossed by a diagonal. It is obvious from this construction, that the lengths of the lower segments of the 50 vertical lines, cut off by the diagonal, will progressively increase from .1 to 5.0; so that when it is desired to obtain an exact measurement of an object between these limits it is only requisite to find the segment whose length precisely coincides with the diameter to be taken, which it will then give in *tenths* of the value of the vertical divisions, whatever these may be. Thus, at *a*, the length of the segment will be 1.8; at *b* it will be 3.4.—Whatever method be adopted, if the measurement be made in the Eye-piece and not on the stage, it will be necessary to make allowance for the adjustment of the Object-glass to the thickness of the glass that covers the object, since its magnifying power is considerably affected by the separation of the front pair of lenses from those behind it (§ 17). It will be found convenient to compensate for this alteration by altering the Draw-tube in such a manner as to neutralize the effect produced by the adjustment of the Objective; thus giving one uniform value to the divisions of the Eye-piece scale, whatever may be the thickness of the covering-glass; the amount of the alteration required for each degree must of course be determined by a series of measurements with the Stage-micrometer.—Metric measurements may also be made with the Camera Lucida, in the manner to be presently described, or with Dr. Beale's neutral tint reflector (§ 94).

92. *Goniometer*.—When the Microscope is employed in researches on minute Crystals, their angles may be measured by adapting a Goniometer to the Eye-piece; but as all First-Class Microscopes are now provided with rotating Stages graduated at their edges, with the addition of a Vernier-scale if desired, the measurement may be more conveniently made by giving rotation to the object. An Eye-piece is required whose field is traversed diametrically by a *fixed line* (either a filament stretched across it, or a line ruled on glass), and is turned so as to bring this line into coincidence with one of the lines forming the angle to be measured, when the Stage is at zero; the stage is then rotated until the fixed line coincides with the other line of the angle, and the amount of movement is read-off on the scale.—If a higher degree of precision be required than either of these methods is fitted to afford, the *Double Refracting Goniometer*, invented by Dr. Leeson, may be substituted.<sup>1</sup>

93. *Diaphragm Eye-piece*.—It is often useful to cut off the light surrounding the object or part of the object to be examined; for the sake alike of avoiding glare that is injurious to the eye, and of rendering the features of the object more distinct. This may be accomplished on the plan of Mr. Slack, by the introduction, just above the ordinary 'stop,' of

FIG. 67.



Hartnack's Eye-piece Micrometer.

<sup>1</sup> For a description of this instrument, see Dr. Leeson's description of it in Part xxxiii. of the "Proceedings of the Chemical Society," and Mr. Richard Beck's "Treatise on the Microscope," p. 65.



four small shutters, worked by as many milled-heads projecting slightly beyond the flange of the eye-piece. By combining the movements of these shutters in various ways, it is easy to form a series of symmetrical apertures, bounded by straight lines, and of any dimensions required. As remarked by its inventor, this Diaphragm Eye-piece may also be used to isolate one out of many objects that may be on the same slide, and thus to show that object alone to persons who might not otherwise distinguish it.—For this last purpose the *Indicator* of Mr. Quekett may also be used; which is a small steel hand placed just over the diaphragm, so as to point to nearly the centre of the field, whilst it may be turned back when not required, leaving the field of view quite free. The particular object or portion of the object to which it is desired to direct attention, being brought to the extremity of the hand, is thus at once 'indicated' to any other observer.

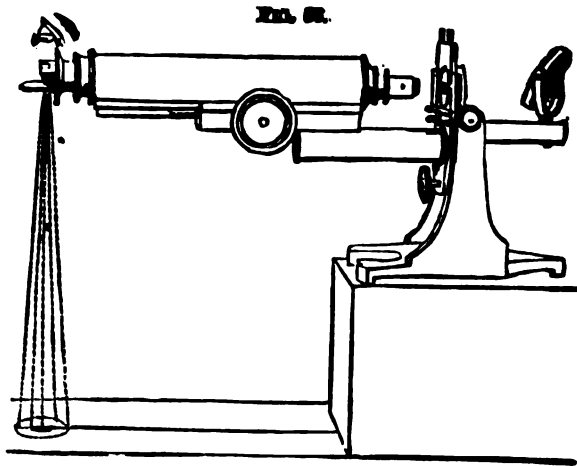

Microscope arranged with Camera Lucida, for Drawing or Micrometry.

94. *Camera Lucida and other Drawing Apparatus.*—Various contrivances may be adapted to the Eye-piece, in order to enable the observer to see the image projected upon a surface whereon he may trace its outlines. The one most generally employed is the *Camera Lucida prism* contrived by Dr. Wollaston for the general purposes of delineation; this being fitted on the front of the eye-piece, in place of the 'cap' by which it is usually surmounted. The Microscope being placed in a horizontal position, as shown in Fig. 68, the rays which pass through the eye-piece into the prism sustain such a total reflection from its oblique surface, that they come to its upper horizontal surface at right angles to their previous direction; and the eye being so placed over the edge of this surface as to receive these rays from the prism through part of the pupil, whilst it looks with the other half beyond the prism down to a white paper surface on the table, it sees the image so strongly and clearly projected upon that surface, that the only difficulty in tracing it arises from a certain incapacity which seems to exist in some individuals for seeing the image and the tracing-point at the same time. This difficulty (which is common to all instruments devised for this purpose) is lessened by the interposition of a slightly convex lens in the position shown in the figure, between the

and the paper, in order that the rays from the paper and tracing-point may diverge at the same angle as those which are received from the object; and it may be generally got over altogether, by experimentally varying the relative degrees of light received from the object and from the paper. If the image be too bright, the paper, the tracing-point, and the outline it has made, are scarcely seen; and either less light may be allowed to come from the object, or more light (as by a taper held near, or thrown on the paper and tracing-point. Sometimes, on the other hand, measures of the contrary kind must be taken.—Another instrument for the same purpose, invented by the celebrated anatomist N. P. L. N. and preferred by some Microscopists, is a flat *speculum* of polished steel or speculum-metal, of smaller diameter than the ordinary eye-piece, fixed at an angle of  $45^\circ$  in front of the eye-piece. The rays from the eye-piece are reflected vertically upwards to the central part of the pupil placed above the mirror, whilst, as the eye also receives rays from the paper and tracer in the same direction, through the peripheral

FIG. 69.



Chevallier's Camera Lucida.

FIG. 70.

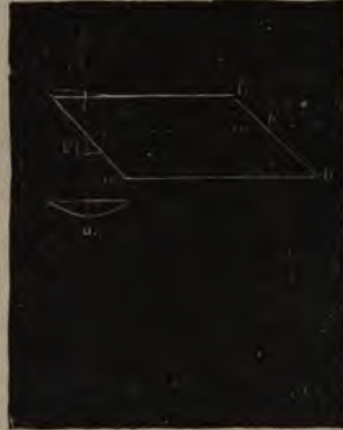

Nacet's Camera Lucida.

of the pupil, the image formed by the Microscope is visually projected downwards.—In another form of Camera Lucida, devised by Amici, adapted to the horizontal microscope by Chevallier, the eye looks through the Microscope at the object (as in the ordinary view of it), instead of looking at its projection upon the paper, the image of the object-point being projected upon the field—an arrangement which is in many respects more advantageous. This is effected by combining a perished steel mirror with a reflecting prism; and its action will be understood by the accompanying diagram (Fig. 69). The ray  $ab$  proceeding from the object, after emerging from the eye-piece of the Microscope, passes through the central perforation in the oblique mirror  $M$ , which is placed at an angle of  $45^\circ$  to the optical axis, and so directly onwards to the eye. On the other hand, the ray  $a'$  proceeding upwards from the tracing-point, enters the prism  $P$ , is reflected from its inclined surface to the inclined surface of the mirror  $M$ , and is by it reflected to the eye at  $b'$ , in such parallelism to the ray  $b$  coming from the object, that the two blend into one image.—The

same effect is produced by a contrivance which has been devised by MM. Nachet for use with vertical Microscopes, and is much employed on the Continent. It consists of a prism of a nearly rhomboidal form (Fig. 70), which is placed with one of its inclined sides A C, over the eye-piece of the Microscope; to this side is cemented an oblique segment E, of a small glass cylinder, which presents to the ray  $a b$ , proceeding directly upwards from the object, a surface at right angles to it; so that this ray passes into the small cylinder E, and out from the side A B, of the larger prism, without sustaining any refraction, and with very little loss by reflection from the inclined surfaces at which they join. But the ray  $a' b'$ , which comes from the tracing point on a paper at the end of the base of the Microscope, entering the rhomboidal prism, is reflected from its inclined side B D, to its inclined side A C, and thence it is again reflected to  $b$ , in coincidence with the ray which has directly proceeded from the object. As the ray  $a' b'$  is necessarily oblique, the picture visually projected on the paper will be distorted, unless the right side of the drawing-board be raised, so that its plane shall be at right angles to  $a' b'$ .—Of the numerous contrivances for drawing from the Microscope, the simplest and by no means the least effective, is the *Neutral Tint Reflector*, recommended by Dr. Beale, which consists of a piece of neutral-tint glass, set in a cap fitted on the Eye-piece, with which it makes an angle of  $45^\circ$ . The Microscope being arranged as in Fig. 68, the eye, looking downwards, receives at the same time the image-forming rays from the eye-piece, which come to it by reflection from *the surface* of the glass, and those from the paper, tracing-point, or rule, which pass to it *through* the glass. A simple and inexpensive substitute for this, which its inventor (Mr. T. B. Jennings, U.S.) has found very efficient, may be made by taking a flat cork about  $1\frac{1}{4}$  inch in diameter, cutting a hole in it sufficiently large to enable it to fit tightly on the Eye-piece (without its cap), and then making a transverse slit beneath the hole, into which is to be inserted a thin-glass cover at an angle of  $45^\circ$ .

95. With one or other of the foregoing contrivances, every one may learn to draw an outline of the Microscopic image; and it is extremely desirable for the sake of accuracy, that every representation of an object should be based on such a delineation. Some persons will use one instrument most readily, some another; the fact being that there is a sort of a "knack" in the use of each, which is commonly acquired by practice alone, so that a person accustomed to the use of any one of them does not at first work well with another. Although some persons at once acquire the power of seeing the image and the tracing-point with equal distinctness, the case is more frequently otherwise; and hence no one should allow himself to be baffled by the failure of his first attempt. It will sometimes happen, especially when the Wollaston prism is employed, that the want of power to see the pencil is due to the faulty position of the eye, too large a part of it being over the prism itself. When once a good position has been obtained, the eye should be held there as steadily as possible, until the tracing shall have been completed. It is essential to keep in view that the proportion between the size of the tracing and that of the object is affected by the distance of the eye from the paper; and hence that if the Microscope be placed upon a support of different height, or the Eye-piece be elevated or depressed by a slight inclination given to the body, the scale will be altered.—This it is, of course, peculiarly important to bear in mind, when a series of tracings is being made of any set of objects which it is intended to delineate on a uniform

scale; or when the Camera Lucida (or any similar arrangement) is employed for the purpose of *Micrometry*. All that is requisite to turn it to this account, is an accurately divided Stage-micrometer, which, being placed in the position of the object, enables the observer to see its lines projected upon the surface upon which he has drawn his outline; for if the divisions be marked upon the paper, the average of several taken, and the paper then divided by parallel lines at the distance thus ascertained (the spaces being subdivided by intermediate lines, if desirable), a very accurate scale is furnished, by which the dimensions of any object drawn in outline under the same power may be minutely determined. Thus, if the divisions of a Stage-micrometer, the real value of each of which is a 100th of an inch, should be projected on the paper with such a magnifying power as to be at the distance of an inch from one another, it is obvious that an ordinary inch-scale applied to the measurement of an outline would give its dimensions in 100ths of an inch, whilst each tenth of that scale would be the equivalent of a 1,000th of an inch. When a sufficient magnifying power is used, and the dimensions of the image are measured by the 'diagonal' scale (which subdivides the inch into 1,000 parts), great accuracy may be obtained. It was by the use of this method, that Mr. Gulliver made his admirable series of measurements of the diameters of the Blood-corpuscles of different animals.—In using Nacet's vertical Camera for Micrometry, care must be taken so to adjust the slope of the drawing-board, that the Micrometer scale shall be projected on the paper without distortion.

96. *Nose-piece*.—It is continually desirable to be able to substitute one objective for another with as little expenditure of time and trouble as possible; so as to be able to examine under a higher magnifying power the details of an object of which a general view has been obtained by means of a lower; or to use the lower for the purpose of *finding* a minute object (such as a particular Diatom in the midst of a slide-full) which we wish to submit to high amplification. This is effected by the *Nose-piece* of Mr. C. Brooke, which, being screwed into the object-end of the body of the Microscope, carries two objectives, either of which may be brought into position by turning the arm on a pivot. In its original form, the arm was straight; so that the Objective *not* in use was often brought own upon the Stage, unless the relative lengths of the two objectives were specially adjusted. This inconvenience is avoided, however, in the construction adopted by Messrs. Powell and Lealand, and further simplified by Mr. Swift (Fig. 71); the bend given to the arm having the effect of keeping the Objective not in use completely off the stage. The working Microscopist will scarcely find any Accessory more practically useful to him than this simple piece of apparatus.

97. *Finders*.—All Microscopists occasionally, and some continually, feel the need of a ready means of *finding*, upon a glass slide, the particular object, or portion of an object, which they desire to bring into view; and various contrivances have been suggested for the purpose. Where different magnifying powers can be readily substituted one for another,

FIG. 71.



Swift's Improved Nose-piece.



as by the use of the Erector (§ 84) or of the Nose-piece, no special means are required; since, when the object has been found by a low power, and brought into the centre of the field, it is rightly placed for examination by any other Objective. Even this slight trouble, however, may be saved by the adoption of more special methods; among the simplest of which is *marking* the position of the object on the surface of the thin glass which covers it. The readiest mode of doing this, when the object is large enough to be distinguished by the naked eye or under the Simple Microscope, is to make a small ring round it with a fine camel's-hair pencil dipped in Asphalte, or Brunswick black (Indian ink being objectionable, as liable to be washed off when water-immersion Objectives are in use); but when the object is not thus visible, the slide must be laid in position on the stage, the object 'found' in the Microscope, the Condenser adjusted to give a bright and defined circle of light, and then, the Microscope-body being withdrawn, the black ring is to be marked around the illuminated spot. This method, however, has the disadvantage of concealing any other objects that may lie in close proximity to the one around which the circle is drawn; and recourse must be had in such cases to some other plan. The Mechanical Stage may be easily turned to account as a *finder*, by engraving upon it two scales, *horizontal* and *vertical*, by which the object-platform may be exactly set to any desired position; this platform being itself provided with a removable 'stop,' against which the glass slide (resting on its lower edge) may so abut, as always to occupy the same place on the platform. Now supposing an observer to be examining a newly-mounted slide, containing any object which he is likely to wish to find on some future occasion, he first lays the slide on the object-platform, with its lower edge resting on the ledge, and its end abutting against the lateral stop, and brings the object-platform itself to the *zero* of the scales; then, whenever, on moving the slide by the traversing action, he meets with any particular form worthy of note, he reads off its position upon the two scales, and records it in any convenient mode. The scale may be divided to 50ths of an inch, and each of these spaces may be again halved by the eye; and the record may perhaps be best made thus,—*Triceratium favus* <sup>26</sup> <sub>18½</sub>

upper number marking the 'latitude' of the object on the vertical scale, and the lower its 'longitude' on the horizontal. Whenever the Microscopist may wish again to bring this object under examination, he has merely to lay the slide in the same position on the platform, and to adjust the platform by its scales according to the recorded numbers.—The 'finder' most commonly used is that invented by Mr. Maltwood,<sup>1</sup> which consists of a glass slide 3 inches by 1½ inch, on which is *photographed* a scale that occupies a square inch and is divided by horizontal and vertical lines at 1-50th of an inch apart into 2,500 squares, each of which contains two numbers, one marking its 'latitude' or place in the vertical series, and the other its 'longitude' or place in the horizontal series.

<sup>1</sup> This plan, first suggested by Mr. Okeden, might be adopted with so little trouble or expense in every Microscope possessed of a Mechanical stage, that it would be very desirable for every such Microscope to be furnished with these graduated scales. If the different Makers would agree to use the 1-50th inch scale, Observers at a distance from one another, who might wish to examine each other's objects, would have no difficulty in finding them by the record of their positions accompanying each slide.

<sup>2</sup> 'Transactions of the Microscopical Society,' N. S., Vol. vi. (1868), p. 59.

The slide, when in use, should rest upon the ledge of the stage of the Microscope, and be made to abut against a stop about  $1\frac{1}{2}$  inch from the centre of the stage.—In order to use this 'finder,' the Object-slide must be laid upon the Stage in such a manner as to rest upon its ledge and to abut against the stop; and when some particular object, whose place it is desired to record, has been brought into the field of view, the object-slide being removed and the 'finder' laid down in its place, the numbers of the square then in the field are to be read off and recorded. To find that object again at any time, the 'finder' is to be laid in its place on the stage, and the stage moved so as to bring the recorded number into view; and the object-slide being then substituted for the finder, the desired object will present itself in the field. As care is taken in the production of each 'Maltwood,' that the scale shall be at an exact distance from the bottom and left-hand end of the glass slide, the Microscopist may thus enable any other observer provided with a similar 'finder' to bring into view any desired object, by informing him of the numbers that mark its latitude and longitude. These numbers may either be marked upon the object-slide itself, or recorded in a separate list.<sup>1</sup>

98. *Diaphragms*.—Every Microscope should be provided with some means of regulating the amount of light sent upwards from the Mirror through transparent objects under examination. This is usually accomplished by means of a *Diaphragm-plate*, perforated by apertures of different sizes (the smallest of which should be no larger than a pin-hole), and pivoted to a removable fitting attached to the under side of the Stage, in such a manner that by rotating the plate, either of the apertures can be brought into the optic axis of the instrument. The largest of its apertures should be made to carry a ground-glass (so fitted as to be removable at pleasure), the use of which is to diffuse a soft and equable light over the field when large transparent objects are under examination with a low power; while between the smallest and the largest aperture there should be an unperforated space, to serve as a dark background for Opaque objects. The edge of the Diaphragm-plate should be notched at certain intervals, and a spring-catch fitted so as to drop into the notches, in order that each aperture may be brought into its proper central position. When the Diaphragm-plate is used to improve the definition of high powers, it loses much of its value if its aperture be not *very close* to the under side of the object-slide; and any arrangement which sets it at some distance beneath the stage is consequently objectionable. Its best position is *in the thickness* of the stage, which, for receiving it, is

<sup>1</sup> The only drawback to the utility of the Maltwood finder lies in the fact that a single square more than covers the field taken in by 1-4th Objective with the A eye-piece; so that with powers many times as great, the proportion of the square viewed at once is so small, as to make it impossible to fix the place of the object with any precision. To obviate this difficulty, Mr. W. Webb proposes a finder ruled with lines only 1-200th of an inch apart, so as to divide a square of only 8-4th of an inch into 22,500 squares. As it would be impossible to mark distinguishing numerals within squares of such minuteness, he rules stronger lines at intervals, so as to divide the whole area into 'blocks' of 100 squares in each; and any individual square can be easily described (1) by the block in which it lies, and (2) by its position in that block. ("Journ. of Roy. Microsc. Soc.," Vol. iii., 1860, p. 750).—To those who prefer the simplicity given by the numbering of each square in the Maltwood finder, the Author would suggest that the object may be always 'found' by it with the 1-4th Objective; and that, if thus brought into the centre of its field, the object will lie within the field of any Objective of higher power, provided the centering of the two be conformable.

... different diameters may be ... with a cylindrical ... apparatus. A ... upon ... of different sizes, so ... with the sur- ... according ... light may ... perforated ... as a back- ... from ... who de- ... with one of ... introduced. ... is equally ... square ... use. In ... shutters are



Collins's Graduating Diaphragm.

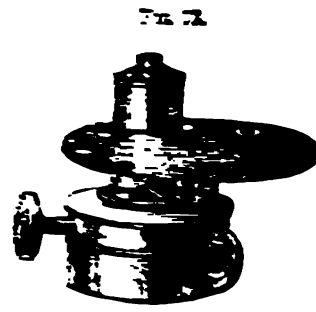

Wade's Achromatic Condenser.

... to move inwards simultaneously, by acting on a lever-handle, so as ... the aperture, the shape of which always remains more nearly circular than square. And in the 'Iris Diaphragm' devised by Mr. J. H. Brown, the multiplication of the number of shutters makes the aperture practically circular. The new construction of this, devised by Mr. Geo. Wade, U. S., is so simple, inexpensive, and effectual, that its general adoption in place of the Diaphragm-plate may be anticipated.

99. *Achromatic Condensers.*—In almost every case in which an Objective of 1.4th inch or any shorter focus is employed, its performance is greatly improved by the interposition of an Achromatic combination *between* the mirror and the object, in such a manner that the rays reflected from the former shall be brought to a focus in the spot to which the object is directed. A distinct picture of the source of light is thus thrown on the object, from which the rays emanate again as if it were *self-luminous*. The Achromatic combination, which (at least in all *high-power* Microscopes) is one specially adapted to the purpose, is furnished with a Diaphragm-plate immediately beneath its lowest lens (Fig. 73), which is pierced with holes of such forms and sizes as to cut off *more or less*, not merely the peripheral but also the central part of

the illuminating pencil, or to allow oblique light to pass only in some one azimuth, or in two azimuths at right angles to each other. The Achromatic Condenser of Messrs. Beck is a combination of three pairs, of which the first and second are removable, so that the back pair may be used alone for the illumination of objects viewed with low or medium powers.—The Achromatic Condenser of Messrs. Powell and Lealand has an angular aperture of  $170^\circ$ , and thus transmits rays of extreme obliquity through objects mounted on thin glass; all other rays being excluded (if desired) by a special arrangement of stops. The Diaphragm-plate being perforated by apertures of different sizes, the largest of these (which transmits the entire pencil) can be partially closed by centric or eccentric stops attached to a separate arm, any one of which can be brought into the optic axis; and thus, whilst the graduated apertures of the diaphragm-plate limit the *peripheral* portion of the pencil, the stops cut off its *central*, allowing the transmission either of its entire peripheral portion, or of the rays proceeding only from some special part or parts of it.

FIG. 74.



Beck's New Achromatic Condenser.

FIG. 75.



Webster's Condenser, fitted with Collins's Graduating Diaphragm.

The same eminent makers have lately introduced a Non-achromatic Oil-immersion Condenser; which, at a much lower cost, serves for the resolution of the most difficult tests, their illumination by colored rays not being found practically objectionable.—In the Achromatic Condenser now made by Messrs. Ross, extreme obliquity of the illuminating rays is not provided for, this being obtained by means of their swinging 'tail-piece' (§ 72). Its combination has a focus of about 4-10ths inch; and beneath its back-lens, which has an aperture of half an inch, is an Iris-diaphragm for reducing it in any desired degree, with a rotating diaphragm-plate having a set of stops adapted to limit the aperture and to give a 'black-ground' illumination under objectives of different angular apertures.—Messrs. Beck have recently introduced a new Achromatic Condenser with a front revolving eccentrically (Fig. 72), by which means its focus may be varied, and a 'black-ground' illumination may be obtained suitable for objectives having angles as high as  $120^\circ$ .

100. *Webster Condenser*.—Though the original idea of the arrangement which has come into general use under this designation, and which is at the same time comparatively inexpensive and applicable to a great variety of purposes, was given by Mr. J. Webster ("Science Gossip," April 1st, 1865), it has received important modifications at the hands of the Opticians by whom the instrument is manufactured; and has, perhaps, not even yet undergone its full development. In its present form



the arrangement of the lenses strongly resembles that used in the Kellner eye-piece (§ 28); the field-glass of the latter serving as a condenser to receive the cone of rays reflected upwards from the mirror, and to make it converge upon a small Achromatic combination, which consists of a double-convex lens of crown, with a plano-convex lens of flint, the plane side of the latter being next the object. These lenses are of large size and deep curvature; so that when their central part is stopped-out, the rays transmitted from their *peripheral* portion meet at a wide angle of convergence, and have the effect of those transmitted through the peripheral portion of the ordinary Achromatic Condenser. When, on the other hand, this combination is used with a diaphragm that allows only the *central* rays to pass, these rays meet at a small angle; and the illumination thus given is very suitable for objects viewed with low powers. Again, by stopping-out the central portion of the combination; and removing the Condenser to a short distance beneath the object, the effect of a 'black-ground' illumination (§ 104) can be very satisfactorily obtained with Objectives of low or moderate angular aperture. Further, by stopping-out not only the central but also a great part of the peripheral rays, so as only to allow the light to enter from a small portion or portions of the margin, illumination of considerable obliquity can be obtained. All this can be provided for by a Diaphragm-plate made to rotate at as short a distance as possible beneath the condensing-lens; but as the number of apertures in this plate is necessarily limited, a greater variety is obtained by the use of a Graduating Diaphragm (§ 98) for the regulation of the centric aperture, and by making the apertures in the rotating plate subservient to the other purposes already named, as is done in the arrangement of Mr. Collins (Fig. 75).—Still greater variety can be obtained by substituting for the Diaphragm-plate a short tube sliding within the one that carries the lenses; its summit being furnished with a socket into which may be inserted a diaphragm of blackened card or of thin metal, with an aperture or apertures of any shape or size that may be desired. In this manner the diaphragm may be carried up quite close to the condensing lens, which is a great advantage; and when oblique illumination is desired, the light may be transmitted from any azimuth, by giving rotation to the tube carrying a diaphragm with a marginal aperture.—The Webster Condenser thus improved (which may also be used in combination with the Polariscope) will be found one of the most universally-useful accessories with which a Student's Microscope can be provided.

101. *Oblique Illuminators*.—The extremely oblique illumination required for the resolution of the more difficult lined 'tests,' may be provided, as has been shown, either by the employment of a Condenser of very wide angular aperture (§ 99); or by giving to the whole Illuminating apparatus (as originally suggested by Mr. Grubb, of Dublin) a posi-

---

A form of condenser specially adapted for very oblique and also for 'black-ground' illumination was devised a few years ago by Prof. Abbe of Jena ("Monthly Microsc. Journ.," Vol. xiii., 1875, p. 77), and has since been specially adapted by him for use with 'homogeneous immersion' objectives, being fitted to the microscope-stands constructed by Zeiss; but not being found easily applicable to Microscopes of the ordinary English models, it has not been taken up by Makers of this country. It seems to the Author, however, that the *sliding-plate*, by which any degree of eccentricity can be given to the apertures that the optical combination admits of, might, in combination with the Iris-diaphragm for limiting the angle of the pencil, be advantageously substituted for the *rotating diaphragm plate*.

tion of such obliquity to the optic axis of the Microscope, that even its axial ray shall fall upon the object-slide at a very low inclination—as in the Ross-Zentmayer Microscopes (§§ 59, 72), and in the arrangements of Messrs. Beck (§ 75) and Mr. Swift (§ 68). It is considered by Mr. Wenham that there is no better method of utilizing this arrangement, than by making the Sub-stage carry an ordinary Objective of about 1-inch focus, and throwing its pencil upon a hemispherical lens of half an inch diameter, the plane side of which has a film of glycerine interposed between itself and the object-slide. The lens may either be held in this position by its own adhesion, or it may be so fitted into a thin stage, that its plain surface shall lie flush with the surface of the object-platform. This (as also the Disk-Illuminator to be next described) may be made to work well with any form of Students' Microscope, which, like Wale's (§ 60), has a thin stage and a mirror so swung as to be capable of reflecting rays of great obliquity.—For the illumination of objects by a line of light thrown upon them very obliquely, Mr. Wenham has devised the simple Illuminator shown in Fig. 76. This consists of a semi-circular *disk* of glass (somewhat resembling the half of a button) of half an inch in diameter, the sides of which are flattened, while the circular edge is rounded and well polished to a transverse radius of 1-10th of an inch. This concentrates the light thrown upon any part of its circumference, upon an object mounted on a slide of the usual thickness, with whose under side it is brought into immersion-contact by the intervention of either water, glycerine, or a more refractive oil. As it should be so fitted to the Microscope as to illuminate the objects from any azimuth, it should have its flat sides grasped in a clip, which may either be mounted on the Sub-stage, or attached to under side of the Stage—in either case having its diametric section brought up to the under surface of the object-slide. By giving rotation to the object, the illuminator remaining fixed, the illuminating beam may be made to cross the former in any direction that is fitted to bring out its markings. With this simple Illuminator, even *Amphipleura pellucida* may be resolved without the aid of a Condenser, the mirror alone sufficing.<sup>1</sup>—Another simple and effective appliance for the same purpose, is the *Woodward Prism*: a small obtuse-angled triangle of glass, whose long face must be brought into immersion-contact with the object-slide by a film of interposed glycerine. Originally devised as a right-angled prism, it was suited only for the illumination of objects seen under immersion Objectives of widest angular aperture; but by reducing its oblique angles to less than 45°, so as to open-out the two equal sides, it may be adapted to Objectives of much smaller aperture. In using it, the light is made to enter one of the oblique facets perpendicularly to its surface; and by looking in the like direction through the other side of the prism, the observer can see when the face of the object is best illuminated, by the rays reflected on it from the inner surface of that facet.—This prism can be made to hang to the under surface of the object-slide by the film of interposed glycerine; but as it is very apt to slip when the microscope is inclined, and as its full advantage can only be obtained when the object is made to rotate so as to meet the illuminating beam in



Wenham's Disk-Illuminator.

<sup>1</sup> For the mode of constructing this Illuminator, see "Journ. of Roy. Microsc. Soc.," Vol. iii. (1880), p. 246.

is so much, it should be mounted, like the Disk-illuminator just described, in an independent fitting.

The *Oblique Prism*, which causes the rays to be at once reflected from one surface and concentrated by lenticular surfaces, so as to answer the purpose of Mirror and Condenser at the same time, is much approved by those who have used it. Such a Prism may be either mounted on a sliding base, or attached to some part of the Microscope-stand. The arrangement shown in Fig. 77, is a very simple and convenient one; this

FIG. 77

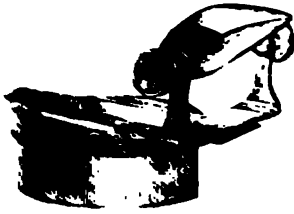

AVANCE'S PRISM.

consists in attaching the frame of the prism to a sliding bar, which works in dovetail grooves on the top of a cap that may be set on the "secondary body" beneath the stage; the slide serves to regulate the distance of the prism from the axis of the microscope, and consequently the obliquity of the illumination; whilst its distance beneath the stage is adjusted by the rack-movement of cylindrical fitting. In this manner, an illuminating pencil of almost any degree of obliquity that is permitted by the construction of the Stage may be readily obtained; but there is no pro-

vision of the correction of its aberrations. In order to use this oblique illumination to the greatest advantage, either the prism or the object may be made to rotate, thus causing the oblique rays to fall upon the object from every azimuth in succession, so as to bring out all its markings

*Oblique Illumination.*—When the rays are directed with such obliquity as not to be received into the Object-glass at all, but are merely retained by the Object to render it (so to speak) self-luminous, we have what is known as the *Oblique-pointed illumination*. For low powers, whose angular aperture is small, and for such objects as do not require any more special provision, a sufficiently good black-ground illumination may be obtained by turning the concave Mirror as far as possible out of the axis of the microscope, especially if it be so mounted as to be capable of a more than ordinary degree of obliquity. In this case it is often possible, not merely to bring into view features of a more than ordinary nature, but to distinguish, as to see bodies of various transparence (such, for instance, as very minute Animalcules) that are not visible when the field is flooded (so to speak) by direct light; to present, in short, the spectacle of phosphorescent points rapidly revolving in their axes. It is one of the great advantages of this illumination, especially as the light enters from each part of the field in a proper sense, instead of merely passing through it from a common source, as if different parts are seen much more in their normal position, and that, in fact, it affords far more of the aspect of solidity. The curvature of this is easily made apparent, by holding up a glass plate with a fluted surface in front of a lamp or a window, at some distance from the eye; so that it is seen by transmitted light alone; for the flutes, when the two surfaces are thus so placed together, that unless their position and inclination be previously known, it can scarcely be said with any accuracy, which way is going to which. If, on the other hand, an object is placed in the space, so that no rays are transmitted

directly through it, whilst it receives adequate illumination from the light around, its form is clearly discerned, and the two surfaces are distinguished without the least difficulty.

104. A simple method of obtaining 'black-ground' illumination, which works well with objectives of low power and small angular aperture, consists in fixing into the top of a short tube that slides into the 'cylindrical fitting' usually carried beneath the stage in Educational and Students' Microscopes, a small 'bull's eye' lens, the plane surface of which (placed uppermost) has its central portion covered by a black spot. When light reflected by the mirror falls on the lower surface of this *Spot-Lens*, only the rays that fall on its marginal ring are allowed to pass; and these, owing to its high curvature, are so strongly refracted inwards, as to cross each other in the object (when the lens is focussed for it), and then diverge again at an angle sufficiently wide to pass beyond the margin of the objective, like those transmitted by the Paraboloid to be pres-

FIG. 79.



FIG. 78.



Parabolic Illuminator.

ently described (Fig. 79, F G, F H). Thus the field is left dark; whilst the light stopped by the object gives it a luminosity of its own.—The same effect is gained by the use of the Webster Condenser (§ 100) with a central stop placed immediately behind the lower lens or upon the flat surface of the upper.—Neither of the foregoing plans, however, will answer well for objectives of high power, having such large angles of aperture that the light must fall *very* obliquely to pass beyond them altogether. Thus if the pencil formed by the 'spot-lens' have an angle of  $50^\circ$ , its rays will enter a 4-10ths objective of  $60^\circ$ , and the field will not be darkened.

105. A greater degree of obliquity, suited to afford 'black-ground' illumination with Objectives of larger angular aperture, may be obtained by the use of the *Parabolic Illuminator*<sup>1</sup> (Fig. 78); which consists of a

<sup>1</sup> A Parabolic Illuminator was first devised by Mr. Wenham, who, however, employed a Silver speculum for the purpose. About the same time, Mr. Shadbolt devised an Annular Condenser of Glass for the same purpose (see "Transact. of Microsc. Soc.," Ser. I, Vol. iii., 1852, pp. 85, 132). The two principles are combined in the Glass Paraboloid.



Paraboloid of glass that reflects to its focus the rays which fall upon its internal surface. A diagrammatic section of this instrument, showing the course of the rays through it, is given in Fig. 79, the shaded portion representing the Paraboloid. The parallel rays  $r, r', r''$ , entering its lower surface perpendicularly, pass on until they meet its parabolic surface, on which they fall at such an angle so as to be totally reflected by it (§ 2) and are all directed towards its focus,  $F$ . The top of the paraboloid being ground out into a spherical curve of which  $F$  is the centre, the rays in emerging from it undergo no refraction, since each falls perpendicularly upon the part of the surface through which it passes. A stop placed at  $s$  prevents any of the rays reflected upwards by the mirror from passing to the object, which, being placed at  $F$ , is illuminated by the rays reflected into it from all sides of the Paraboloid. Those rays which pass through it diverge again at various angles; and if the least of these,  $G F H$ , be greater than the angle of aperture of the Object-glass, none of them can enter it. The stop  $s$ , is attached to a stem of wire, which passes vertically through the Paraboloid and terminates in a knob beneath, as shown in Fig. 78; and by means of this it may be pushed upwards so as to cut off the less divergent rays in their passage towards the object, thus giving a black-ground illumination with Objectives of an angle of aperture much wider than  $G F H$ .—In using the Paraboloid for delicate objects, the rays which are made to enter it should be parallel, consequently the *plane* Mirror should always be employed; and when, instead of the parallel rays of daylight, we are obliged to use the diverging rays of a lamp, these should be rendered as parallel as possible, previously to their reflection from the mirror, by the interposition of the 'bull's eye' Condenser (Fig. 87) so adjusted as to produce this effect. There are many cases, however, in which the stronger light of the *concave* Mirror is preferable.—When it is desired that the light should fall on the object from one side only, the circular opening at the bottom of the wide tube (Fig. 78) that carries the Paraboloid, may be fitted with a diaphragm adapted to cover all but a certain portion of it; and by giving rotation to this diaphragm, rays of great obliquity may be made to fall upon the object from every azimuth in succession.<sup>1</sup>—A small glass cone, with the apex downwards, and the base somewhat convex, with a stop in the centre, is fitted by MM. Nacet to their Microscopes for the same purpose; and performs very effectively.

106. In order to adapt the Paraboloid for black-ground illumination under Objectives of wide angle of aperture, Mr. Wenham<sup>2</sup> long since constructed a *flat-topped* paraboloid, fitted to reflect only rays of such extreme obliquity, that they would not pass out of the flat surface of the paraboloid into the under surface of the slide, unless a film of either water or of some liquid of higher refractive index (such as turpentine, or oil of cloves) was interposed between them. When thus enabled to enter the slide, these rays pass on until they meet the cover, from which (in the case of dry-front objectives) they are reflected downwards upon the surface of the object, giving it a bright illumination on a perfectly dark field. The special value of this instrument, however, not being then understood, it was not constructed for sale.—The same prin-

<sup>1</sup> By the use of such a diaphragm, or of a large stop with an eccentric perforation, Mr. G. Williams has succeeded in resolving the transverse striae of *Amphipleura pellucida* with water-immersion Objectives. See "Journ. of Roy. Microsc. Soc.," Vol. iii. (1880), p. 524.

<sup>2</sup> "Transact. of Microsc. Soc.," N. S., Vol. iv. (1856), p. 59.

iple, however, having been more recently taken up by Dr. Edmunds, an Immersion Paraboloid specially devised by him for use with immersion Objectives of large aperture, has been constructed by Messrs. Powell & Lealand, with results so satisfactory, that it now ranks among the Accessories most valued by such as habitually work with Objectives of that highest class.<sup>1</sup>

107. *Wenham's Reflex Illuminator*.—Another very ingenious and valuable illuminator for high powers has been devised by Mr. Wenham,<sup>2</sup> and constructed by Messrs. Ross. It is composed of a glass cylinder (Fig. 80, *a*) half-an-inch long, and four-tenths of an inch in diameter; one side of which, starting from the bottom edge, is worked to a polished face at an angle of  $64^\circ$  with the base. The top of the cylinder is polished flat, whilst its lower surface is convex, being polished to a radius of 4-10ths of an inch; close beneath this last is set a plano-convex lens of  $1\frac{1}{4}$  inch focus; and the combination is set eccentrically in a fitting, *i i*, adapted to be received into the Sub-stage. The parallel rays, *f f f*, reflected up into it from the mirror, are made to converge, by the convex surfaces at the base of the cylinder, at such an angle, that if their course were continued through glass they would meet at the point *h*, above the glass slide *c*; but by impinging on the inclined polished surface, they are reflected to the flat segmental top, from which again they would be reflected obliquely downwards so as to meet in the point

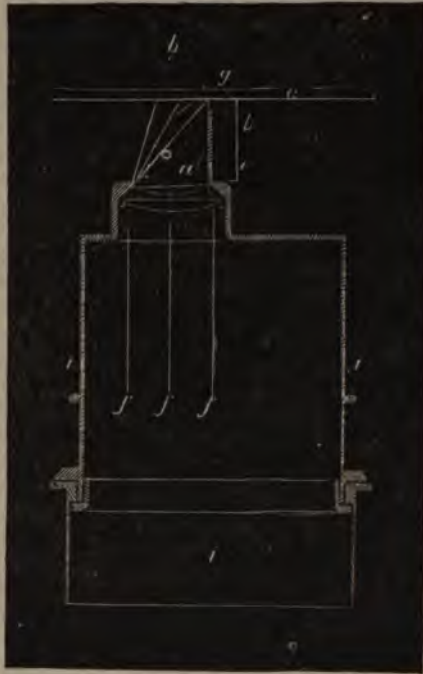

Wenham's Reflex Illuminator.

*b*, but for its being brought into 'immersion-contact' with the under side of the slide. Passing upwards through the slide, they meet in a point, *g*, a little above its upper surface, in the optic axis of the Microscope, to which point the object must be brought; and by giving rotation either to the object or to the illuminator, it may be illumined from every azimuth. For convenience of centering, a black half-cylinder *e*, is so fixed by the side of the cylinder, that if a dot upon its upper surface be brought into the centre of the field of view of a low-power objective, its focus *g*, will lie in the optic axis.—Some skill and practice are required to use this apparatus to advantage, but it will amply repay the trouble of mastering its difficulties. It is best suited to thin flat objects; with those that are thick and irregular, distortion is unavoidable.

<sup>1</sup> "Monthly Journ. of Microsc. Sci.," Vol. xviii., p. 78.

<sup>2</sup> *Ibid.*, Vol. vii., p. 239.



Although specially designed as a 'black-ground' illuminator, it may also be made useful in the resolution of difficult Test-objects by *transmitted* light,<sup>1</sup> the illuminator being lowered until a colored spectrum appears in the field, the rays of which bring out their markings with remarkable distinctness.—For use with either of these arrangements for 'black-ground' illumination, it is better that the objects should be mounted 'dry,' especially when they are to be viewed under 'immersion' objectives; balsam-mounted objects being thus seen better with dry-front objectives.

108. The following directions are given by Mr. Schulze ("English Mechanic," 1877, No. 661) for the use of two illuminators last described:—"First, rack up the Sub-stage, until the plane top of the illuminator is level with the stage; centre carefully; put a drop or two of glycerine on the under side of the slide, taking care that no air-bells are formed; and place the slide on the stage. If, now, rays parallel to the optic axis are thrown up by the plane mirror or rectangular prism, a luminous spot will appear on the slide if an object lies in the optic axis. Next focus; and by adjusting the mirror or rectangular prism more carefully, the object will be brilliantly illuminated by very oblique rays on a black ground. . . . I generally use one of How's common Microscope lamps filled with good paraffin oil, and having a wick half an inch broad; but for the highest powers I have recourse to the Dallinger lamp (§ 131). After I have obtained the best results, I interpolate a bull's-eye Condenser to increase the light, focussing carefully a miniature image of the flame on the slide. I invariably use the narrow side of the flame turned towards the mirror or prism, when resolving lined tests. It is, however, by sunlight that the performances of the Immersion Paraboloid and Reflex Illuminator seem to eclipse any resolution that can be obtained by transmitted light." [This was written *before* Mr. Schulze had found out the mode of working these instruments already noticed.] In regard to the relative values of the two illuminators, Mr. Schulze states as the result of careful comparative trials of them:—"The Paraboloid is a trifle easier managed, gives a little more light by lamplight, and is somewhat cheaper than the Reflex Illuminator. Both perform equally well on dark ground by sunlight; but the Reflex Illuminator can also be used on balsamed slides and with immersion lenses for the examination of objects by transmitted very oblique white light."

109. *Light-Modifiers*.—For (1) reducing the intensity either of Solar-light or Lamp-light, (2) for correcting the yellowness of the latter, and (3) for the equable diffusion of either light over a large field, it is often convenient to employ interposed media, the nature of which must be varied according to the particular purpose to be attained.—The direct rays of the Sun are very little employed by Microscopists, except for Photography or some other special purpose. But when recourse is had to them in ordinary Microscopy, it is well to take advantage of 'Rainey's Light-modifier,' which is a combination of one thickness of dark-blue glass free from any tint of red, another of very pale blue with a slight shade of green, and two of thick white plate-glass, all cemented together by Canada balsam. This is mounted by Messrs. Powell and Lealand on a separate stand; and may be used with Lamp-light as with sunlight.—Some observers use Lamp-chimneys of either neutral-tint or bluish glass

<sup>1</sup> See Schulze in "Journ. Roy. Microsc. Soc.," Vol. i. (1878), p. 45; and Col. Dr. Woodward in same Vol., p. 248.

for the purpose of moderating the glare of the flame or of correcting its yellowness; but as the chimney cannot be conveniently changed whenever the full light is required, the Author much prefers making such 'light-modifiers' a part of the Illuminating apparatus attached to the Microscope itself: and this may be done in different modes, according to the construction of the instrument. Thus, when the Webster Condenser (§ 100) is in use, it may be furnished with three caps made to slide upon its upper portion; one of them fitted with a disk of blue-glass, second with one of neutral-tint glass, and the third with a finely-ground glass. And in Swift's Combination Sub-stage (§ 112) similar disks may be made to drop into the openings of the rotating plate; so that one may readily be changed for another, or, if all three be placed in the plate at once, an object may be examined under any one of them by merely rotating the plate. Every ordinary Diaphragm-plate (§ 98) ought to have its largest aperture fitted, by means of a projecting shoulder, to carry such a set of disks.—The three arms on which the rotating Selenites are attached to the Sub-stage of Messrs. Beck's First-class Microscope (Fig. 82), may be fitted with similar disks, each of which may then be used either separately or in combination with one or both of the others.—Every 'Light-modifier' should be so constructed and worked, that the light should be made as nearly as possible to resemble that of a bright white cloud. For this purpose a white-cloud Reflector may be easily made—either flat, by casting a Plaster of Paris disk upon the plane surface of the mirror—or concave, by casting it on the surface of a glass globe; the light reflected from the surface of the plaster requiring to be condensed for the illumination of small objects.—Very pleasant white-cloud effects may be obtained by methods adopted by Mr. Slack. For large objects, viewed with powers of  $1\frac{1}{2}$  to 4 inches, he places under the stage a tube holding a large disk ( $1\frac{1}{2}$  inch diameter) of ground glass, the ground surface being protected by a plain glass cover over it. By this means the peculiar tint of the freshly ground surface is permanently retained. For 2-3ds and half-inch powers he employs a glass slide carrying a disk or square of thin paper, saturated with spermaceti, and protected from dirt by a thin glass cover that adheres to it. This slide, disk downwards, is placed under the object. Under still higher powers, some objects may be very conveniently illuminated by a small bull's-eye finely ground on its flat surface, and fixed with its convex face downwards in a tube that slides into the Sub-stage fitting.

110. *Polarizing Apparatus.*—In order to examine transparent objects by Polarized Light, it is necessary to employ some means of *polarizing* the rays before they pass through the object, and to apply to them, in some part of their course between the object and the eye, an *analyzing* medium. These two requirements may be provided for in different modes. The *polarizer* may be either a bundle of plates of thin glass, used in place of the mirror, and polarizing the rays by reflection; or it may be a 'single image' or 'Nicol' prism of Iceland Spar, which is so constructed as to transmit only one of the two rays into which a beam of ordinary light is made to divaricate by passing through this substance. Of these two methods, the 'Nicol' prism is the one generally preferred, the objection to the reflecting polarizer being that it cannot be made to rotate. This polarizing prism is usually fixed in a tube (Fig. 81, A, a), furnished with a large milled-head, c, at the bottom, by which it is made to rotate in a collar, b, that screws into the Sub-stage fitting. For the *analyzer* a second 'Nicol' prism is usually employed; and this, fixed in a



is fitted either into a collar interposed between the Objective and the Objective, or into a cap placed over the Objective in the stead of the ordinary eye-piece cap. The latter is specially adapted for use with the Binocular, and has the advantage of not limiting the field, but it stops a

FIG. 81.



B. Fitting of Analyzing Prism above Eye-piece.

good deal of light; while in the latter, the image is brighter, but a good deal of the margin of the field is cut off. In the Harley Binocular (§ 68) the analyzing prism is fitted into a slide below the Wenham prism, which is drawn out when the polariscope is not in use; while in Swift's Challenge Binocular, a similar slide is fitted into the body above

the objective. In these arrangements, such advantage as is obtainable from the use of the analyzing prism is of course foregone; and the same may be made, when, in the Stephenson Binocular (§ 36), the Iceland prism is replaced by a reflector.—The Polarizing apparatus may be used in conjunction either with the Achromatic Condenser (by which it may be used with high power Objectives), or with either of the two kinds of Illuminators (§§ 104, 105), which show many objects—especially many polyparies of Zoophytes—gorgeously projected in colors in the field.

By bringing out certain effects of Color by the use of Polarized Light (Chap. XVII.), it is desirable to interpose a plate of *Selenite* between the polarizer and the object; and it is advantageous that this plate should be made to revolve. A very convenient mode of effecting this, is to fit the *Selenite* plate in a revolving collar, which fits into the end of the tube that receives the Polarizing prism. In order to obtain the greatest variety of coloration with different objects, films of *Selenite* of different thickness should be employed; and this may be accomplished by substituting one for another in the revolving collar. A still greater variety may be obtained by mounting three films, which respectively give three different colors, in collars revolving in a frame revolving that in which hand-magnifiers are usually mounted; this frame being carried into the Sub-stage in such a manner, that either a single *Selenite*, or any combination of two *Selenites*, or all three together, may be brought into the optic axis above the polarizing prism (Fig. 82). As many as thirteen different tints may thus be obtained.—When the connection of the Microscope does not readily admit of the connection of the *Selenite* plate with the Polarizing prism, it is convenient to make use of a plate of brass (Fig. 83) somewhat larger than the glass slides in which objects are ordinarily mounted, with a ledge near one edge for the slide to rest against, and a large circular aperture into which a glass is fitted, having a film of *Selenite* cemented to it; this 'Selenite stage' or object-carrier being laid upon the Stage of the Microscope, the slide containing the object to be placed upon it; and, by an ingenious modification contrived by Dr. Latham, the ring into which the *Selenite* plate is fitted being made movable, one plate may be substituted for another, whilst rotation may

be given to the ring by means of a tangent-screw fitted into the brass-plate.—The variety of tints given by a Selenite-film under Polarized light, is so greatly increased by the interposition of a rotating film of Mica, that two Selenites—*red* and *blue*—with a Mica-film, are found to give the entire series of colors obtainable from any number of Selenite-films, either separately or in combination with each other. The *Revolv-*

FIG. 82.

Darker's Selenites, as fitted by  
Messrs. Beck.

FIG. 83.



Selenite Object-carrier.

ing *Mica-Selenite Stage* (Fig. 84) devised by Mr. Blankly, and made by Mr. Swift, furnishes a very simple and effective means of obtaining these beautiful effects; the Mica film being set in a diaphragm which can be made to rotate by applying the finger at the front edge of the stage; whilst the two Selenites are so placed in a slide, that either of them can be brought under the aperture as desired.

FIG. 84.



Blankly's Revolving Mica-Selenite Stage.

112. *Swift's Combination Sub-stage*.—In this ingenious piece of apparatus (Fig. 85) are combined the advantages of (1) an Achromatic Condenser, *A*, centred by two milled-headed screws, *c c*, and having an angle of  $140^\circ$ , which fits it for use with Objectives of very wide angular aperture, whilst, by removing the upper combination, it is made to suit lower powers; (2) a contracting Diaphragm worked by the lever *B*; (3) a revolving Diaphragm, *E*, with four apertures, into which can be fitted either (*a*) a series of three central stops, giving a Black-ground illumination scarcely inferior to that of the paraboloid, and capable of being used with the small angled 1-5th, (*b*) tinted or ground-glass Moderators, or (*c*) two Selenite-films for the Polarizing apparatus; (4) a Polarizing prism, *F*, mounted on an eccentric arm, so as to be brought under the axis of the condenser when not in use, and thrown out when not wanted; and

(5) an upper arm carrying two revolving cells geared together by fine teeth (one of them shown at D, while the other is under the condenser), so that a revolving motion may be given to either by acting on the other; one of these cells carries a plate of Mica, the revolution of which over the

FIG. 85.

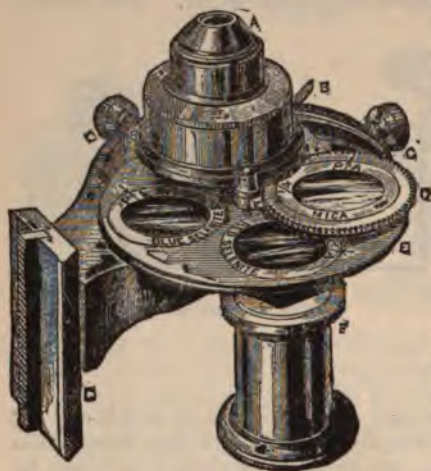

Swift's Combination Sub-stage.

selenite-films gives a great variety of color-tints with Polarized light; while the other serves to receive oblique-light disks, to which rotation can be given by the same means.—The special advantage of this Condenser lies in its having the polarizing prism, the selenite- and mica-films, the black-ground and oblique-light stops, and the moderator, all brought close under the back lens of the Achromatic; whilst it combines in itself all the most important appliances which the Sub-stage of Secondary body of First-class Microscopes is able to afford. It may be specially recommended to such as make much use of Polarized light.

113. *Illuminators for Opaque Objects.*—All objects through which sufficient light cannot be transmitted to enable them to be viewed in the modes already described, require to be illuminated by rays, which, being thrown upon the surface under examination, shall be reflected from it into the Microscope; and this mode of viewing them may often be advantageously adopted in regard to semi-transparent or even transparent objects, for the sake of the diverse aspects it affords. Among the various

methods devised for this purpose, the one most generally adopted consists in the use of a *Condensing Lens* (Fig. 86), either attached to the Microscope, or mounted upon a separate stand, by which the rays proceeding from a lamp or from a bright sky are made to converge upon the object.—For the efficient illumination of large opaque objects, however, it is desirable to employ a *Bull's eye* Condenser (which is a plano-convex lens of short focus, two or three inches in diameter), mounted upon a separate stand, in such a manner as to allow of being placed in a great variety of positions. The mounting shown in Fig. 87, is one of the best that can be adopted: the frame which carries the lens is borne at the bottom upon a swivel joint, which allows it to be turned in any azimuth; whilst it may be inclined at any angle to the horizon, by the revolution of the horizontal tube to which it is attached, around the other horizontal tube which projects from the stem; by the sliding of one of these tubes within the other, again, the horizontal arm may be lengthened or shortened; the lens may be secured in any position (as its weight is apt to drag



it down when it is inclined, unless the tubes may be made to work, the one into the other, more stiffly than is convenient) by means of a tightening collar milled at its edges; and finally the horizontal arm is attached to a sprung socket, which slides up and down upon a vertical stem. The optical effect of such a 'bull's-eye' differs according to the side of it turned towards the light, and the condition of the rays which fall upon it. The position of *least* spherical aberration is when its *convex* side is turned towards *parallel* or towards the *least diverging* rays: consequently, when used by Daylight, its *plane* surface should be turned towards the *object*; and the same position should be given to it when it is used for procuring converging rays from a lamp, this being placed four or five times farther



off on one side than the object is on the other. But it may also be employed for the purpose of reducing the diverging rays of the Lamp to parallelism, for use either with the Paraboloid (§ 105) or with the Parabolic speculum to be presently described; and the *plane* side is then to be turned towards the lamp, which must be placed at such a distance from the 'bull's-eye,' that the rays which have passed through the latter shall form a luminous circle equal to it in size, at whatever distance from the lens the screen may be held. For viewing minute objects, under high powers, the smaller Condensing lens may be used to obtain a further concentration of the rays already brought into convergence by the 'bull's-eye.'—An ingenious and effective mode of using the 'bull's-eye' condenser, for the illumination of very minute objects under high-power





but a much stronger light may be concentrated on it, when the Speculum receives its rays from a lamp placed near the opposite side of the stage, a 'bull's-eye' being interposed to give parallelism to the rays. For the sake of Microscopists who may desire to use this admirable instrument with Objectives to which it has not been specially fitted, an adapter is made by Mr. Crouch, consisting of a collar (Fig. 89, A) interposed between the lower end of the body of the Microscope and the objective; on this is fitted the ring B, which turns easily round it, and carries the horizontal arm C C, jointed at each end; whilst the stem D, which can be lengthened or shortened at pleasure, hanging from this, carries at its lower end the Speculum F attached to it by the ball-and-socket joint E. By this arrangement the Parabolic Speculum may be used not only with the objectives already named, but also with those of one-half or 4-10ths inch focus, if these do not approach the object so nearly as to interfere with the reflection of the illuminating rays from the Speculum.

115. *Lieberkühn*.—A mode of illuminating opaque objects by a small concave Speculum reflecting directly down upon them the light reflected



Diagram of Lieberkühn

up to it from the Mirror, was formerly much in use, but is now comparatively seldom employed. This concave Speculum, termed a 'Lieberkühn' from the celebrated Microscopist who invented it, is made to fit upon the end of the Objective, having a perforation in its centre for the passage of the rays from the object to the lens; and in order that it may receive its light from a mirror beneath (Fig. 90, A), the object must be so mounted as only to stop-out the central portion of the rays that are reflected upwards. The curvature of the Speculum is so adapted to the focus of the Objective, that, when the latter is duly adjusted, the rays reflected up to it from the mirror shall be made to converge strongly upon the part of the object that is in focus: a separate speculum is consequently required for every objective. The disadvantages of this mode of illumination are chiefly these:—first, that by sending the light down upon the object almost perpendicularly, there is scarcely any shadow, so that the inequalities of its surface and any minute markings which it might present, are but faintly or not at all seen; second, that the size of the ob-

ject must be limited by that of the speculum, so as to allow the rays to pass to its marginal portion; and third, that a special mode of mounting is required, to allow the light to be reflected from the mirror around the margin of the object. The first objection may be in some degree removed by turning the mirror considerably out of the axis, so as to reflect its light obliquely upon the Lieberkühn, which will then send it down obliquely upon the object (Fig. 90, B); or by covering one side of the Lieberkühn by a diaphragm, which should be made capable of rotation, so that light may be reflected from the uncovered portion in every azimuth: the illumination, however, will in neither case be so good as that which is afforded with powers up to 2-3ds inch, by the Parabolic Speculum just described. The mounting of Opaque objects in wooden slides (Fig. 124), which affords in many cases the most convenient means of preserving them, completely prevents the employment of the Lieberkühn in the examination of them; and they must be set for this purpose either upon disks which afford them no protection, or in cells (§ 169) with a blackened background. The cases wherein the Lieberkühn is most useful, are those in which it is desired to examine small opaque objects, such as can be held in the Stage-Forceps (§ 118) or mounted on small disks (§ 119), or laid upon a slip of glass, with objectives of *half-inch* focus or less; since a stronger light can be thus concentrated upon them, than can be easily obtained by side-illumination. In every such case, a black background must be provided, of such a size as to fill the field, so that no light shall come to the eye direct from the mirror, and yet not large enough to create any unnecessary obstruction to the passage of the rays from the mirror to the speculum. With each Lieberkühn is commonly provided a blackened stop of appropriate size, having a well-like cavity, and mounted upon a pin which fits into a support connected with the under side of the stage; but though this 'dark well' serves to throw out a few objects with peculiar force, yet, for all ordinary purposes, a spot of black paper or black varnish will answer the required purpose very effectually, this spot being either made on the under side of the cell which contains the object, or upon a separate slip of glass laid upon the stage beneath this.

116. *Vertical Illumination for High Powers.*—Various attempts have been made by Mr. Wenham and others to view opaque objects under powers too high for the advantageous use of the Lieberkühn, by employing the Objective itself as the illuminator, light being transmitted into it downwards from above. By Prof. H. L. Smith, of Geneva College, U. S., a pencil of light admitted from a lateral aperture above the objective, was reflected downwards upon the object through its lenses, by means of a small silver speculum placed on one side of its axis and cutting off a portion of its aperture. By Messrs. Powell and Lealand, a piece of plane glass was placed at an angle of  $45^\circ$  across a tube placed like an adapter between the Objective and the body of the Microscope; and whilst a pencil of light, entering at the side aperture and striking against this inclined surface, is reflected by it downwards through the objective on to the object, the rays proceeding upwards from the object pass upwards (with some loss by reflection) through the plane glass into the body of the Microscope. For this fixed plate of glass, Mr. R. Beck substituted a disk of thin glass attached to a milled-head (Fig. 91, B), by the rotation of which its angle may be exactly adjusted; and this is introduced by a slot (shown at *e*, Fig. 91, A) into the interior of an adapter that is interposed between the objective (*c*, *d*) and the nose (*e*) of the Microscope.



The light which enters at the lateral aperture (A, *a*) falling upon the oblique surface of the disk (C, *b*), is reflected downwards, and is concentrated by the lenses of the Objective upon the object beneath. The lateral aperture may be provided with a diaphragm, having a series of apertures, for diminishing the false light to which this method is liable; or a screen with a small aperture may be placed at any distance between the lamp and the Illuminator, that is found to produce the best effects. In using this illuminator, the lamp should be placed at a distance of about 8 inches from the aperture; and when the proper adjustments have been made, the image of the flame should be seen upon the object. The illumination of the entire field, or the direction of the light more or less to either side of it, can easily be managed by the interposition of a small Condensing lens placed at about the distance of its own focus from the lamp. The Objects viewed by this mode of illumination with dry-front objectives, are best uncovered; since, if they are covered with thin glass, so large a proportion of the light sent down upon them is reflected from the cover (especially when Objectives of large angle of aperture

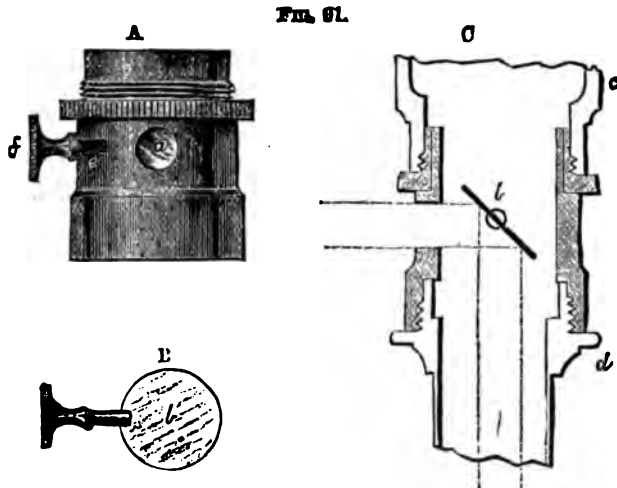

Beck's Vertical Illuminator.

are employed) that very little is seen of the objects beneath, unless their reflective power is very high. With immersion objectives, however, covered objects may be used; and the author has seen a more perfect resolution of difficult tests by this mode of viewing them (first suggested by Mr. Morehouse, of Wayland, New York) than by any other.<sup>1</sup>—Another method of Vertical Illumination long since devised by Mr. Tolles has recently been brought into notice by Prof. W. A. Rogers, of Boston, U. S. It consists in the introduction of a small rectangular prism, resembling that of Nacet's Binocular (A, Fig. 27), at a short distance behind the front combination of the Objective; so that parallel rays entering its vertical end-surface, pass on between the parallel horizontal surfaces, until they meet the inclined surface by which they are reflected downwards. In passing through the front combination of the objective,

<sup>1</sup> "Journ. of Roy. Microsc. Soc.," Vol. ii. (1879), pp. 194, 266.



may be directed towards its axis; but as their angle of convergence is increased, the angle of divergence of the rays proceeding from the object, and the rays will not meet in the focal point of the lens, but will be so refracted as to illuminate a sufficient area. By altering the extent of the prism's rotation, or by lifting or depressing its outer end by means of a milled-head screw, the field of illumination may be regulated. The working of this prism with immersion objectives is stated by Mr. Tolles to be peculiarly satisfactory.

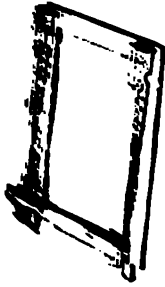

117. *Stephenson's Safety Stage.*—In examining objects with those higher powers which focus extremely close to the covering glass, the slightest inadvertence is likely to lead to a fracture of the glass, and perhaps to the destruction of a valuable slide. This is a serious matter with Möller's Diatom Type Slide, or Nobert's Test Lines, or with many others that are expensive or perhaps impossible to replace. To remove this source of danger, Mr. Stephenson contrived the "safety stage," shown in Fig. 92. The frame on which the slide carrying the object rests, is hinged at its upper part, and kept in its true position by slight springs, which give way exactly the slide is pressed by the objective. It is found that springs strong enough to insure the steadiness required for high powers, may yet be sufficiently flexible to give way before very thin glass is endangered, and a glance at the stage shows if it is made to deviate from the normal position in which its upper and lower edges are parallel.—(See also § 115.)

Section 3. *Apparatus for the Presentation of Objects.*

118. *Stage Forceps and Vice.*—For bringing under the Object-glass in different positions such small opaque objects as can be conveniently held on a pair of forceps, the *Stage-Forceps* (Fig. 93) supplied with most



Microscopes afford a ready means. These are mounted by means of a joint upon a pin, which fits into a hole either in the corner of the Stage itself or in the object-platform; the object is inserted by pressing the pin that projects from one of the blades, whereby it is separated from the other, and the blades close again by their own elasticity, so as to retain the object when the pressure is withdrawn. By sliding the wire stem which bears the Forceps through its socket, and by moving that socket vertically upon its joint, and the joint horizontally upon the pin, the object may be brought into the field precisely in the position required; and it may be turned round and round, so that all sides of it may be examined, by simply giving a twisting movement to the wire stem. The upper extremity of the stem often bears a small brass box filled with cork, and perforated with holes in its sides; this affords a secure hold to common pins, to the heads of which small objects can be attached by means of which disks of card, etc., may be attached, whereon objects are mounted for being viewed with the Lieberkühn (§ 115). This

method of mounting was formerly much in vogue, but has been less employed of late, since the Lieberkühn has fallen into comparative disuse.—The *Stage Vice*, as made by Mr. Ross for Mr. Slack, was contrived for the purpose of holding small hard bodies, such as Minerals, apt to be jerked out by the angular motion of the blades of the forceps, or very delicate substances that will not bear rough compression. In this apparatus the blades meet horizontally, and their movements can be regulated to a nicety with a fine screw. The *Stage Vice* fits into a plate, as is the case with Beck's disk-holder, Fig. 94.

119. For the examination of objects which cannot be conveniently held in the stage-forceps, but which can be temporarily or permanently attached to disks, no means is comparable to the *Disk-holder* of Mr. R. Beck (Fig. 94) in regard to the facility it affords for presenting them in every variety of position. The object being attached by gum (having a small quantity of glycerine mixed with it) or by gold-size, to the surface of a small blackened metallic Disk, this is fitted by a short stem projecting from its under surface into a cylindrical holder; and the holder carrying the disk can be made to rotate around a vertical axis by turning the milled-head on the right, which acts on it by means of a small chain that works through the horizontal tubular stem; whilst it can be made to incline to one side or to the other, until its plane becomes vertical, by turning the whole movement on the horizontal axis of its cylindrical socket.<sup>1</sup> The supporting plate being perforated by a large aperture, the object may be illuminated by the Lieberkühn if desired. The disks are inserted into the holder, or are removed from it, by a pair of Forceps constructed for the purpose; and they may be safely put away, by inserting their stems



Beck's Disk-holder.

into a plate perforated with holes. Several such plates, with intervening guards to prevent them from coming into too close apposition, may be packed into a small box. To the value of this little piece of apparatus the Author can bear the strongest testimony from his own experience, having found his study of the *Foraminifera* greatly facilitated by it.—A less costly substitute, however, which answers sufficiently well for general purposes, is found in the *Object-holder* of Mr. Morris (Fig. 95), which consists of a supporting plate that carries a ball-and-socket joint in its centre, into the ball of which can be fitted by a tapering stem either a holder for small cardboard disks, or a larger holder suitable for carrying an ordinary slide. By the free play of the ball-and-socket joint in different directions, the object may either be made to rotate, or may be so tilted as to be viewed obliquely or almost laterally. This instrument can, of course, be used only by side illumination; and in order to turn it to the best account, the objects to be viewed by it must be mounted on special disks; but it has an advantage over the preceding, in being applicable also to objects mounted in ordinary slides.—The same purpose is answered, in the Ross Zentmayer Microscopes (§§ 59, 72), and in the Improved Beck Microscope (§ 65), by turning the stage round its *horizontal axis*, so that an object mounted on a slide may be

<sup>1</sup> A small pair of Forceps adapted to take up minute objects may be fitted into the cylindrical holder, in place of a disk.

viewed at any desired angle or inclination, when it has been brought into the most suitable azimuth by the rotating of the stage round its *vertical* axis.

120. *Glass Stage-plate*.—Every microscope should be furnished with a piece of Plate-glass, about 4 in. by  $1\frac{1}{2}$  in., to one margin of which a narrow strip of glass is cemented, so as to form a ledge. This is extremely useful, both for laying objects upon (the ledge preventing them—together with their covers, if used—from sliding down when the Microscope is inclined), and for preserving the stage from injury by the spill-

FIG. 95.



Morris's Object-holder.

ing of sea-water or other saline or corrosive liquids, when such are in use. Such a plate not only serves for the examination of transparent, but also of opaque objects; for if the Condensing-lens be so adjusted as to throw a side-light upon an object laid upon it, either the Diaphragm-plate or a slip of black-paper will afford a dark back-ground; whilst objects mounted on the small black disks suitable to the Lieberkühn may conveniently rest on it, instead of being held in the Stage-forceps.

121. *Growing Slide*.—A number of contrivances have been devised of late years, for the purpose of watching the life-histories of minute aquatic organisms, and of 'cultivating' such as develop and multiply themselves in particular fluids. One of the simplest and most effective, that of Mr. Botterill, represented in Fig. 96,—consists of a slip of ebonite, three inches by one, with a central aperture of  $\frac{3}{4}$  of an inch at its under side; this aperture is reduced by a projecting shoulder, whereon is ce-

FIG. 96.



Botterill's Growing-Slide.

mented a disk of thin glass, which thus forms the bottom of a cell hollowed in the thickness of the ebonite slide. On each side of this central cell, a small lateral cell communicating with it and about  $\frac{1}{4}$  inch in diameter, is drilled-out to the same depth; this serves for the reception of a supply of water or other fluid, which is imparted, as required, to the



central 'growing' cell, which is completed by placing a thin-glass cover over the objects introduced into it, with the interposition of a ring of thin paper, or (if a greater thickness be required) of a ring of cardboard or vulcanite. If the fluid be introduced into one of the lateral cells, and be drawn-off from the others—either by the use, from time to time, of the small glass syringe to be hereafter described (§ 127), or by threads so arranged as to produce a continuous drip *into* one and *from* the other—a constantly renewed supply is furnished to the central cell, which it enters on one side, and leaves on the other, by capillary attraction.<sup>1</sup>—*Dr. Maddox's Growing-Slide* will be understood from the annexed sketch.



Maddox's Growing-Slide.

The shaded parts are pieces of tinfoil fastened with shellac glue to a glass slide. The minute fungi or spores to be grown are placed on a glass cover large enough to cover the tinfoil, with a droplet of the fluid required. This, after examination to see that no extraneous matter is introduced, is placed over the tinfoil, and the edges fastened with wax softened with oil, leaving free the spaces x x for entrance of air. Growing-slides of this description could be made cheaply with thin glass instead of tinfoil.<sup>2</sup>—For an account of a more elaborate apparatus devised by Messrs. Dallinger and Drysdale for the prosecution of their admirable researches hereafter to be noticed (Chap. XI.), the reader is referred to the description and figures given by them in the "Monthly Microscopical Journal," Vol. xi., 1874, p. 97.

122. *Aquatic Box*.—The Live-Box or Animalcule-cage (Fig. 98, A) consists of a short piece of wide brass tube, fixed perpendicular into an aperture of its own diameter in a flat-plate of brass, and closed-in at its top by the object-tablet, a disk of glass with bevelled edges (B); over this box there slides a cover, consisting of another piece of brass tube having a disk of thin glass fixed into its top. The cover being taken off, a drop of the liquid to be examined, or any thin object which can be most advantageously looked-at in fluid, is placed upon the lower plate; the cover is then slipped over it, and is pressed down until the drop of liquid be spread out, or the object be flattened, to the degree most convenient for observation. If the glass disk which forms the lid be cemented or burnished into the brass ring which carries it, a small hole should be left for the escape of air or superfluous fluid; and this may be

<sup>1</sup> For descriptions of other forms of Growing-Slide, see "Transact. of Microsc. Society," Vol. xiv., N.S., p. 34, and "Quart. Journal of Microsc. Science," N.S., Vol. vii., p. 11.

<sup>2</sup> See his paper on Cultivation of Microscopic Fungi, in "Monthly Microscopical Journ.," Vol. iii. (1870), p. 14.—Dr. Maddox recommends the following fluid as sufficiently hygrometric to keep the spores moist, and as adapted to Fungoid growths:—

Dextrine . . . . .	2 grains.
Phosphate of Soda and Ammonia . . . . .	2 "
Saturated Solution of Acetate Potash . . . . .	12 drops.
Grape Sugar . . . . .	16 grains.
Freshly distilled water . . . . .	1 oz.

The water is to be boiled in a large test-tube or beaker for 15 minutes, and covered whilst boiling and cooling; when settled, it should be poured into perfectly clean 2-drachm stoppered bottles, and kept for use.



closed up with a morsel of wax, if it be desired to prevent the included fluid from evaporating. But as it is desirable that the cover-glass should be thin enough to allow a 1-4th or a 1-6th inch Objective to be employed, and as such thin glass is extremely apt to be broken, it is a much better plan to furnish the brass cover with a screw-cap, which holds the glass disk with sufficient firmness, but permits it to be readily replaced. It is

FIG. 98.

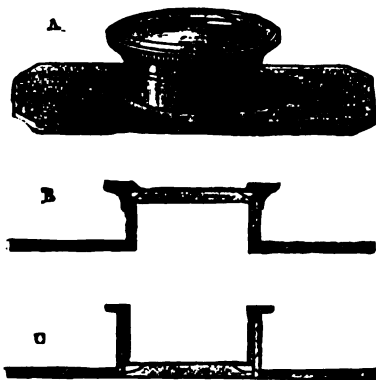

Aquatic Box or Animalcule-Cage, as seen in perspective at A, and in section at B and C.

always desirable, if possible, to prevent the liquid from spreading to the edge of the disk, since any objects it may contain are very apt in such a case to be lost under the opaque ring of the cover: this is to be avoided by limiting the quantity of liquid introduced, by laying it upon the centre of the lower plate, and by pressing down the cover with great caution, so as to flatten the drop equally on all sides, stopping short when it is spreading too close to the margin. If the Live-box be well constructed, and the glass disks be quite flat, they will come into such close contact, that objects of extreme thinness may be compressed between them; and it may thus be made, with a little practice, to serve the purpose of a Compressor (§ 125).

In its ordinary form, however, the elevation of the object-tablet above the stage prevents the Live-box from being used with the Achromatic Condenser or Paraboloid: but another form is made by Mr. Swift, in which the object-tablet is fixed at the bottom of the tube, flush with the surface of the plate (as shown at C); and as the covering disk is fixed to the bottom of the cover-tube, and thus slides *inside* the box-tube, the object can be illuminated by any of the means applicable to objects contained in ordinary flat cells (§ 123). The only disadvantage of this construction is that the cover-disk must be *fixed* in the tube which carries it.

123. Infusoria, minute Algæ, etc., however, can be well seen by placing a drop of the water containing them on an ordinary slide, and laying a thin piece of covering-glass on the top. And objects of somewhat greater thickness can be examined by placing a loop or ring of fine cotton-thread upon an ordinary slide, to keep the covering-glass a small distance from it; and the object to be examined being placed on the slide with a drop of water, the covering-glass is gently pressed down till it touches the ring. Still thicker objects may be viewed in the various forms of 'cells' hereafter to be described (§§ 171-3); and as, when the cells are filled with fluid, their glass covers will adhere by capillary attraction, provided the superfluous moisture that surrounds their edges be removed by blotting-paper, they will remain in place when the Microscope is inclined.— An *Annular Cell*, that may be used either as a 'live-box' or as a 'growing-slide,' has lately been devised by Mr. Weber (U. S.). It is a slip of plate-glass of the usual size and ordinary thickness, out of which a circular 'cell' of 3-4ths inch diameter is ground, in such a manner that its bottom is *convex* instead of concave, its shallowest part being in the centre, and the deepest round the margin. A small drop of the fluid to be examined being placed upon the central convexity (the highest

part of which should be almost flush with the general surface of the plate), and the thin glass-cover being placed upon it, the drop spreads itself out in a thin film, without finding its way into the deep furrow around it; and thus it holds-on the covering-glass by capillary attraction, while the furrow serves as an air-chamber. If the cover be cemented down by a ring of gold-size or dammar, so that the evaporation of the fluid is prevented, either Animal or Vegetable life may thus be maintained for some days, or, if the two should be balanced (as in an Aquarium), for some weeks.<sup>1</sup>—An improvement has been devised by Dr. Edmonds in the form of this Annular Cell; which he also makes to serve as a 'gas-chamber' for the introduction of gases or vapors into the Annular space. The central prominence is shaped as a truncated paraboloid; and while, by focussing in the object a 2-inch objective used as a condenser, a bright field is obtained, this may be exchanged for a dark field by putting the condenser out of focus (so that its light is thrown on the sides of the paraboloid), and by gumming a black disk on the centre of its under surface. A straight groove being cut in the slide, parallel to its long side, and tangentially to the annular groove which it should equal in depth, two fine glass tubes are cemented in it; one of them, which is left projecting beyond the end of the slide, being connected with a slender elastic tube through which gases or vapors may be projected into the annular space, while the other serves to convey them away.<sup>2</sup>

124. *Zoophyte Trough*.—For the examination of larger aquatic Animals or Plants under low or moderate powers, recourse may be advantageously had either to the original Zoophyte-trough of Mr. Lister (which is still kept on sale by most Makers), or to a form lately devised by Mr. Botterill, which has several advantages over the older one.

This consists of two plates of vulcanite, a back and a front, shaped as in Fig. 99, connected together by three brass screws; these, being fixed in the back plates, pass through the front, where their projecting ends are furnished with small milled-heads. Between these plates



Botterill's Zoophyte Trough.

are two rectangular plates of glass, cut to such a length as to lie between the two side-screws of the vulcanite plates, and having such a breadth that while their lower edges rest on the bottom-screw, their upper are flush with the top of the vulcanite disks. The glass plates are kept apart by a half-ring of vulcanized india-rubber, of such a diameter as to lie just outside of the semi-circular margin of the vulcanite plates; and they thus form the sides and bottom of a trough, which is made water-tight by a moderate pressure exerted by turning the milled-heads. The space between the two glass plates may be varied by using half-rings of different thicknesses; whilst, if it be desired to use a higher power than will work through ordinary glass, a front plate of *thin* glass may be substituted.—One great advantage of this arrangement is the facility with which the pieces composing

<sup>1</sup> "Journ. Roy. Microsc. Society," Vol. ii. (1879), p. 55.

<sup>2</sup> *Ibid.*, Vol. iii. (1880), p. 585.—This *Parabolized Gas-Slide* is made by Messrs. Beck.

it may be taken apart, either for cleaning or for the repair of a fracture—an accident to which the use of thin glass of course renders it specially liable.

125. *Compressor*.—The purpose of this instrument is to apply a gradual pressure to objects whose structure can only be made out when they are thinned by extension, while their organization is so delicate as to be confused or altogether destroyed by the slightest excess of pressure. For the examination of such, an instrument in which the degree of compression can be regulated with precision is almost indispensable. The Compressorium represented in Fig. 100 was originally devised by Schiek of Berlin; whilst its details were modified by M. de Quatrefages, who constantly employed it in his elaborate and most successful researches on the organization of the Marine Worms. Being, however, deficient in any provisions for securing the parallelism of the approximated surfaces, it has been superseded

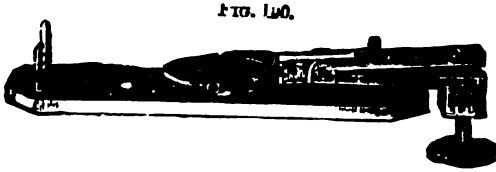

Schiek's Compressor.

by other forms devised expressly with that view.—In *Ross's Improved Compressor*, shown in Fig. 101, the upper plate D is attached to a slide that works between grooves in the vertical piece C, so that, when raised or lowered by the milled-head, it always maintains its parallelism to the lower plate A.

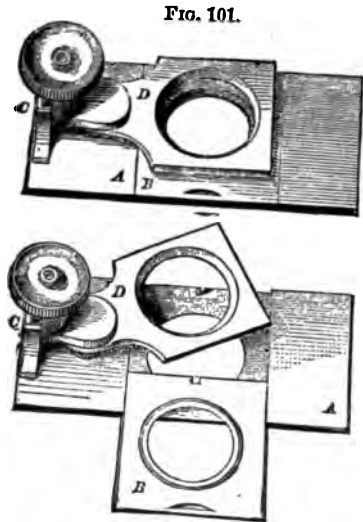

Ross's Improved Compressor.

The thin glass carried by the upper plate D (which can be turned aside on a swivel joint, as shown in the lower figure) is a square that slides into grooves on its under side, so as to be easily replaced if broken. The glass to which it is opposed is a circular disk lodged in a shallow socket in plate B, which is received into a part of the lower plate A that is sunk below the rest. The plate B carrying the lower glass can be drawn out (as shown in the lower figure) and laid upon the Dissecting Microscope, to be replaced in the Compressorium after the object has been prepared for compression. The only drawback to the use of this instrument lies in the inconvenience of using it in the reversed position so as to look at the object from its under side.—This reversion is provided for in the two forms of the instrument made by Messrs. Beck, which are shown in Figs. 102, 104. In both, the upper

and the lower glasses are fixed, upon a plan devised by Mr. Slack, by means of flat-headed screws, two to each glass (Fig. 103, A), the heads fitting into holes of the opposite frame, so as to permit the close approximation of the two glass surfaces. In their *Parallel Plate Compressor* (Fig. 102) the constant parallelism of the two plates is secured by the two parallel bars, *a, a*; while the degree of their approximation and pressure



is regulated by the screw *b*, which works out of centre in a conical hole of the lower frame, so that, the further it is introduced, the more closely the two frames, with their glasses, are approximated. This pattern works equally well whichever side is uppermost. In the *Reversible Cell Compressor* of the same makers (Figs. 103 B, 104) the upper glass is held down by a ring *a*, which screws-on to that which bears the lower one, giving any degree of pressure that may be required. When screwed together, they form a cell that fits into the plate *b*, and is attached to it by the milled-head *c*; by unscrewing which the cell can be instantly detached and replaced in a reverse position.—In all these Compressors, it is easy to vary the thickness of the glass within convenient limits; and the ob-

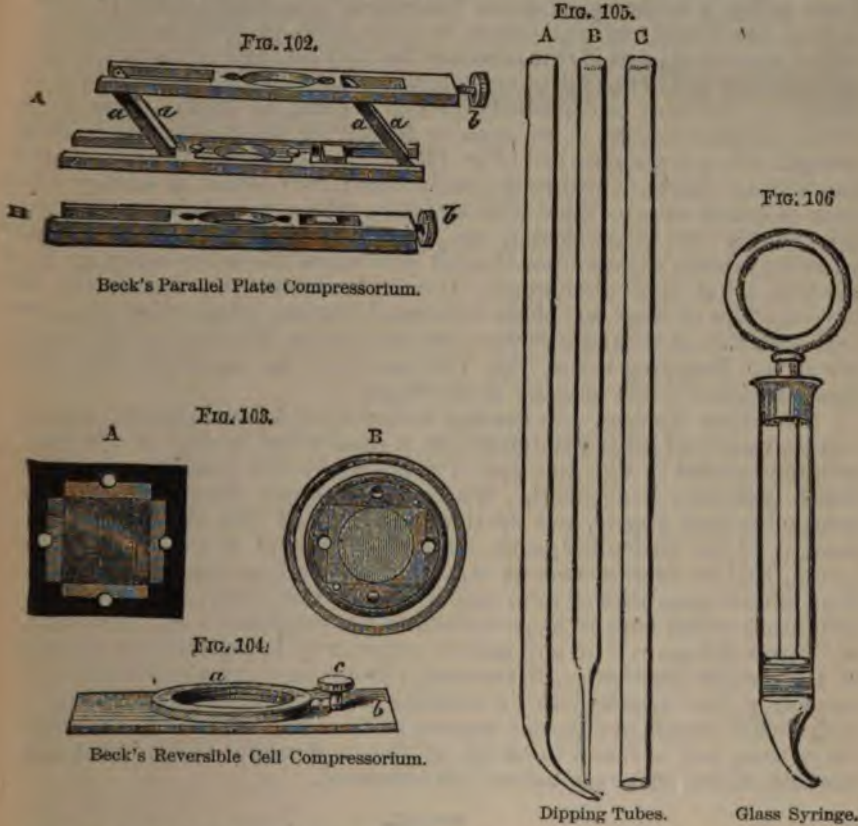

server should be always provided with a stock of glass slips and disks of the requisite sizes and of different thicknesses, suitable to the kind of investigation he may be prosecuting. As thin glasses, when used for compression, are very liable to fracture, the power of immediately replacing them without the employment of cement (as in Mr. Slack's construction) is a great convenience.

126. *Dipping Tubes.*—In every operation in which small quantities of liquid, or small objects contained in liquid, have to be dealt with by the Microscopist, he will find it a very great convenience to be provided with a set of Tubes of the forms represented in Fig. 105, but of some-



what larger dimensions. These were formerly designated as 'fishing tubes;' the purpose for which they were originally devised having been the fishing-out of Water-fleas, aquatic Insect-larvæ, the larger Animalcules, or other living objects distinguishable either by the unaided eye or by the assistance of a magnifying-glass, from the vessels that may contain them. But they are equally applicable, of course, to the selection of minute Plants; and they may be turned to many other no less useful purposes, some of which will be specified hereafter.—When it is desired to secure an object which can be seen either with the eye alone or with a magnifying-glass, one of these tubes is passed down into the liquid, its upper orifice having been previously closed by the forefinger, until its lower orifice is immediately above the object; the finger being then removed, the liquid suddenly rises into the tube, probably carrying the object up with it; and if this is seen to be the case, by putting the finger again on the top of the tube, its contents remain in it when the tube is lifted out, and may be deposited on a slip of glass, or on the lower disk of the Aquatic-box, or, if too copious for either receptacle, may be discharged into a large glass cell (Fig. 120). In thus fishing in jars for any but minute objects, it will be generally found convenient to employ the open-mouthed tube c; those with smaller orifices, b, c, being employed for 'fishing' for Animalcules, etc., in small bottles or tubes, or for selecting minute objects from the cell into which the water taken up by the tube a has been discharged. It will be found very convenient to have the tops of these last blown into small funnels, which shall be covered with thin sheet India-rubber; for their action (like that of the stopper of the Dropping-bottle, Fig. 138) can then be regulated with the greatest nicety by the pressure of the finger.

127. *Glass Syringe*.—In dealing with minute Aquatic objects, and in a great variety of other manipulations, a small Glass Syringe of the pattern represented in Fig. 106, and of about double the dimensions will be found extremely convenient. When this is firmly held between the fore and middle fingers, and the thumb is inserted into the ring at the summit of the piston-rod, such complete command is gained over the piston, that its motion may be regulated with the greatest nicety; and thus minute quantities of fluid may be removed or added, in the various operations which have to be performed in the preparation and mounting of Objects (Chap. v.); or any minute object may be selected (by the aid of the simple Microscope, if necessary) from amongst a number in the same drop, and transferred to a separate slip. A set of such Syringes, with points drawn to different degrees of fineness, and bent to different curvatures, will be found to be among the most useful 'tools' that the working Microscopist can have at his command.

FIG. 107.

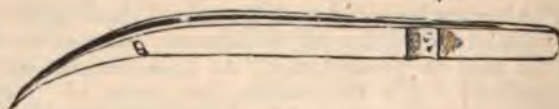

Forceps.

128. *Forceps*.—Another instrument so indispensable to the Microscopist as to be commonly considered an appendage to the Microscope, is the Forceps for taking up minute objects; many forms of this have been devised, of which one of the most convenient is represented in Fig. 107,

of something less than the actual size. As the forceps, in Marine researches, have continually to be plunged into sea-water, it is better that they should be made of brass or of German silver than of steel, since the latter rusts far more readily; and as they are not intended (like Dissecting-forceps) to take a firm grasp of the object, but merely to hold it, they may be made very light, and their spring-portion slender. As it is essential, however, to their utility, that their points should meet accurately, it is well that one of the blades should be furnished with a guide-pin passing through a hole in the other.

The foregoing constitute, it is believed, all the most important pieces of Apparatus which can be considered in the light of Accessories to the Microscope. Those which have been contrived to afford facilities for the preparation and mounting of Objects, will be described in a future chapter (Chap. v.). And the simple and efficient substitute which the Author has been accustomed to use for the *Frog-Plate* thought essential by many Microscopists, will be described in Chap. xx. under the head of Circulation of the Blood.

## CHAPTER IV.

## MANAGEMENT OF THE MICROSCOPE.

129. *Table.*—The Table on which the Microscope is placed when in use, should be one whose size enables it also to receive the various appurtenances which the observer finds it convenient to have within his reach, and whose steadiness is such as to allow of his arms being rested upon it without any yielding; it should, moreover, be so framed, as to be as free as possible from any tendency to transmit the vibrations of the building or floor whereon it stands. The working Microscopist will find it a matter of great convenience to have a Table specially set apart for his use, furnished with drawers, in which are contained the various Accessories he may require for the preparation and mounting of objects. If he should desire to carry about with him all the apparatus he may need for the prosecution of his investigations in different localities, and for the mounting of his preparations on the spot, he will find it very convenient to provide himself with a small Cabinet, fitted with drawers in which every requisite can be securely packed, and of such a height, that, when laid upon an ordinary table, it may bring up the Quekett or other Dissecting Microscope placed upon it to the position most convenient for use. —If the Microscope be one which is not very readily taken out from and put back into its case, it is very convenient to cover it with a large bell-glass; which may be so suspended from the ceiling, by a cord carrying a counterpoise at its other end, as to be raised or lowered with the least possible trouble, and to be entirely out of the way when the Microscope is in use. Similar but smaller bell-glasses (wine-glasses whose stems have been broken answer very well) are also useful for the protection of objects which are in course of being examined or prepared, and which it is desirable to seclude from dust.—For the purpose of Demonstration in the Lecture-room, a small traversing platform may be constructed to run easily upon rollers, and to carry the Microscope and Lamp securely clamped down upon it, so as to be passed from one observer to another. For Demonstration to a small party sitting round a circular table, it is convenient to employ a  $\Lambda$ -shaped platform, the vertical angle of which is pivoted to a weight placed in the centre of the table, whilst the angles

<sup>1</sup> The dimensions of the Cabinet which the Author has had constructed for himself (its size being so adapted to that of the box of his Crouch's Binocular that the two are received into the same travelling-case) are 14 inches long, 7 inches broad, and 4½ inches high. In the middle there are five shallow drawers, 5 inches broad, containing dissecting apparatus, large flat cells, glass-covers, syringes, etc.; on one side are two drawers, each 3½ inches broad, the upper one, containing slides, cells, etc., rather more than one inch deep inside, the lower, for larger pieces of apparatus, 2 inches deep; on the other side is a single drawer of the same breadth and 8½ inches deep, for bottles containing solutions, cements, etc.



at the base are supported upon castors, so that the platform may run round to each observer in succession. Or the table itself, if not too large, may rotate (like a dumb-waiter) upon its central pillar, as made by Messrs. Beck.

130. *Light*.—Whatever may be the purposes to which the Microscope is applied, it is a matter of the first importance to secure a pure and adequate Illumination. For the examination of the greater proportion of objects, *good daylight* is to be preferred to any other kind of light; but *good lamplight* is preferable to bad daylight, especially for the illumination of *opaque* objects. When daylight is employed, the Microscope should be placed near a window, whose aspect should be (as nearly as may be convenient) *opposite* to the side on which the sun is shining; for the light of the sun reflected from a bright cloud is that which the experienced Microscopist will almost always prefer, the rays proceeding from a cloudless blue sky being by no means so well-fitted for his purpose, and the dull lurid reflection of a dark cloud being the worst of all. The *direct* light of the sun is far too powerful to be ordinarily used with advantage, unless its intensity be moderated, either by reflection from a plaster of Paris mirror, or by passage through some 'Modifier' (§ 109); it is, however, occasionally used by some observers to work out intricate markings or fine color, and may sometimes be of advantage for these purposes, but without great care would be a fertile source of error.—The young Microscopist is earnestly recommended to make as much use of *daylight* as possible; not only because, in a large number of cases, the view of the object which it affords is more satisfactory than that which can be obtained by any kind of lamplight, but also because it is much less trying to the eyes. So great, indeed, is the difference between the two in this respect, that there are many who find themselves unable to carry on their observations for any length of time by lamplight, although they experience neither fatigue nor strain from many hours' continuous work by daylight. Even ordinary daylight may be considerably improved by the interposition of a glass globe of about six inches in diameter, filled with water; and this may also be advantageously used for the illumination of transparent objects by lamp-light, if the water be *very slightly* tinged with ammonio-sulphate of copper, which takes off the yellow glare.

131. *Lamps*.—When recourse is had to Artificial light, it is essential, not only that it should be of good quality, but that the arrangement for furnishing it should be suitable to the special wants of the Microscopist. The most useful light for ordinary use is that furnished by the steady and constant flame of a flat-wicked Lamp, fed with one of the best varieties of Paraffin oil. This (with its chimney-shade) should be so mounted on a stem rising from a secure base, as to be capable of adjustment to any height above the table; and on the same stem should also slide a telescope-arm having a bull's eye condenser attached to it by a ball-and-socket joint, in such a manner as to be adjustable in any position in regard to the flame, and at the same time to be carried upwards or downwards with the lamp—an arrangement originally devised by Mr.

FIG. 108.



Bockett Lamp.



Bockett (Fig. 108). It is preferable, however, to surround the glass chimney by a cylinder of porcelain, having a large aperture on one side for the passage of the light; and this may be advantageously blackened on the outside, contracted above into a cone, and furnished with a shade over the aperture (as in Mr. Swift's construction, Fig. 109), so that as little light as possible may enter the eye of the observer, except that which proceeds from the object. The lamp should be so hung as to be capable of being rotated on its own vertical axis; so that either the whole breadth of the flame, or its edge only, may be turned towards the mirror or condenser, according as diffused or concentrated light is required. In Mr. Swift's Lamp (Fig. 110), the Bull's-eye is mounted on a separate

FIG. 109.

Chimney and Shade of Swift's  
Microscope-Lamp.

FIG. 110.

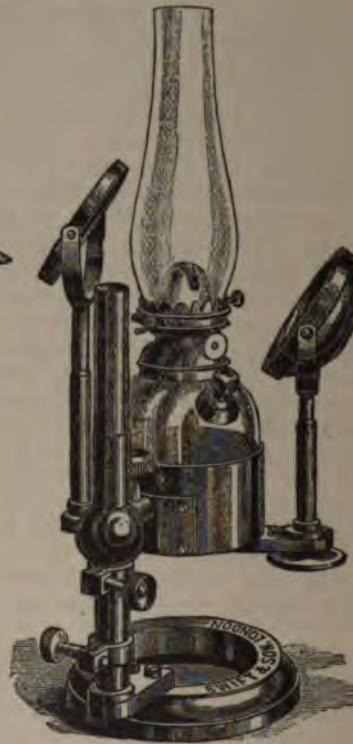

Swift's Microscope Lamp.

stem, capable both of vertical elevation and of horizontal adjustment, which rises from one end of an arm that is pivoted beneath the base of the brass cylinder that carries the lamp; and from the other end of this arm there rises a second stem, carrying a speculum, from which additional light may be reflected when desired. By rotating this arm on its pivot, the speculum and condenser are shifted together, so as to direct the full power of the flame wherever it may be required; an arrangement especially convenient for the illumination of opaque objects.—As it is often found extremely difficult to obtain an exact centering of the illumi-

nating beam, when very high powers are employed, by mere hand-shiftings of the lamp and its condenser, Messrs. Dallinger and Drysdale, in the admirable investigations of whose results a summary will be given hereafter (Chap. XI.), have found great advantage from the use of a Lamp mounted on a base to which a traversing horizontal movement can be given in any direction by rectangular screws, and furnished with an upright standard carrying two racks, on which the lamp itself and the bull's-eye condenser can be separately raised or lowered by milled-head pinions. By this more exact method of adjustment, the observer is able, after a little experience in its use, to *secure* that most perfect position of the flame and condenser, which ordinary hand-adjustment might not succeed in attaining until after a great expenditure of time and patience.<sup>1</sup>

132. *Position of the Light.*—When the Microscope is used by daylight, it will usually be found most convenient to place it in such a manner that the light shall be at the left hand of the observer. It is most important that no light should enter his eye, save that which comes to it through the Microscope; and the access of direct light can scarcely be avoided, when he sits with his face to the light. Of the two sides, it is more convenient to have the light on the *left*; first, because it is not interfered with by the right hand, when this is employed in giving the requisite direction to the mirror, or in adjusting the illuminating apparatus; and, secondly, because, as most persons in using a Monocular Microscope employ the right eye rather than the left, the projection of the nose serves to cut off those lateral rays, which, when the light comes from the right side, glance between the eye and the eye-piece. The *side-shades* fitted by Mr. Collins to the eye-pieces of his Harley Binocular (Fig. 49) may be advantageously employed with every instrument of that class.—When Artificial light is employed, the same general precautions should be taken. The Lamp should always be placed on the left side, unless some special reason exist for placing it otherwise; and if the Object under examination be *transparent*, the lamp should be placed at a distance from the eye about midway between that of the stage and that of the mirror. In the examination of objects of the greatest delicacy and difficulty, however, in which it is important to get rid of the reflection from the front surface of the Mirror, a rectangular Prism should be substituted for it, when the conditions of the observation necessitate the use of the Microscope in the vertical position; but when the instrument can be inclined, the Lamp may be most advantageously placed in the axis of the Achromatic Condenser or other Illuminator, so that its light may be transmitted to the object without intermediate reflection. If, on the other hand, the Object be *opaque*, the Lamp should be at a distance about midway behind the eye and the stage; so that its light may fall on the object at an angle of about 45° with the axis of the Microscope.—The passage of direct rays from the flame to the eye should be guarded against by the interposition of the lamp-shade; and no more light should be diffused through the apartment, than is absolutely necessary for other purposes. If observations of a very delicate nature are being made, it is desirable, alike by daylight and by lamplight, to exclude all lateral rays from the eye as completely as possible; and this may be readily accom-

<sup>1</sup> See "Monthly Microsc. Jour.," Vol. xv. (1876), p. 165.—As the directions given by these excellent observers for centering the illuminating beam are too long for citation, such as desire to profit by their experience must learn its results from their own account of them.



plished by means of a shade made like the upper part of a Mask, and lined with black cloth or velvet, which should be fixed on the ocular end of the Microscope.

133. *Care of the Eyes.*—Although most Microscopists who habitually work with the Monocular microscope acquire a habit of employing only *one* eye (generally the right), yet it will be decidedly advantageous to the beginner that he should learn to use either eye indifferently; since by employing and resting each alternately, he may work much longer without incurring unpleasant or injurious fatigue, than when he always employs the same.—Whether or not he do this, he will find it of great importance to acquire the habit of *keeping open the unemployed eye*. This, to such as are unaccustomed to it, seems at first very embarrassing, on account of the interference with the microscopic image, which is occasioned by the picture of surrounding objects formed upon the retina of the second eye; but the habit of restricting the attention to that impression only which is received through the microscopic eye, may generally be soon acquired; and when it has once been formed, all difficulty ceases. Those who find it unusually difficult to acquire this habit, may do well to learn it in the first instance with the assistance of the shade just described; the employment of which will permit the second eye to be kept open without any confusion.—So much advantage, however, is derived from the use of the Binocular arrangement, either stereoscopic or non-stereoscopic, that the Author would strongly recommend its use to every observer, save in cases of exceptional difficulty. There can be no doubt that the habitual use of the Microscope, for many hours together, especially by lamp-light, and with high magnifying powers, has a great tendency to injure the sight. Every Microscopist who thus occupies himself, therefore, will do well, as he values his eyes, not merely to adopt the various precautionary measures already specified, but rigorously to keep to the simple rule of *not continuing to observe any longer than he can do so without fatigue*.<sup>1</sup>

134. *Care of the Microscope.*—Before the Microscope is brought into use, the cleanliness and dryness of its glasses ought to be ascertained. If dust or moisture should have settled on the Mirror, this can be readily wiped off. If any spots should show themselves on the field of view, when it is illuminated by the mirror, these are probably due to particles adherent to one of the lenses of the Eye-piece: and this may be determined by turning the eye-piece round, which will cause the spots also to rotate, if their source lies in it. It may very probably be sufficient to wipe the upper surface of the eye-glass (by removing its cap), and the lower surface of the field-glass; but if, after this has been done, the spots should still present themselves, it will be necessary to unscrew the lenses from their sockets, and to wipe their inner surfaces; taking care to screw them firmly into their places again, and not to confuse the lenses of different eye-pieces. Sometimes the eye-glass is obscured by dust of

<sup>1</sup> The Author attributes to his rigorous observance of the above rule his entire freedom from any injurious affection of his visual organs, notwithstanding that, of the whole amount of Microscopic study which he has prosecuted for forty-five years past, a large proportion has been necessarily carried on by Artificial light, most of his daylight hours having been occupied in other ways. He has found the length of time during which he can 'microscopize' without the sense of fatigue, to vary greatly at different periods, half-an-hour's work being sometimes sufficient to induce discomfort, whilst on other occasions none has been left by three or four hours' almost continuous use of the instrument—his power of visual endurance being usually in relation to the vigor of his general system.



extreme fineness, which may be carried off by a smart puff of breath; the vapor which then remains upon the surface being readily dissipated by rapidly moving the glass backwards and forwards a few times through the air. And it is always desirable to try this plan in the first instance; since, however soft the substance with which the glasses are wiped, their polish is impaired in the end by the too frequent repetition of the process. The best material for wiping glass is a piece of soft wash-leather, from which the dust it generally contains has been well beaten out.—If the Object-glasses be carefully handled, and kept in their boxes when not in use, they will not be likely to require cleansing. One of the chief dangers, however, to which they are liable in the hands of an inexperienced Microscopist, arises from the neglect of precaution in using them with fluids; which, when allowed to come in contact with the surface of the outer glass, should be wiped off as soon as possible. In screwing and unscrewing them, great care should be taken to keep the glasses at a distance from the surface of the hands; since they are liable not only to be soiled by actual contact, but to be dimmed by the vaporous exhalation from skin which they do not touch. This dimness will be best dissipated by moving the glass quickly through the air. It will sometimes be found, on holding an Object-glass to the light, that particles either of ordinary dust, or more often of the black coating of the interior of the Microscope, have settled upon the surface of its back-lens; these are best removed by a clean and dry camel's-hair pencil. If any cloudiness or dust should still present itself in an object-glass, after its front and back surfaces have been carefully cleansed, it should be sent to the maker (if it be of English manufacture) to be taken to pieces, as the amateur will seldom succeed in doing this without injury to the work; the foreign combinations, however, being usually put together in a simpler manner, may be readily unscrewed, cleansed, and screwed together again. Not unfrequently an objective is rendered dim by the cracking of the cement by which the lenses are united, or by the insinuation of moisture between them; this last defect occasionally arises from a fault in the quality of the glass, which is technically said to 'sweat.' In neither of these cases has the Microscopist any resource, save in an Optician experienced in this kind of work; since his own attempts to remedy the defect are pretty sure to be attended with more injury than benefit.

135. *General Arrangement of the Microscope for Use.*—The inclined position of the instrument, already so frequently referred to, is that in which observation by it may be so much more advantageously carried-on than in any other, that recourse should always be had to it, unless particular circumstances render it unsuitable. The precise inclination that may prove to be most convenient will depend upon the 'build' of the Microscopist, upon the height of the observer's seat as compared with that of the table on which the instrument rests, and lastly, upon the sitting height of the individual; and it must be determined in each case by his own experience of what suits him best—that which he finds *most comfortable* being that in which he will be able not only to work the longest, but to see most distinctly.—The selection of the Objectives and Eye-pieces to be employed must be entirely determined by the character of the object. Large objects presenting no minute structural features should always be examined in the first instance by the *lowest* powers, whereby a general view of their nature is obtained; and since, with lenses of comparatively long focus and small angle of aperture, the precision of the focal adjustment is not of so much consequence as it is with the higher



powers, not only those parts can be seen, which are exactly in focus, but those also can be tolerably well distinguished which are not precisely in that plane, but are a little nearer or more remote. When the general aspect of an object has been sufficiently examined through low powers, its details may be scrutinized under a higher amplification; and this will be required in the first instance, if the object be so minute that little or nothing can be made out respecting it save when a very enlarged image is formed. The power needed in each particular case can only be learned by experience; that which is most suitable for the several classes of objects hereafter to be described, will be specified under each head. In the general examination of the larger class of objects, the range of power that is afforded by Zeiss's Adjustable Low-power Objective (§ 159, L) will often be found useful; whilst for the ready exchange of a low power for a higher one, great convenience is afforded by the Nose-piece (§ 96).

136. When the Microscopist wishes to augment his magnifying power, he has a choice between the employment of an Objective of shorter focus and the use of a deeper Eye-piece. If he possess a complete series of Objectives, he will frequently find it best to substitute one of these for another without changing the Eye-piece for a deeper one; but if his 'powers' be separated by wide intervals, he will be able to break the abruptness of the increase in amplification which they produce, by using each Objective first with the shallower and then with the deeper Eye-piece. Thus, if a Microscope be provided only with two Objectives of 1-inch and 1-4th inch focus respectively, and with two Eye-pieces, one nearly double the power of the other, such a range as the following may be obtained—60, 90, 240, 360 diameters; or, with two Objectives of somewhat shorter focus, and with deeper Eye-pieces (as in some French and German instruments)—88, 176, 350, 700 diameters. In the examination of large Opaque objects having uneven surfaces, it is generally preferable to increase the power by the Eye-piece rather than by the Objective; thus a more satisfactory view of such objects may usually be obtained with a 3-inch or 2-inch Objective and the B Eye-piece, than with a 1½-inch or 1-inch Objective and the A Eye-piece. The reason of this is, that in virtue of their smaller Angle of Aperture, the Objectives first named have a much greater amount of 'penetrating power' or 'focal depth' than the latter (§ 158, I.); and in the case just specified this quality is of the first importance. The use of the Draw-tube (§ 83) enables the Microscopist still further to vary the magnifying power of his instrument, and thus to obtain almost any exact number of diameters he may desire, within the limits to which he is restricted by the focal length of his Objectives. The advantage to be derived, however, either from 'deep Eye-piecing' or from the use of the Draw-tube, will mainly depend upon the quality of the Object-glass. For, if it be imperfectly corrected, its errors are so much exaggerated, that more is lost in definition than is gained in amplification; whilst, if its apertures be small, the loss of light is an equally serious drawback. On the other hand, an Objective of perfect correction and adequate angle of aperture will sustain this treatment with so little impairment in the perfection of its image, that a magnifying power may be obtained by its use, such as, with an inferior instrument, can only be derived from an Objective of much shorter focus combined with a shallow Eye-piece.—The author thinks it a great mistake, however, to attempt to make an Objective of *medium* power ordinarily do the work on which an Objective of *high* power should properly be employed. For not only can it not be brought up to this

without such an increase of its angle of aperture as unfits it for its own proper work, but the 'deep eye-piecing' required cannot be had recourse to habitually without exposing the eyes to severe overstrain. The advantage of *low* Eye-pieces and *deep* Objectives, as compared with *deep* Eye-pieces and *low* Objectives, has been very well put by likening it to the comfort of reading *large* print without spectacles, or with spectacles suited to the sight, and reading *small* print with a magnifying-glass.

137. In making the *Focal Adjustment*, when low powers are used, it will scarcely be necessary to employ any but the *coarse adjustment*, or 'quick motion;' provided that the rack be well cut, the pinion work in it smoothly and easily, without either 'spring,' 'loss of time,' or 'twist,' and the milled-head be large enough to give the requisite leverage. All these are requisites which should be found in every well-constructed instrument; and its possession of them should be tested, like its freedom from vibration, by the use of high powers, since a really good coarse adjustment should enable the observer to 'focus' an Objective of 1-8th inch with precision.—What is meant by 'spring' is the alteration which may often be observed to take place on the withdrawal of the hand; the object which has been brought precisely into focus, and which so remains as long as the milled-head is between the fingers, becoming indistinct when the milled-head is let go. The source of this fault may lie either in the rack-movement itself, or in the general framing of the instrument, which is so weak as to allow of displacement by the mere weight or pressure of the hand: should the latter be the case, the 'spring' may be in a great degree prevented by carefully abstaining from *bearing on* the milled-head, which should be simply *rotated* between the fingers.—By 'loss of time' is meant the want of sufficient readiness in the action of the pinion upon the rack, so that the milled-head may be moved slightly in either direction without affecting the body; thus occasioning a great diminution in the sensitiveness of the adjustment. This fault may sometimes be detected in Microscopes of the best original construction, which have gradually worked loose owing to the constancy with which they have been in employment; and it may often be corrected by tightening the screws that bring the pinion to bear against the rack.—And by 'twist' it is intended to express that apparent movement of the object across the field, which results from a real displacement of the axis of the body to one side or the other, owing to a want of correct fitting in the working parts.' As this last fault depends entirely on bad original workmanship, there is no remedy for it; but it is one which most seriously interferes with the convenient use of the instrument, however excellent may be its optical performance.—In the use of the coarse adjustment with an Objective of short focus, extreme care is necessary to avoid bringing it down upon the object, to the injury of one or both; for although the spring with which the tube for the reception of the object-glass is furnished, whenever the 'fine adjustment' is immediately applied to this, takes off the violence of the crushing action, yet such an action, even when thus moderated, can scarcely fail to damage or disturb the object, and *may* do great mischief to the lenses. Where the fine adjustment is otherwise provided for, still greater care is of course required,

<sup>1</sup> In testing either the 'coarse' or the 'fine' adjustment for 'twist,' care should be taken that the light reflected from the mirror is *axial* not *oblique*; since, if the illuminating rays are *inclined* to the optic axis, the object, when thrown out of focus, will appear to vanish *laterally*, which it does not do (provided the adjustments work well) when illuminated axially.

unless a spring 'safety-tube' be provided, into which the Objectives are screwed.—It is here, perhaps, well to notice, for the guidance of the young Microscopist, that the *actual* distance between the Objective and the object, when a distinct image is formed, is always considerably less than the *nominal* focal length of the objective.—One more precaution it may be well to specify; namely, that either in changing one object for another, or in substituting one Objective for another, save when powers of such focal length are employed as to remove all likelihood of injury, the Body should have its distance from the Stage increased by the 'coarse adjustment.' This precaution is absolutely necessary when Objectives of short focus are in use, to avoid injury either to the lenses or to the object; and when it is habitually practised with regard to these, it becomes so much like an 'acquired instinct,' as to be almost invariably practised in other cases.

138. In obtaining an exact Focal Adjustment with Objectives of less than half-an-inch focus, it will be generally found convenient to employ the *fine adjustment* or 'slow motion;' and as recourse will frequently be had to its assistance for other purposes also, it is very important that it should be well constructed and in good working order. The points to be particularly looked to in testing it, are for the most part the same with those already noticed in relation to the coarse movement. It should work smoothly and equably, producing that *graduated* alteration of the distance of the Objective from the object which it is its special duty to effect, without any jerking or irregularity. It should be so sensitive, that any movement of the milled-head should at once make its action apparent by an alteration in the distinctness of the image, when high powers are employed, without any 'loss of time.'<sup>1</sup> And its action should not give rise to any twisting or displacing movement of the image, which ought not to be in the least degree disturbed by any number of rotations of the milled-head, still less by a rotation through only a few degrees.—One great use of this adjustment consists in bringing into view different *strata* of the object, and this in such a gradual manner that their connection with one another shall be made apparent. Whether an Opaque or a Transparent object be under examination, only that part which is exactly in focus can be perfectly discerned under any power; and when high powers of large angular aperture are employed, this is the only part that can be seen at all. A minute alteration of the focus often causes so different a set of appearances to be presented, that, if this alteration be made abruptly, the relation of each to its predecessors can scarcely be even guessed at; and the gradual transition from the one to the other, which the 'slow motion' alone affords, is therefore necessary to the correct interpretation of either. To take a very simple case:—The transparent body of a certain animal being traversed by vessels lying in different planes, one set of these vessels is brought into view by one adjustment, another set by 'focussing' to a different plane; and the connection of the two sets of vessels, which may be the point of most importance in the whole anatomy of the animal, may be entirely overlooked for want of a 'fine adjustment,' whose graduated action shall enable one to be traced continuously into the other. What is true even

<sup>1</sup> It will sometimes happen that the 'slow motion' will seem not to act, merely because it has been so habitually worked in one direction rather than the other, that its screw has been turned too far. In that case, nothing more is required for its restoration to good working order, than turning the screw in the other direction, until it shall have reached about the middle of its range of action.



of low and medium powers, is of course true to a still greater degree as to high powers; for although the 'quick motion' may enable the observer to bring any stratum of the object into accurate focus, it is impossible for him by its means to secure that *transitional* 'focussing' which is often much more instructive than an exact adjustment at any one point. A clearer idea of the nature of a doubtful structure is, in fact, often derived from what is caught sight of *in the act* of changing the focus, than by the most attentive study and comparison of the different views obtained by any number of separate 'focussings.' The experienced Microscopist, therefore, whilst examining an object of almost any description, constantly keeps his finger on the milled-head of the 'slow motion,' and watches the effect produced by its revolution upon every feature which he distinguishes; never leaving off until he be satisfied that he has scrutinized not only the entire *surface*, but the entire *thickness* of the object. It will often happen that, where different structural features present themselves on different planes, it will be difficult or even impossible to determine with the Monocular microscope which of them is the nearer and which the more remote, unless it be ascertained by the use of the 'slow motion,' when they are successively brought into focus, whether the Objective has been moved *towards* or *away from* the object.<sup>1</sup> Even this, however, will not always succeed in certain of the most difficult cases, in which the difference of level is so slight as to be almost inappreciable; as, for instance, in the case of the markings on the siliceous valves of the Diatoms (Fig. 166).

139. When Objectives of short focus and of wide angular aperture are in use, something more is necessary (save in the case of 'homogeneous-immersion' lenses, § 20), than exact focal adjustment; this being the *adjustment of the Objective* itself, which is required to neutralize the disturbing effect of the glass cover upon the course of the rays proceeding from the object (§ 17),— unless (as in the Objectives now commonly made for Students' Microscopes) they are constructed for working *only* with cover-glasses of a certain standard thickness. For such adjustment, it will be recollected, a power of altering the distance between the front pair and the remainder of the combination is required; and this power is obtained in the following manner:—The front pair of lenses is fixed into a tube (Fig. 111, A), which slides over an anterior tube (B) by which the other two pairs are held; and it is drawn up or down by means of a collar (c), which works in a furrow cut in the inner tube, and upon a screw-thread cut in the outer, so that its revolution in the plane to which it is fixed by the one tube gives a vertical movement to the other. In one

FIG. 111.

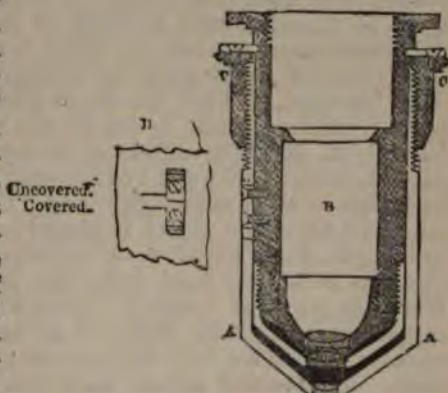

Section of Adjusting Object-Glass.

<sup>1</sup> It is in objects of this kind that the great advantage of the Stereoscopic Binocular arrangement makes itself most felt (§§ 30-40).



part of the outer tube an oblong slit is made, as seen at D, into which projects a small tongue screwed on the inner tube; at the side of the former two horizontal lines are engraved, one pointing to the word 'uncovered,' the other to the word 'covered;' whilst the latter is crossed by a horizontal mark, which is brought to coincide with either of the two lines by the rotation of the screw-collar, whereby the outer tube is moved up or down. When the mark has been made to point to the line 'uncovered,' it indicates that the distance of the lenses of the object-glass is such as to make it suitable for viewing an object without any interference from thin glass; when, on the other hand, the mark has been brought by the revolution of the screw-collar into coincidence with the line 'covered,' it indicates that the front lens has been brought into such proximity with the other two, as to produce a 'positive aberration' in the Objective, fitted to neutralize the 'negative aberration' produced by the interposition of a glass cover of extremest thickness. But unless this correction be made, with the greatest precision, to the thickness of the particular cover in use, the enlargement of the Angle of Aperture, to which Opticians have of late applied themselves with such remarkable success, becomes worse than useless; being a source of diminished instead of increased distinctness in the details of the object, which are far better seen with an Objective of greatly inferior aperture, possessing no special adjustment for the thickness of the glass. The following general rule is given by Mr. Wenham for securing the most efficient performance of an Object-glass with any ordinary object:—"Select any dark speck or opaque portion of the object, and bring the outline into perfect focus; then lay the finger on the milled-head of the fine motion, and move it briskly backwards and forwards in both directions from the first position. Observe the expansion of the dark outline of the object, both when within and when without the focus. If the greater expansion, or coma, is when the object is *without* the focus, or farthest from the Objective, the lenses must be placed farther asunder, or towards the mark 'uncovered.' If the greater coma is when the object is *within* the focus, or nearest to the Objective, the lenses must be brought closer together, or towards the mark 'covered.' When the object-glass is in proper adjustment, the expansion of the outline is exactly the same both within and without the focus." A different indication, however, is afforded by such 'test-objects' as present (like the Podura-scale and the Diatomaceæ) a set of distinct dots or other markings. For "if the dots have a tendency to run into lines when the object is placed *without* the focus, the glasses must be brought closer together; on the contrary, if the lines appear when the object is *within* the focal point, the lenses must be farther separated."<sup>1</sup> When the Angle of Aperture is very wide, the difference in the aspect of any severe test under different adjustments becomes at once evident; markings which are very distinct when the correction has been exactly made, disappearing almost instantaneously when the screw-collar is turned a little way round.<sup>2</sup>

<sup>1</sup> See "Quart. Journ. of Microsc. Science," Vol. ii. (1854), p. 188.

<sup>2</sup> Mr. Wenham remarks (loc. cit.), not without justice, upon the difficulty of making this adjustment even in the objectives of our best Opticians; and he states that he has himself succeeded much better by making the *outer* tube the fixture, and by making the tube that carries the other pairs slide within this; the motion being given by the action of an inclined slit in the revolving collar upon a pin that passes through a longitudinal slit in the outer tube, to be attached to the inner.—The admirable Objectives in the first-class American Opticians, are (the Author believes) always constructed so that the adjustment is effected by the movement of the *back* combinations, as long since recommended by Mr. Wenham.

140. Although the *most perfect* correction required for each particular object (which depends not merely upon the thickness of its glass cover, but upon that of the fluid or balsam in which it may be mounted) can only be found by experimental trial, yet for all ordinary purposes, the following simple method, first devised by Mr. Powell, will suffice. The object-glass, adjusted to 'uncovered,' is to be 'focussed' to the object; the screw-collar is next to be turned until the surface of the glass cover comes into focus, as may be perceived by the spots or striæ by which it may be marked; the object is then to be again brought into focus by the 'slow motion.' The edge of the screw-collar being graduated, the particular adjustment which any object may have been found to require, and of which a record has been kept, may be made again without any difficulty.—By Messrs. Smith and Beck, however, who first introduced this graduation, a further use is made of it. By experiments such as those described in the last paragraph, the correct adjustment is first found for any particular object, and the number of divisions observed through which the screw-collar must be moved in order to bring it back to 0°, the position suitable for an uncovered object. The thickness of the glass cover must then be measured by means of the 'slow motion'; this is done by bringing into exact focus, first the object itself, and then the surface of the glass cover, and by observing the number of divisions through which the milled-head (which is itself graduated) has passed in making this change. A definite ratio between that thickness of glass, and the correction required in that particular Objective, is thus established; and this serves as the guide to the requisite correction for any other thickness, which has been determined in like manner by the 'slow motion.' Thus, supposing a particular thickness of glass to be measured by 12 divisions of the milled-head of the 'slow motion,' and the most perfect performance of the Objective to be obtained by moving the screw-collar through 8 divisions, then a thickness of glass measured by 9 divisions of the milled-head would require the screw-collar to be adjusted to 6 divisions in order to obtain the best effect. The ratio between the two sets of divisions is by no means the same for different combinations; and it ought to be determined for each Objective by its maker, who will generally be the fittest judge of the best 'points' of his lenses; but when this ratio has been once ascertained, the adjustment for any thickness of glass with which the object may happen to be covered, is readily made by the Microscopist himself. Although this method appears somewhat more complex than that of Mr. Powell, yet it is more perfect; and when the ratio between the two sets of divisions has been once determined, the adjustment does not really involve more trouble.—Another use is made of this adjustment by Messrs. Smith and Beck; namely, to correct the disturbance in the performance of Objectives, which is made by the increase of distance between the Objective and the Eye-piece, occasioned by the use of the Draw-tube (§ 83). Accordingly they mark a scale of inches on the Draw-tube (which is useful for many other purposes), and direct that for every inch the body is lengthened, the screw-collar of the Objective shall be moved through a certain number of divisions.

141. *Arrangement for Transparent Objects.*—If the Object be already 'mounted' in a slide, nothing more is necessary, in order to bring it into the right position for viewing it, than to lay the slide upon the Object-platform of the Stage, and so to support it by means of the spring-clips, sliding-ledge, or other contrivance, that the part to be viewed is, as nearly as can be guessed, in the centre of the aperture of the stage, and

therefore in a line with the axis of the body. If the object be not 'mounted,' and be of such a kind that it is best seen dry, it may be simply laid upon the glass Stage-plate (§ 120), the ledge of which will prevent it from slipping off when the Microscope is inclined; and a plate of thin glass may be laid over it for its protection, if its delicacy should seem to render this desirable. If, again, it be disposed to curl up, so that a slight pressure is needed to flatten or extend it, recourse may be had to the use of the Aquatic Box (§ 122) or the Compressor (§ 125), without the introduction of any liquid between the surfaces of glass. In a very large proportion of cases, however, either the objects to be examined are already floating in fluid or it is preferable to examine them in fluid, on account of the greater distinctness with which they may be seen. If such objects be minute, and the quantity of liquid be small, the drop is simply to be laid on a slip of glass, and covered with a plate of thin glass; if the object or the quantity of liquid be larger, it will be better to place it in a concave slide or cell; whilst, if the object have dimensions which render even this inconvenient, the Zoophyte Trough (§ 124) will afford the best means for its examination.—In the case of minute living animals, whose movements it is desired limit (so as to keep them within the field of view) without restraining them by compression, the Author has found the following plan extremely convenient. The drop of water taken up with the animal by the Dipping-tube being allowed to fall into a concave slide (Fig. 122), the whole of the superfluous water may be removed by the Syringe (§ 127), only just as much being left as will keep the animal alive. If the animal be very minute, it is convenient to effect this withdrawal by placing the slide on the stage of the Dissecting Microscope (§ 44), and working the Syringe under the magnifier; and it will be found after a little practice, that the complete command which the operator has over the movements of the piston, as well as over the place of the point of the syringe, enables him to remove every drop of superfluous water without drawing the animal into the syringe. When, on the other hand, it is desired to isolate a particular animal from a number of others, the syringe may be conveniently used, after the same fashion, to draw it up and transfer it to another slide; care being, of course, taken that the syringe so employed has a sufficient aperture to receive it freely.—If it be wished to have recourse to *compression*, for the expansion or flattening of the object, this may be made upon the ordinary slide, by pressing down the thin-glass cover with a pointed stick; and this method which allow the pressure to be applied at the spot where it is most required, will generally be found preferable for delicate portions of tissue which are easily spread out, and which, in fact, require little other compression than is afforded by the weight of the glass cover, and by the capillary attraction which draws it into proximity with the slide beneath. A firmer and more enduring pressure may be exerted by the dexterous management of a well-constructed Aquatic Box; and this method is peculiarly valuable for confining the movements of minute animals, so as to keep them at rest under the field of the microscope, without killing them. It is where a firm but graduated pressure is required, for the flattening-out of the bodies of thin semi-transparent animals, without the necessity of removing them from the field of the Microscope, that the Compressor is most useful.

142. In whatever way the Object is submitted to examination, it must be first brought approximately into position, and supported there, just as if it were in a mounted Slide. The precise mode of effecting this will

differ, according to the particular plan of the instrument employed: thus, in some it is only the ledge itself that slides along the stage; in others it is a carriage of some kind, whereon the object-slide rests; in others, again, it is the entire platform itself that moves upon a fixed plane beneath. Having guided his object, as nearly as he can do by the unassisted eye, into its proper place, the Microscopist then brings his light (whether natural or artificial) to bear upon it, by turning the Mirror in such a direction as to reflect upon its under surface the rays which are received by itself from the sky or the lamp. The *concave* mirror is that which should always be first employed, the *plane* being reserved for special purposes; and it should bring the rays to convergence in or near the plane in which the object lies (Fig. 112). The distance at which it should be ordinarily set beneath the stage, is that at which it brings parallel rays to a focus; but this distance should be capable of elongation, by the lengthening of the stem to which the mirror is attached, since the rays diverging from a lamp at a short distance are not so soon brought to a focus. The correct focal adjustment of the Mirror may be judged by its formation of images of window-bars, chimneys, etc., upon any semi-transparent medium placed in the plane of the object. It is only, however, when small objects are being viewed under high magnifying powers, that such a concentration of the light reflected by the Mirror is either necessary or desirable; for, with large objects seen under low powers, the field would not in this mode be equally illuminated. The diffusion

of the light over a larger area may be secured, either by shifting the Mirror so much above or so much below its previous position, that the pencil will fall upon the object whilst still converging, or after it has met and diverged; or, on the other hand, by the interposition of a disk of Ground-glass in the course of the converging pencil,—this method which is peculiarly appropriate to lamp-light, being very easily had recourse to, if the diaphragm-plate have had its larger aperture fitted to receive such a disk (§ 98). The eye being now

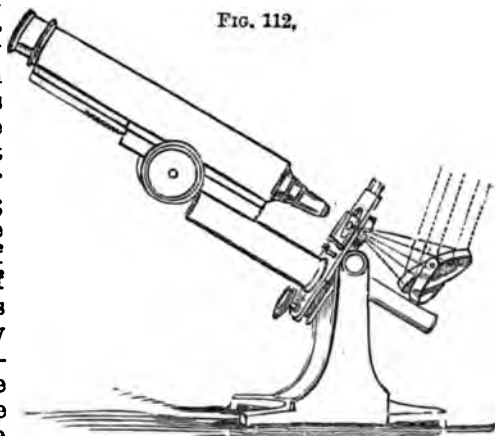

Arrangement of Microscope for Transparent Objects.

applied to the Eye-piece, and the body being 'focussed,' the object is to be brought into the exact position required by the use of the transverse movement, if the stage be provided with it; if not, by the use of the two hands, one moving the object-slide from side to side, the other pushing the ledge, fork, or holder that carries it, either forwards or backwards as may be required.—It is always to be remembered, in making such adjustments by the direct use of the hands, that, owing to the inverting action of the Microscope, the motion to be given to the object, whether lateral or vertical, must be precisely opposed to that which its image *seems* to require, save when Erectors (§§ 84, 86) are employed. When the object has been thus brought fully into view, the



Mirror may require a more accurate adjustment. What should be aimed-at is the diffusion of a clear and equable light over the entire field; and the observer should not be satisfied until he has attained this end. If the field should be darker on one side than on the other, the Mirror should be slightly turned in such a direction as to throw more light upon that side; perhaps in so doing, the light may be withdrawn from some part previously illuminated; and it may thus be found that the pencil is not large enough to light up the entire field. This may be owing to one of three causes: either the cone of rays may be received by the object too near to its focal apex, the remedy for which lies in an alteration in the distance of the Mirror from the stage; or, from the very oblique position of the mirror, the cone is too much narrowed across one of its diameters, and the remedy must be sought in a change in the position either of the Microscope or of the Lamp, so that the face of the Mirror may not be turned so much away from the axis of vision; or, again, from the centre of the Mirror being out of the optic axis of the instrument, so that the illuminating cone is projected obliquely,—an error which can be rectified without the least difficulty. If the cone of rays should come to a focus in the object, the field is not unlikely to be crossed (in the day-time) by window-bars or chimneys, or (at night) the form of the lamp-flame may be distinguished upon it; the former must be got rid of by a slight change in the inclination of the Mirror; and if the latter cannot be dissipated in the same way, the lamp should be brought a little nearer.

143. The equable illumination of the entire field having been thus obtained, the *quantity* of light to be admitted should be regulated by the Diaphragm-plate (§ 98). This must depend very much upon the nature of the object, and upon the intensity of the light. Generally speaking, the more transparent the object, the less light does it need for its most perfect display; and its most delicate markings are frequently only made visible, when the major part of the cone of rays has been cut off. Thus the movement of the *cilia*—those minute vibratile filaments with which almost every Animal is provided in some part of its organism, and which many of the humbler Plants also possess in the early stages of their existence—can only be discerned in many instances when the light is admitted through the smallest aperture. On the other hand, the less transparent objects usually require the stronger illumination which is afforded by a wider cone of rays; and there are some (such as semi-transparent sections of Fossil Teeth) which, even when viewed with low powers, are better seen with the intenser light afforded by the Achromatic Condenser.—In every case in which the object presents any considerable obstruction to the passage of the rays through it, great care should be taken to protect it entirely from *incident* light; since this extremely weakens the effect of that which is received into the Microscope by transmission. It is by daylight that this interference is most likely to occur; since, if the precautions already given (§ 132) respecting the use of lamp-light be observed, no great amount of light *can* fall upon the upper surface of the object. The observer will be warned that such an effect is being produced, by perceiving that there is a want not only of brightness but of clearness in the image, the field being veiled, as it were, by a kind of thin vapor; and he may at once satisfy himself of the cause, by interposing his hand between the stage and the source of light, when the immediate increase of brilliancy and distinctness will reveal to him the source of the previous deficiency in both. Nothing more is necessary for its permanent avoidance, than the interposition of an opaque screen

(blackened on the side towards the stage) between the window and the object; care being of course taken that the screen does not interfere with the passage of light to the mirror. Such a screen may be easily shaped and adapted either to be carried by the stage itself, or by the stand for the condenser; but it is seldom employed by Microscopists, as it interferes with access to the left side of the stage; and the interposition of the hand, so often as it may be needed, is more frequently had recourse to in preference, as the more convenient expedient. The young Microscopist who may be examining transparent objects by daylight, is recommended never to omit ascertaining whether the view which he may obtain of them is in any degree thus marred by incident light.

144. Although the illumination afforded by the Mirror alone is quite adequate for a very large proportion of the purposes for which the Microscope may be profitably employed (nothing else having been used by many of those who have made most valuable contributions to Science by means of this instrument), yet, when high magnifying powers are employed, and sometimes even when but a very moderate amplification is needed, great advantage is gained from the use of a Condenser. The form which has been described under the name of the *Webster Condenser* (§ 100) answers so well for most purposes, and may in addition be so easily converted into a 'black ground' Illuminator, that the working Microscopist will find it convenient to keep it always in place; substituting an *Achromatic Condenser* of greater power (§ 99) only when specially needed. Special care is needed in the use of this last, both as to the coincidence of its optic axis with that of the Microscope itself, and as to its focal distance from the object. The *centering* may be most readily accomplished by so adjusting the distance of the Condenser from the Stage (by the rack-and-pinion action or the sliding movement with which it is always provided), that a sharp circle of light shall be thrown on any semi-transparent medium laid upon it; then, on this being viewed through the Microscope with an Objective of sufficiently low power to take in the whole of it, if this circle be not found concentric with the field of view, the axis of the Condenser must be altered by means of the milled-head tangent-screws with which it is provided. Or a cap with a minute central aperture may be fitted on the top of the Condenser, and this aperture centered in the field of an objective of medium power. Or, again, a diaphragm with a very minute central perforation may be placed at a little distance *beneath* the Achromatic Condenser, and the image of this may be brought into the centre of the field of a 1-4th objective, which is the best arrangement when it is to be used with very high powers. The *focal adjustment* of the Condenser, on the other hand, must be made under the Objective which is to be employed in the examination of the object, by turning the Mirror in such a manner as to throw upon the visual image of the object (previously brought into the focus of the Microscope) an image of a chimney or a window-bar, if daylight be employed, or of the top, bottom, or edge of the lamp-flame, if lamp-light be in use; the focus of the condenser should then be so adjusted as to render the view of this as distinct as possible; and the direction of the Mirror should then be sufficiently changed to displace the image, and to substitute for it the clearest light that can be obtained. It will generally be found, however, that although such an exact focussing gives the most perfect results by Daylight, yet that by Lamp-light the best illumination is obtained when the Condenser is removed to a somewhat greater distance from the object, than that at which it gives a distinct image of the lamp. In every



case, indeed, in which it is desired to ascertain the effect of *variety* in the method of illumination, the effects of alterations in the distance of the condenser from the object should be tried; as it will often happen that delicate markings become visible when the condenser is a little *out* of focus, which cannot be distinguished when it is precisely *in* focus. The regulation of the *amount of light* transmitted through the object is often of the very first importance; and no means of accomplishing this is so convenient as a Graduating or Iris Diaphragm (§ 98). For some objects of great transparence, the White-Cloud illumination (§ 109) may be had recourse to with advantage.

145. There are many Transparent Objects, however, whose peculiar features can only be distinctly made out, when they are viewed by light transmitted through them *obliquely* instead of axially; and this is especially the case with such as have their surfaces marked by very delicate and closely-approximated furrows, the *direction* of the oblique rays being then a matter of primary importance. Thus, suppose that an object be marked by longitudinal striæ too delicate to be seen by ordinary direct light; the oblique light most fitted to bring them into view will be that proceeding in either of the directions c or d; that which falls upon it in the directions A and B tending to obscure the striæ rather than to disclose them. But if the striæ should be due to furrows or prominences which have one side inclined and the other side abrupt, they will not be brought into view indifferently by light from c or from d,

but will be shown best by that which makes the strongest shadow: hence, if there be a projecting ridge, with an abrupt side looking towards c, it will be best seen by light from d; whilst if there be a furrow with a steep bank on the side of c, it will be by light from that side that it will be best displayed. But it is not at all unfrequent for the longitudinal striæ to be crossed by others; and these transverse striæ will usually be best seen by the light that is least favorable for the longitudinal; so that, in order to bring them into distinct view, either the illuminating pencil or the object must be moved a quarter round. The simplest mode of obtaining this end, is to make the Mirror capable of being turned into such a position as to reflect light into the object from one side and at a very oblique angle (which is best done by the Zentmayer arrangement); and to give the Stage a rotatory movement, so that the object may be presented to that light under every azimuth.

146. For objects of greater difficulty, however, it is better to have recourse to the Accessories already described (§§ 101-108), which are specially provided to furnish oblique illumination in the most effectual manner. A good example of the variety of appearances which the same object may exhibit, when illuminated from different azimuths, and with slight changes of focussing, is shown in Fig. 113, which represents portions of a valve of *Pleurosigma formosum* as seen under a power of 1300 diameters; the markings shown at A, B, and c, being brought-out by *oblique* light in different directions, which, however, when carefully used, does not produce these erroneous aspects; whilst at d, is shown the effect of *axial* illumination with the Achromatic Condenser.—It cannot be too strongly impressed on the young Microscopist, however, that the special value of *very oblique* illumination is limited to the resolution of 'test-objects;' and that for the ordinary purposes of *scientific* study and research, *axial* illumination is generally preferable. As in regard to the qualities of Objectives (§ 55), so in respect to Illumination, may



it be confidently asserted that the solution of the most difficult Biological problems to which the Microscope has been yet applied, has been attained by arrangements by no means the most favorable to the discernment of the markings on Diatom-valves or the lines on Nobert's test-plate; and that, conversely, the arrangements specially effective for the 'resolution' of the most difficult *lined* 'tests' have not, as yet, been shown to have much value in Biological investigation (§ 156).

147. There are many kinds of Transparent objects—especially such as either consist of thin plates, disks, or spicules of Siliceous or Calcareous matter, or contain such bodies—which are peculiarly well seen under the *Black-ground* illumination (§§ 104, 105); for not only does the brilliant luminosity which they then present, in contrast with the dark ground behind them, show their forms to extraordinary advantage; but this mode of illumination imparts to them an appearance of solidity which they do not exhibit by ordinary transmitted light (§ 103); and it also frequently brings out surface-markings which are not otherwise distinguishable. Hence when any object is under examination that can be supposed to be a good subject for this method, the trial of it should never be omitted. For low powers, the use of the Spot-lens or the Webster Condenser with the central stop will be found sufficiently satisfactory; for the higher, the Paraboloid or the Reflex Illuminator should be employed.—Similar general remarks may be made respecting the examination of objects by *Polarized* light (§ 110). Some of the most striking effects of this kind of illumination are

produced upon bodies whose particles have a crystalline aggregation; and hence it may often be employed with great advantage to bring such bodies into view, when they would not otherwise be distinguished: thus, for example, the *raphides* of Plants are much more clearly made out by its means, in the midst of the tissues, than they can be by any other. But the peculiar effects of Polarized light are also exerted upon a great number of other Organized substances, both animal and vegetable; and it often reveals differences in the arrangement or in the relative density of their component particles, the existence of which would not otherwise have been suspected; hence the Microscopist will do well to have recourse to it, whenever he may have the least suspicion that its use can give him an additional power of discrimination.

148. *Arrangement for Opaque Objects.*—There are many objects of the most interesting character, the opacity of which entirely forbids the transmission of light through them, and of which, therefore, the *surfaces* only can be viewed by means of the *incident* rays which they *reflect*. These are, for the most part, objects of comparatively large dimensions,

FIG. 113.

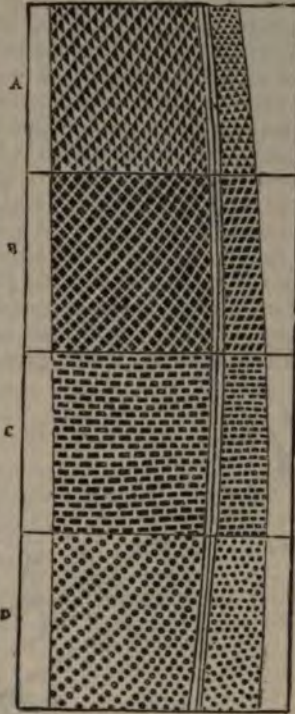

Valve of *Pleurosigma formosum*, with portions A, B, C, D, showing diverse effects of illumination.



for which a low magnifying power suffices; and it is specially important, in the examination of such objects, not to use a lens of shorter focus than is absolutely necessary for discerning the details of the structure; since, the longer the focus of the Objective employed, the less is the indistinctness produced by inequalities of the surface, and the larger, too, may be its aperture, so as to admit a greater quantity of light, to the great improvement of the brightness of the image. Objectives of long focus are especially required in Microscopes that are to be used for Educational purposes;<sup>1</sup> and an endless variety of 'common objects' suitable to these may be found by such as will take the trouble to search for them.—The mode of bringing Opaque objects under view will differ according to their 'mounting,' and to the manner in which it is desired to illuminate them. If the object be mounted in a 'slide' of glass or wood, upon a large Opaque surface, the slide must be laid on the stage in the usual manner, and the object brought as nearly as possible into position by the eye alone (§ 141). If it be not so mounted it may be simply laid upon the glass Stage-plate, resting against its ledge; and the Diaphragm-plate must then be so turned as to afford it a black background, light being thrown upon it by a Condensing Lens or Bull's-eye placed as in Fig. 114, or (still better) by Beck's Parabolic Speculum, which gives a far better illumination by diffused daylight

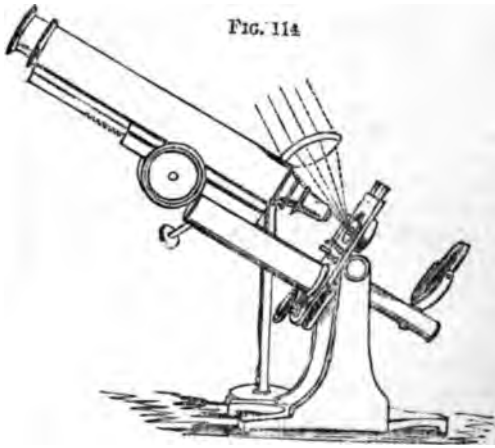

Arrangement of Microscope for Opaque Objects.

than can be obtained by any other means yet devised, and which is equally well adapted to lamp-light, when used in combination with the Bull's-eye (§ 114). Direct sunlight cannot be employed without the production of an injurious glare, and the risk of burning the object; but the sunlight reflected from a bright cloud is the best light possible. When a Condensing Lens is used, it should always be placed at right angles to the direction of the illuminating rays, and at a distance from the object which will be determined by the size of the surface to be illuminated and by the kind of light required. If the magnifying power employed be high, and the field of view be consequently limited, it will be desirable so to adjust the lens as to bring the cone of rays to a point upon the part of the object under examination; and this adjustment can only be rightly made whilst the object is kept in view under the Microscope, the condenser being moved in various modes until that position has been found for it in which it gives the best light. If, on the other hand, the power be low, and it be desired to spread the light equably over a large field, the Condenser should be placed either within or beyond its focal distance; and

<sup>1</sup> The makers of Educational Microscopes supply at a small cost, single (triplet) combinations of 3 inches, 2 inches, or 1½ inch focus, or dividing combinations of half inch and 1 inch, 1 inch and 2 inches, or 1½ inch and 3 inches, which are quite adequate for ordinary requirements.

here, too, the best position will be ascertained by trial. It will often be desirable also to vary both the obliquity of the light and the direction in which it falls upon the object; the aspect of which is greatly affected by the manner in which the shadows are projected upon its surface, and in which the lights are reflected from the various points of it. Many objects, indeed, which are distinguished by their striking appearance when the light falls upon them on one side, are entirely destitute both of brilliancy of color and of sharpness of outline when illuminated from the opposite side. Hence it is always desirable to try the effect of changing the position of the object; which, if it be 'mounted,' may be first shifted by merely reversing the place of the two ends of the slide, and then, if this be not satisfactory, may be more completely as well as more gradually altered by making the object-platform itself to rotate. With regard to the obliquity of the illuminating rays, it is well to remark, that if the object be 'mounted' under a glass cover, and the incident rays fall at too great an angle with the perpendicular, a large proportion of them will be reflected, and the brilliancy of the object will be greatly impaired; and hence when Opaque objects are being examined under high powers with a very oblique illuminating pencil, they should always be *uncovered*.

149. The same general arrangement must be made when Artificial light is used for the illumination of Opaque objects; the Lamp being placed in such a position in regard to the Stage that its rays may fall in the direction indicated in Fig. 114, and these rays being collected and concentrated by the Condenser, as already directed. Since the rays proceeding from a lamp within a short distance are already diverging, they will not be brought by the Condenser to such speedy convergence as are the parallel rays of daylight; and it must, therefore, be farther removed from the object to produce the same effect. By modifying the distance of the Condenser from the lamp and from the object respectively, the cone of rays may be brought nearly to a focus, or it may be spread almost equably over a large surface, as may be desired. And the same effect may be produced by shifting the position of the Condenser, when the Parabolic Speculum is employed in combination with it. No more effective illumination can be desired for objects viewed under the low powers to which the Parabolic Speculum is adapted, than that which is afforded by this combination; the Bockett Lamp (Fig. 108) supplying a most convenient means of using it, as the Author can testify from a very large experience. In the illumination of Opaque objects, Artificial light has the advantage over ordinary daylight, of being more easily concentrated to the precise degree, and of being more readily made to fall in the precise direction, that may be found most advantageous. Moreover, the contrast of light and shadow will be more strongly marked when no light falls upon the object except that proceeding from the Lamp used for its illumination, than it can be when the shadows are partially lightened by the rays which fall upon the object from every quarter, as must be the case if it be viewed by daylight.—If a more concentrated light be required, the flame of the lamp may be turned edgewise to the object, and the small Condensing-lens may be used in combination with the Bull's eye; being so placed as to receive the cone projected by it, and to bring its rays to a more exact convergence. It was in this way that Mr. Beck obtained the views of the *Podura*-scale given in plate II., Figs. 4, 5. In this manner very minute bodies may be viewed as Opaque objects under high magnifying powers, provided that the brasswork of the extremities of the Objectives be so bevelled-off as to allow the illuminating

cone to have access to the object. As none but a very oblique illumination, however, can be thus obtained, the view of the object will be by no means complete, unless it be supplemented by that which may be obtained by means of the Vertical Illuminator (§ 116), which supplies for high powers the kind of illumination that is given by the Lieberkühn for the lower.

150. There are many Opaque objects, such as *Foraminifera*, wh h it is desirable to view from all sides, in order that their features may be completely made out. This may be readily done with objects mounted in slides, when the Microscope is provided with the Zentmayer stage, by inclining the stage to one side or the other (first taking care that the object is well secured upon it), and then giving rotation to the object-plate. For such objects as can be conveniently attached to small disks, Beck's Disk-holder (Fig. 94), affords by far the most convenient and effective mode of presenting them in every variety of aspect; but the disks may also be held by attached pins, either in the Stage-forceps, or by the insertion of the pins into the cork-box at its other end (§ 118), a variety of movements being given in either case by turning the forceps in its tube. So, again, many small objects, such as parts of Insects, may be grasped in the Stage-forceps itself, and by a little care in manipulation, each aspect may be brought into view successively. In either of these cases, the Lieberkühn may be employed for their illumination; and light of considerable obliquity may be obtained by its means, either by turning the Mirror out of the axis, or by covering part of the reflecting surface of the Lieberkühn by a cap, or by a combination of both methods. Whenever the Lieberkühn is employed, care must be taken that the direct light from the Mirror is entirely stopped-out by the interposition of a 'dark well' or of a black disk, of such a size as to fill the field given by the particular Objective employed, but not to pass much beyond it. Opaque objects that are permanently mounted either upon cardboard disks, or in the slides specially provided for them, may be presented to the Microscope in a considerable variety of directions by means of Morris's Object-holder (Fig. 95); which, however, can only be employed with side-illumination. If it be desired to make the most advantageous use of this appliance, objects mounted in slides should be so placed that the parts to be brought into view by its tilting movement may look towards the long edges of the slide; since it is obvious that a much greater inclination may be given to it in either of these directions, than in the direction of either of its extremities.

151. *Errors of Interpretation.*—The correctness of the conclusions which the Microscopist will draw regarding the nature of any object, from the visual appearances which it presents to him when examined in the various modes now specified, will necessarily depend in a great degree upon his previous experience in Microscopic observation, and upon his knowledge of the class of bodies to which the particular specimen may belong. Not only are observations of *any* kind liable to certain fallacies, arising out of the previous notions which the observer may entertain in regard to the constitution of the objects or the nature of the actions to which his attention is directed, but even the most practised observer is apt to take no note of such phenomena as his mind is not prepared to appreciate. Errors and imperfections of this kind can only be corrected, it is obvious, by general advance in scientific knowledge; but the history of them affords a useful warning against hasty conclusions drawn from a too cursory examination. If the history of almost *any* scientific investi-

gation were fully made known, it would generally appear that the stability and completeness of the conclusions finally arrived-at had only been attained after many modifications, or even entire alterations, of doctrine. And it is, therefore, of such great importance as to be almost essential to the correctness of our conclusions, that they should not be finally formed and announced until they have been tested in every conceivable mode. It is due to Science that it should be burdened with as few false facts and false doctrines as possible. It is due to other truth-seekers that they should not be misled, to the great waste of *their* time and pains, by *our* errors. And it is due to ourselves that we should not commit our reputation to the chance of impairment, by the premature formation and publication of conclusions, which may be at once reversed by other observers better informed than ourselves, or may be proved to be fallacious at some future time, perhaps even by our own more extended and careful researches. The *suspension of the judgment, whenever there seems room for doubt*, is a lesson inculcated by all those Philosophers who have gained the highest repute for practical wisdom; and it is one which the Microscopist cannot too soon learn, or too constantly practise.—Besides these general warnings, however, certain special cautions should be given to the young Microscopist, with regard to errors into which he is liable to be led, even when the very best instruments are employed.

152. Errors of interpretation arising from the imperfection of the *focal adjustment* are not at all uncommon amongst young Microscopists. With lenses of high power, and especially with those of large angular aperture, it very seldom happens that all the parts of an object, however minute and flat it may be, can be in focus together; and hence, when the focal adjustment is exactly made for one part, everything that is not in exact focus is not only more or less indistinct, but is often wrongly represented. The indistinctness of outline will sometimes present the appearance of a pellucid border, which, like the diffraction-band, may be mistaken for actual substance. But the most common error is that which is produced by the reversal of the lights and shadows resulting from the refractive powers of the object itself; thus, the bi-concavity of the blood-disks of Human (and other Mammalian) Blood occasions their centres to appear *dark* when in the focus of the Microscope, through the divergence of the rays which it occasions; but when they are brought a little within the focus by a slight approximation of the object-glass, the centres appear brighter than the peripheral parts of the disks. An opposite reversal presents itself in the markings of certain *Diatoms*, which, like *Pleurosigma angulatum*, present, when exactly focussed, the aspect of rows of hemispherical beads (Fig. 166, A).

When the surface is viewed a little inside the focus, its aspect is that shown at A, Fig. 115; whilst, when the surface is slightly beyond the focus (B), the hexagonal areolæ are dark, and the intervening partitions light.—The *experienced* Microscopist will find in the optical effects produced by variations of focal adjustment the most certain indications in regard to the nature of such inequalities of surface as are too minute to be made apparent by the use of the Stereoscopic Binocular. For superficial *elevations* must necessarily appear



False hexagonal areolation of *Pleurosigma angulatum*, as seen in a Photograph magnified to 15,000 diameters.



brightest when the distance between the Objective and the object is *increased*, whilst *depressions* must appear brightest when that distance is diminished.—The Student should be warned against supposing that in all cases, the most *positive* and *striking* appearance is the truest; for this is often not the case. Mr. Slack's *optical illusion*, or *silica-crack slide*,<sup>1</sup> illustrates an error of this description. A drop of water holding colloid silica in solution is allowed to evaporate on a glass slide, and, when quite dry, is covered with thin glass to keep it clean. The silica deposited in this way is curiously cracked; and the *finest* of these cracks can be made to present a very positive and de-ceptive appearance of being raised bodies like glass threads. It is also easy to obtain diffraction-lines at their edges, giving an appearance of duplicity to that which is really single.

153. A very important and very frequent source of error, which sometimes operates even on experienced Microscopists, lies in the refractive influence exerted by certain peculiarities in the internal structure of objects upon the rays of light transmitted through them; this influence being of a nature to give rise to appearances in the image, which suggest to the observer an idea of their cause that may be altogether different from the reality. Of this fallacy we have a 'pregnant instance' in the misinterpretation of the nature of the *lacunæ* and *canaliculi* of Bone, which were long supposed to be solid corpuscles with radiating filaments of peculiar opacity, instead of being, as is now universally admitted, minute chambers with diverging passages excavated in the solid osseous substance. For, just as the convexity of its surface will cause a transparent cylinder to show a bright axial band,<sup>2</sup> so will the concavity of the internal surfaces of the cavities or tubes hollowed-out in the midst of highly-refracting substances, occasion a divergence of the rays passing through them, and consequently render them so dark that they are easily mistaken for opaque solids. That such is the case with the so-called 'bone corpuscles,' is shown by the effect of the infiltration of Canada balsam through the osseous substance; for when this fills up the excavations, being nearly of the same refractive power with the bone itself, it obliterates them altogether.—So, again, if a person who is unaccustomed to the use of the Microscope should have his attention directed to a preparation mounted in liquid or in balsam that might chance to contain *air-bubbles*, he will be almost certain to be so much more strongly impressed by the appearances of these than by that of the object, that his first remark will be upon the number of strange-looking black rings which he sees, and his first inquiry will be in regard to their meaning.

154. Although no experienced Microscopist could now be led astray by such obvious fallacies as those alluded to, it is necessary to notice them as warnings to those who have still to go through the same education. The best method of learning to appreciate the class of appearances in question, is the comparison of the aspect of globules of Oil in water, with that of globules of Water in oil, or of bubbles of Air in water or Canada balsam. This comparison may be very readily made by shaking up some oil with water to which a little gum has been added, so as to form an emulsion; or by simply placing a drop of oil of turpentine (colored by magenta or carmine) and a drop of water together on a slip of glass, lay-

<sup>1</sup> "Monthly Microscopical Journal," Vol. v. (1872), p. 14.

<sup>2</sup> This was the appearance which gave rise to the erroneous notion that long prevailed amongst Microscopic observers, and still lingers in the Public mind, of the *tubular* structure of the *Human Hair*.

ing a thin-glass cover upon them, and then moving the cover several times backwards and forwards upon the slide. Now when such a mixture is examined with a sufficiently high magnifying power, all the globules present nearly the same appearance, namely, dark margins with bright centres; but when the test of alteration of the focus is applied to them, the difference is at once revealed; for whilst the globules of Oil surrounded by water become *darker* as the object-glass is *depressed*, and *lighter* as it is *raised*, those of Water surrounded by oil become *more luminous* as the object-glass is *depressed*, and *darker* as it is *raised*. The reason of this lies in the fact that the high refracting power of the Oil causes each of its globules to act like a double-convex lens of very short focus; and as this will bring the rays which pass through it into convergence *above* the globule (*i. e.*, between the globule and the Objective), its brightest image is given when the object-glass is removed somewhat farther from it than the exact focal distance of the object. On the other hand, the globule of Water in oil, or the minute bubble of air in water or balsam, acts, in virtue of its inferior refractive power, like a double-concave lens; and as the rays of this diverge from a virtual focus *below* the globule (*i. e.*, between the globule and the mirror), the spot of greatest luminosity will be found by causing the object-glass to approach *within* the proper focus. A thorough mastery of these appearances is very important in the study of the 'protoplasm' of Plants—the 'sarcode' of Animals,—which includes oil-particles, together with spaces occupied by a watery fluid, which (having been at one time supposed to be *void*) are known as 'vacuoles.'

155. Among the sources of fallacy by which the young Microscopist is liable to be misled, one of the most curious is the *movement* exhibited by very minute particles of nearly all bodies that are sufficiently finely divided, when suspended in water or other fluids. This movement was first observed in the fine granular particles which exist in great abundance in the contents of the Pollengrains of plants (sometimes termed the *fovilla*), and which are set free by crushing them; and it was imagined that they indicated the possession of some special vital endowment by these particles, analogous to that of the Spermatozoa of animals. In the year 1827, however, it was announced by Dr. Robert Brown that numerous other substances, Organic and Inorganic, when reduced to a state of equally minute division, exhibit a like movement, so that it cannot be regarded as indicative of any endowment peculiar to the *fovilla* granules; and subsequent researches have shown that there is no known exception to the rule that such motion takes place in the particles of all substances, though some require to be more finely divided than others before they will exhibit it. The closer the conformity between the specific gravity of the solid particles and that of the liquid, the less minute need be that reduction in their size which is a necessary condition of their movement: and thus Carmine, Indigo, or Gamboge rubbed up with water, show it extremely well; whilst the particles of Metals, which are from seven to twenty times as heavy as water, require to be reduced to a minuteness many times greater, before they will exhibit it. The movement is chiefly of an oscillatory kind; but the particles also rotate backwards and forwards upon their axes, and gradually change their places in the field of view. The movement of the smallest particles is the most energetic, and the largest (exceeding 1-5000th of an inch) are quite motionless, whilst those of intermediate size move with comparative inertness. A drop of common ink which has been exposed to the air for some weeks, or a drop

of fine clay (such as the prepared *kaolin* used by Photographers) shaken-up with water, is recommended by Prof. Jevons,<sup>1</sup> who has recently studied this subject, as showing the movement (which he designates *pedesis*) extremely well. But none of the particles he has examined are so active as those of pumice-stone that has been ground-up in an agate mortar; for these are seen under the microscope to leap and swarm with an incessant quivering movement, so rapid that it is impossible to follow the course of a particle which probably changes its direction of motion 15 or 20 times in a second. The distance through which a particle moves at any one bound is usually less than 1-5000th of an inch. This 'Brownian movement' (as it is commonly termed) is not due to evaporation of the liquid: for it continues, without the least abatement of energy, in a drop of aqueous fluid that is completely surrounded by oil, and is therefore cut off from all possibility of evaporation; and it has been known to continue for many years in a small quantity of fluid inclosed between two glasses in an air-tight case. And, for the same reason, it can scarcely be connected with chemical change. But the observations of Prof. Jevons (loc. cit.) show that it is greatly affected by the admixture of various substances with water; being, for example, increased by a small admixture of gum, while it is checked by an extremely minute admixture of sulphuric acid or of various saline compounds, these (as Prof. J. points out) being all such as increase the conducting power of water for Electricity. The rate of subsidence of finely-divided clays or other particles suspended in water, thus greatly depends upon the activity of their 'Brownian movement;' for, when this is brought to a stand, the particles aggregate and sink, so that the liquid clears itself.—In any case in which the motions of very minute particles, of whatever kind, are in question, it is necessary to make allowance for this 'molecular' movement; and the young Microscopist will therefore do well to familiarize himself with its ordinary characters, by the careful observation of it in such cases as those just named, and in any others in which he may meet with it.<sup>2</sup>

156. *Diffraction*.—The course of Light-rays is altered not only by *refraction* when they pass from one transparent medium into another, and by *reflection* when they fall on polished surfaces which they do not enter, but also by *inflection* at the edges of objects by which they pass; and as the differently colored rays which altogether make up white light are affected by such inflection in different degrees, they are separated by it (as by refractive 'dispersion') into colored bands; the phenomenon being altogether known as *diffraction*. This may be made evident by causing a beam of sunlight to enter a darkened room through a very narrow slit, and to fall on a white screen; for the narrow line of white light will show a border of colored fringes, which become wider as the slit is narrowed; and if these fringes be viewed through a piece of colored glass, which allows only rays of its own color to pass, they will appear as a succession of bands alternately bright and dark. This alternation is produced by the *interference* of the Light-waves; just as the alternations of sound and comparative silence termed 'beats,' which are heard when two slightly different tones are being sounded together, are due to the inter-

<sup>1</sup> "Quarterly Journal of Science," N. S., Vol. viii. (1878), p. 173.

<sup>2</sup> See also the Rev. J. Delsaulx "On the Thermo-Dynamic Origin of the Brownian Motions" in "Monthly Journ. of Microsc. Sci.," Vol. xviii. (1877), p. 1; and Dr. W. M. Ord "On some Causes of Brownian Movements" in "Journ. of Roy. Microsc. Soc.," Vol. ii. (1879), p. 656.

ference of the Sound-waves.<sup>1</sup> The colored fringes are produced by the superposition of all these bands.—When, again, a small opaque plate of any substance is interposed in the course of the pencil of solar light admitted into a darkened room through a very small hole in a card, or diverging from the point at which it has been collected by a convex lens of short focus, the shadow thrown by it on the screen will be surrounded by a series of colored fringes, and the shadow itself will be larger than the geometrical shadow.—But, further, if a piece of glass be ruled by a diamond with parallel lines, some hundreds or thousands to an inch, so as to form what is called a ‘grating,’ and the narrow beam proceeding from the slit be looked-at through this grating (so held that the direction of its lines is parallel to that of the slit), a number of spectra come into view, ranged at nearly equal distances on both sides of the slit.<sup>2</sup> Now, it is manifest that when a beam of light is made to pass through an object that is being examined Microscopically, the light and shade in the picture seen by the eye must be occasioned by the greater or less transparence of the different parts of that object; and that, wherever there are definite lines or margins sufficiently opaque to throw a definite shadow, such

FIG. 116.

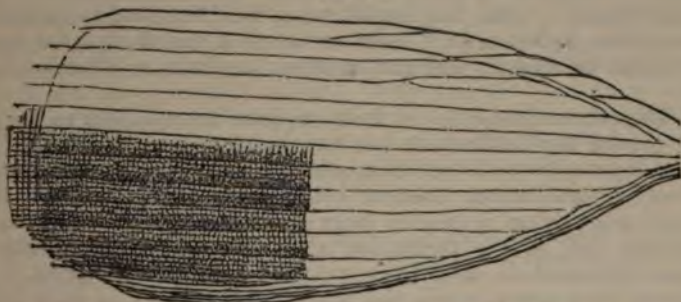
Scale of *Gnat* showing beaded markings; photographed by Dr. Woodward.

shadow must be bordered more or less obviously by ‘interference’ or ‘diffraction’ spectra, especially in the case of objects having strongly-marked lines with very transparent intermediate spaces. There are many objects of great delicacy, in which ‘diffraction-bands’ are liable to be mistaken for indications of actual substance; whilst, on the other hand, the presence of an actual substance of extreme transparence may sometimes be doubted or denied, through its image being attributed to diffraction. No rules can be given for the avoidance of such errors; since they can only be escaped by the discriminating power which education and habit confer on the experienced Microscopist.—A good example of this kind is afforded by the minute beading presented in the scales of the *Gnat* and *Mosquito* (Fig. 116). These scales are composed of a very delicate double membrane, strengthened by longitudinal ribs on either side, those

<sup>1</sup> The colors of thin plates,—as seen when the sun shines on a soap-bubble or on a film of oil spread out over a surface of water—or when we look at a window through two glasses separated by an attenuated film of air,—are familiar examples of ‘interference-fringes,’ which, when displayed annularly, are known as ‘Newton’s rings.’

<sup>2</sup> Such ‘gratings’ are now much used in Spectroscopic observation; and afford the best means of determining the wave-lengths of the rays of the several parts of the spectrum.



of the opposite sides uniting at the broad end of the scale, where they generally project as bristle-like appendages beyond the intermediate membrane; and they are crossed transversely by fine markings, which are probably ridge-like corrugations of their membrane, these also existing on both surfaces of the scale. The attention of Dr. Woodward having been drawn by Dr. Anthony to the presence in these scales of *three uniform parallel rows of beads in every interspace between two adjoining ribs*, he was at first inclined to believe that the markings are real, representing an actual structure in the scale; but having obtained an excellent Photograph of it by monochromatic sun-light, under a power of 1,350 diameters, he was led to alter his opinion, and to regard them as produced by the crossing of the transverse markings by *longitudinal diffraction-lines, conditioned by the longitudinal ribs and parallel to them.*<sup>1</sup> His chief reasons for so regarding them were (1), that "the longitudinal diffraction-lines are clearly seen alike in the Microscopic image and in the Photographs, to extend into empty space beyond the contour of the scales, almost as far as the ends of the bristles in which the parallel ribs terminate;" and (2), "that they vary in number with varying obliquity of illumination, so that in the same scale two, three, four, and five rows of beads can be seen, and photographed at pleasure, in every intercostal space." The true appearance, Dr. Woodward considers, is given when the Achromatic Condenser is so adjusted that its light is either central or slightly oblique in the longitudinal direction of the scale.

157. The recent researches of Prof. Abbe of Jena appear to have conclusively proved that Diffraction has a most important share, previously altogether unsuspected, in the formation of the Microscopic images of very closely approximated lines or other markings, in objects viewed under high magnifying powers of large Angular aperture.—All that has been hitherto said of the formation of Microscopic images, relates to such as are produced, in accordance with the laws of *refraction*, by the alteration in their course which the Light-rays undergo in their passage through the lenses interposed between the object and the eye. These *dioptric* images, when formed by lenses free from Spherical and Chromatic aberration, are *geometrically correct pictures*, truly representing the appearances which the objects themselves would present, were they enlarged to the same scale, and viewed under similar illumination. And we are fully justified, therefore, in drawing from such Microscopic images (provided that they are free from diffraction-spectra) the same conclusions in regard to the structure of the objects they picture, as we should draw from the direct vision of actual objects having the same dimension. There is, however, an optical limit as to the completeness of such images in regard to minute detail; as it appears from the theoretical researches of Profrs. Helmholtz and Abbe, that no amount of magnifying power can separate *dioptrically* two lines, apertures, or markings of any kind, not more than 1-2500th of an inch apart. The visual separation or 'resolution' of more closely approximated lines or other markings is entirely the result of *diffraction*; the Objective receiving and transmitting, not only the ordinary dioptric rays, but the 'inflected' rays whose course has been altered in their course *through* the object by some peculiarity in the disposition of its particles. These rays, when acted-on by the Objective, produce 'diffraction-spectra;' the number and relative position of which

---

<sup>1</sup> "Monthly Microsc. Journ.," Vol. xv. (1876), p. 253.

bear a relation to the structural arrangement on which their production depends. If the Objective be perfectly corrected, and all the diffraction-spectra lie within its field, they will be re-united by the Eye-piece to form a secondary or 'diffraction' image, lying in the same focal plane with the dioptric image, and coinciding with it, while filling up its outlines by supplying intermediate details. But where the markings (of whatever nature) are so closely approximated as to produce a wide dispersion of the interference-spectra, only a part of them may fall within the range of the Objective; and the re-combination of these may produce a diffraction-image differing more or less completely (perhaps even totally) from the real structure; whilst, if they should lie entirely outside the field of the Objective, no secondary or diffraction-image will be produced. Thus, whilst the dioptric image represents the actual object, a diffraction-image formed by the reunion of some of the interference-spectra is only an optical expression of the result of their partial re-combination, which may represent something entirely different from the real structure;—the *same* arrangement of lines (for example) being presented to the eye by *differently*-lined surfaces, and *different* arrangements by *similarly*-lined surfaces, according to the numbers and positions of the re-united spectra.<sup>1</sup>—This doctrine, originally based on elaborate theoretical investigations in connection with the 'Undulatory Theory of Light,' has been so fully borne out by experimental inquiries instituted to test it, and is in such complete harmony with the most certain experiences of Microscopists, that its truth scarcely admits of doubt. Although any attempt to explain its theory in a Treatise like the present must necessarily be altogether futile, yet a selection from the experiments by which Prof. Abbe has verified it, will not only assist in the comprehension of the doctrine, but will enable every Microscopist to satisfy himself of their correctness.

A 'grating' should be provided, ruled alternately with long and with short lines, as in Fig. 117, A; the lines being traced with a diamond point on a film of silver of extreme tenuity deposited on a thin glass-cover; and the ruled surface being cemented to an ordinary glass slide with Canada balsam.<sup>2</sup> The 'adapter' ordinarily used for rotating the analyzing prism of the Polariscope between the Objective and the Microscope-body, should be fitted with a small tube for the introduction of diaphragms with varied slits, so that these may be rotated immediately behind the back combination of the Objective.—The 'grating' being placed on the Stage of the Microscope, illuminated from the mirror, and focussed under a 1-inch Objective, so as to show the ordinary microscopic image of its ruled surface as at A, the eye-piece is removed, and the observer, looking into the body of the instrument, and changing the place of his eyes, sees two rows of spectra, each having a central circle, with ovals on either side of it (C). The central circle is bright and colorless; while each of the ovals shows the colors of the solar spectrum, with the blue always towards the centre. These ovals are 'diffraction-spectra,' of which the four closely approximated pairs in the *upper* row are formed by the *wider* lines of the single ruling, and the two pairs in the *lower* row (which are at double the distance of the preceding) by the *closer* lines of the double ruling.

The following experiments show (1) that the dioptric image, when viewed by the eye-piece separately from all diffraction-spectra, gives no Microscopic repre-

<sup>1</sup> The reader may, perhaps, be aided in comprehending Prof. Abbe's doctrine by the following analogy:—When a solar spectrum is projected by a prism on a white surface, its entire re-combination by a convex lens will reproduce a beam of white light. But, if only certain parts of the spectrum be thus recombined, the beam will have a color dependent upon the selection.

<sup>2</sup> In the grating used by Mr. Stephenson ("Monthly Microsc. Journ.," Vol. xvii., p. 83), the lines in the upper half were about 1,790 to the inch, and in the lower about 3,580.

sentation at all of the lined surface; whilst (2) by varying the combinations of the diffraction-spectra, the lination shown in the Microscopic image of the ruled surface may be partially or completely changed.

*Experiment 1.*—If, in the first place, a diaphragm with a single diametric slit (B) be so placed immediately behind the Objective, that the slit is *parallel* to the

FIG. 117.

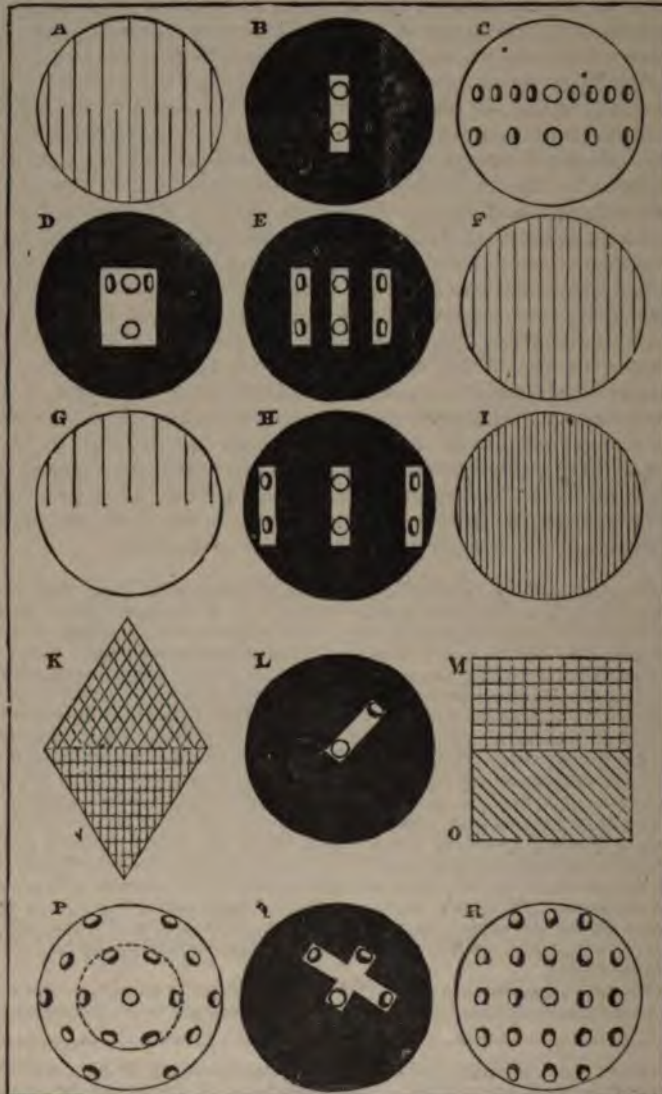

direction of the ruled lines—thus giving passage to the direct rays forming the dioptric image, but excluding all diffraction-spectra—the field seen through the replaced eye-piece shows *no lination whatever*, the 'grating' being replaced by a plain silver band. Yet, if the diaphragm be turned a quarter round, so that the slit lies *transversely* to the lines, and admits the pairs of diffraction-spectra in



each row that lie nearest the centre, *the delineation reappears, as if actually in the grating.*

*Experiment 2.*—If, now, a diaphragm be used having three slits (E), of which the central admits the direct rays only, while the two lateral receive the *first* pair of the wider spectra and the *second* pair of the closer, it will be found, on replacing the eye-piece, that the *whole field is covered with the closer lines*, as at F. For the stopping-out of the alternate spectra of the upper series brings into combination only that pair which corresponds with the lower, and therefore makes the *apparent* lineation of the upper half correspond with the *real* lineation of the lower, by the *introduction of an intermediate set of spectral lines*, scarcely distinguishable from those of which they seem to be prolongations.

*Experiment 3.*—Further, by carrying the two lateral slits (as at H) to the distance of the extreme spectra of both rows—which distance represents that of the spectra that would be produced by a lineation *twice* as close as that of the lower half of A, and *four times* as close as that of the upper half—the entire field, when the eye-piece is replaced, is seen to be *covered with the doubly-close lines* corresponding to that distance, as shown at I.

*Experiment 4.*—On the other hand, by using a single aperture shaped as in D, which is broad enough to admit the innermost pair of spectra in the upper row, but not to admit any of the spectra of the lower row, the field, when the eye-piece is replaced, shows the wide lines (G) of the upper half of the grating, whilst *its lower half is perfectly blank.*

It has thus been experimentally demonstrated that the formation of the true image of the grating is dependent upon the normal re-combination of its diffraction-spectra, while the entire exclusion of these altogether obliterates the lineation. And we thus have now for the first time the scientific rationale of the fact which has long been practically known—the relation of the ‘resolving power’ of Objectives to their Angle of aperture. For it is obvious that since the ‘inflected’ rays which form the ‘diffraction-spectra’ diverge more and more widely in proportion to the approximation of the lines that separate them—so that those spectra (as already shown) are carried apart to greater and yet greater distances—the separation of those of a very close lineation may be such as to carry them completely beyond the aperture of an Objective which may take in the spectra of a more open lineation (Exper. 4). And thus an Objective may be able clearly to separate lines of 50,000 to an inch, from which no amount of ‘coaxing’ by oblique or any other kind of illumination can obtain a resolution of lines of 80,000 to an inch.—But further, it has been made clear that most distinct ‘spectral’ lines can be produced in the Microscopic image, by the re-combination of selected pairs of diffraction-spectra, without any real lines answering to them; and hence, that the images thus formed cannot be regarded as indicative of the actual structure of the objects they represent; the grating, for example, whose real lineation is shown at A, being made to appear (according to the manner in which it is viewed) either entirely blank, as half-blank (G), as having the intermediate lines of its lower half extended over its upper (F), or as having its whole field covered with lines at only half the distance of those of its closest part (I). The same effects of obliteration or duplication of lines may be produced on such objects as the scale of *Lepisma saccharina* (Fig. 417), by using higher powers with suitable diaphragms.—It will now be shown that the variations producible by similar treatment in the appearances of *cross-lined* objects, are yet more remarkable.

A grating with lines crossed at an angle may be prepared by cementing a cover-glass, with one set of lines ruled through a silver-film on its under side, upon a glass slide having another set ruled on a silver-film on its upper surface. If the two sets of lines are placed at right angles to each other, a rectangular grating is the result (N); if at any oblique angle, the grating is rhombic (K).



If the square grating be focussed, and its image examined by looking into the tube of the Microscope without the eye-piece, the diffraction-spectra will exhibit the regular arrangement shown at R: the round image being in the centre of the field, and the ovals being disposed in five rows at equal distances.

Experiment 5.—A diaphragm being interposed (L) with an oblique slit just large enough to admit the central circle and one of the diffraction spectra, and the eye-piece being replaced, the real rectangular lines will not be seen at all, but the field will be traversed by oblique spectral lines (O), whose direction is at right angles to that of the slit.

The image of the rhombic grating be examined in the same manner as that of the square, and will exhibit the arrangement shown at P (the dotted inner circle being the central image).

Experiment 6.—By using a diaphragm with a single slit in the direction of one of the diameters of the rhombic grating, a Microscopic image will be presented from which the rectangular lines are completely absent, whilst a single set of spectral lines is seen, whose direction is at right angles to the slit, that is, in the direction of the other diameter.

Experiment 7.—By using a diaphragm with two slits at right angles to each other, the Microscopic image will show two sets of spurious lines crossing each other at right angles, &c. in the directions of the two diameters of the rhombic grating, being altogether invisible.

Experiment 8.—The same angular effect is produced by the use of a single circular diaphragm, if the aperture is reduced so as only to include the six spectral lines of the central image at P: for on then replacing the eye-piece, the Microscopic image will exhibit a hexagon.

Now, if the rhombic grating be focussed with central illumination, and the objective of sufficiently high power and large aperture, and the eye-piece removed, there will be seen on looking down the body a bright central circle, and six spectra arranged round it—just as in the interior of the tube of the rhombic grating: the reason that no other spectra are seen, is, that the approximation of the markings carries these six spectra to the very margin of the field of even the largest-angled Objective. An Objective of such power will not show them at all with central light; but if oblique light be used, the central beam is carried to one margin, and a single spectral oval is seen at the other, and the recombination of these suffices to make one set of lines visible. And, by recombining, by means of appropriate diaphragms, any three of the spectral ovals, or any two of these with the central beam, the very same variety of appearances may be made to show a great variety of appearances—such as may be seen in different parts of the same valve under the same illumination (Fig. 10).

The foregoing experiments, then, entirely confirm the general conclusions drawn from those of the previous series, (1) as to the entire difference in character between the images Dioptrically formed of the fine lines and larger details of Microscopic objects, and the appearances of their finer details which result from the reunion of the diffraction spectra; and (2) as to the very limited trustworthiness of the former, when the minuteness of the structure occasions such a wide separation of the 'diffraction-spectra,' as limits the number thus combined. It thus becomes clear (1) that the 'resolving power' by which the approximated lines or other markings are separated, increases with the closeness of the corrections for Spherical and Chromatic aberrations (or, decomposed) with the Angular Aperture of the Objective;

See the original Memoir by Prof. Abbe, 'Beiträge zur Theorie des Microscop,' in 'Archiv für Microscop. Anatomie,' Bd. ix. (1874), p. 418; Dr. H. E. Sarsland's translation of it in the "Proceedings of the Bristol Naturalists' Society," Vol. v. (part 1881), extracts from Dr. F.'s translation in "Monthly Microsc. Club," Vol. xiv. (1879), pp. 191, 245; also Mr. Stephenson's 'Observations' on the subject in the Author has been specially indebted—*op. cit.*, Vol. xvii. (part 1881), and Mr. P. Cusp "On the Influence of Diffraction in Microscopic Vision," in "Annals of the Quakett Club," Vol. v., p. 79.

The term *Angular Aperture* is to be understood as differentiated from "Angle of Aperture" (p. 10), by the allowance made for the modification in the course of

and (2) that, as there is a like increase in the number of separate diffraction spectra which can be combined with the dioptric image, the representations of minute structure given by Objectives of widest Angular aperture are more trustworthy than those given by those of narrower.

158. *Relative Qualities of Objectives.*—In estimating the comparative values of different Objectives, regard must always be had to the *purpose* for which each is designed; since it is impossible to construct a combination which shall be equally serviceable for *every* requirement. It is commonly assumed that an Objective which will show certain *Test-objects*, must be very superior for everything else to a glass which will not resolve these; but this is known to every practised Microscopist to be a complete mistake, the qualities which enable it to resolve some of the more difficult 'tests,' not being by any means identical with those which make it most useful in all the ordinary purposes of Scientific investigation. Five distinct attributes have to be specially considered in judging of the character of an Object-glass, viz.—(1) its *working-distance*, or actual interval between its front lens and the object on which it is focussed; (2) its *defining power*, or power of giving a clear and distinct image of all well-marked features of an object, especially of its boundaries; (3) its *penetrating power*, or *focal depth*, by which the observer is enabled to *look into* the structure of objects; (4) its *resolving power*, by which it enables closely-approximated markings to be distinguished; and (5) the *flatness of the field* which it gives.

I. The 'Working distance' of an Objective has no fixed relation to its 'focal length;' the latter being estimated by its equality in magnifying power with a single lens of given curvature; while the former varies with the mode in which the combination is constructed, and with the angular aperture given to it. Of two Objectives of 1-inch focus and the same angle of aperture (say  $25^\circ$ ), one may have, in virtue of its construction, a much longer 'working distance' than the other; and this is not only an advantage in facilitating the side-illumination of opaque objects, but also in admitting (as will presently appear) of greater 'focal depth' or 'penetration.' But it is especially in the case of high powers that 'working distance' comes to be of essential importance. The widening of angular aperture which is required to give them their highest degree of 'resolving' power (IV.) necessitates a very close approximation of the front lens to the object; and whilst it is an absolute necessity that the interval should be sufficient for the interposition of a cover of the thinnest glass, or (if this be inadmissible) of a film of mica, every addition to this interval is a clear gain, not only in convenience of working, but also in regard to the 'penetrating' power (III.) of the Objective.—The increase of 'working distance' obtainable by the use of the Immersion system is by no means the least of its advantages.

II. The 'Defining power' of an Objective depends upon the *completeness of its corrections* for Spherical and Chromatic aberration (§§ 9–

---

the rays, by the medium—whether Air, Water, Glycerine, Balsam, or Oil—through which they pass in their course from the object into the Objective. (See Appendix.)

Owing to the want of some common standard, Objectives constructed by different Makers of the same *nominal* focal length, often differ considerably from each other in magnifying power; and the proportional amplification given by the different Objectives of any one Maker's series is often very different from that indicated by their nomenclature. It is therefore greatly to be wished that some uniform standard could be agreed on; such as that of Magnifying power under an Eye-piece of definite focal length, at a fixed distance from the Objective.



15), especially the former; and it is an attribute essential to the satisfactory performance of *any* Objective, whatever be its other qualities. Good definition may be more easily obtained with lenses of *small* or *moderate*, than with lenses of *large* angular aperture; and as it is impossible to construct 'dry' Objectives of very wide angle, without some sacrifice of perfect correction (Abbe), there is a limit which, where 'definition' is of primary importance, cannot be advantageously passed. On the immersion system, however, and especially on the 'homogeneous immersion' system (§§ 19, 20), Objectives can be constructed of very much wider angle, without any injurious sacrifice of definition arising from inadequate correction. But here there comes in another source of impairment—the *difference in the perspective views of every object not a mere mathematical point or line, which are received through the different parts of the area of the Objective*. The picture given by the entire area is—so to speak—the 'general resultant' of the dissimilar pictures received through these several parts; and as this dissimilarity obviously increases with the angle of aperture of the Objective, its defining power *must* be proportionately impaired. This theoretical conclusion has been experimentally verified by Dr. Royston Pigott; who has found that by comparing Objectives of *large* with those of *moderate* apertures, on such objects as the cracks in Mr. Slack's silica-films (§ 152), or the aerial image formed by the Achromatic Condenser of a hair stretched before the light at some distance, the advantage was *decidedly on the side of the latter*. He has shown<sup>1</sup> "that the black margins or black marginal annuli of refracting spherules constantly displayed by small aperture Objectives, are attenuated gradually to invisibility as the apertures are widened to the utmost; that the black margins of cylinders, tubules, or semi-tubules, also suffer similar obliterations; and that, in consequence, *minute details are concealed or destroyed till the aperture is sufficiently reduced*."—It is also the experience of Messrs. Dallinger and Drysdale, that for the definition of the immeasurably-minute reproductive granules of the *Monadine* forms whose life-history they have studied (§ 418), or of the flagella of *Bacterium termo* (§ 305), which may be characterized as the highest feats of Biological Microscopy yet performed, *moderate* angles of aperture are unquestionably to be preferred (VI.)—An experienced Microscopist will judge of the defining power of an Objective by the quality of the image it gives of any fitting object with which he is familiar; no test being, in the Author's judgment, more suitable than the *Podura*-scale (§ 162). Any imperfection in Defining power is exaggerated, as already pointed out (§§ 26, 136), by 'deep Eye-piecing;' so that, in determining the value of an Objective, it is by no means sufficient to estimate its performance under a low Eye-piece—an image which appears tolerably

<sup>1</sup> This point has been long kept before the mind of the Author, by his studies in Stereoscopic Microscopy; the condition of the effect of *relief* in the Binocular image being the *dissimilarity* of the pictures of any object not absolutely flat, that are formed by the right and the left halves of the Objective respectively (§ 39). And he is glad to find his view of its importance confirmed by so able a practical Optician as Mr. Zentmayer; who, in a Lecture on the Elementary Properties of Lenses, published in the "Journal of the Franklin Institute" for May and June, 1876, and cited in the "Monthly Microscop. Journ.," Vol. xvi. (1876), p. 317, called attention prominently to the *confusion of images necessarily attendant upon large apertures, except when viewing absolutely flat objects*, from the fact that the image formed by pencils transmitted by one side of the lens are unavoidably different from corresponding images formed by the opposite side of the lens.

<sup>2</sup> "Proceeding of Royal Society," June 19th, 1879.

clear when moderately magnified, being often found exceedingly deficient in sharpness when more highly amplified. The use of the Draw-tube (§ 83) affords an additional means of testing the Defining power; but recourse cannot be fairly had to this, unless an alteration be made in the adjustment for the thickness of the glass that covers the object (§ 139), in proportion to the nearer approximation of the object to the Objective which the lengthening of the body involves.

III. The Penetrating power or 'focal depth' of an Object-glass may be defined as consisting in the *vertical range* through which the parts of an object *not precisely in the focal plane* may be seen with sufficient distinctness to enable their relations with what *does* lie precisely in that plane to be clearly traced out; just as we could do by ordinary vision, if the object were itself enlarged to the size of its Microscopic image.—Now this is a quality which is very differently valued by different observers, according to the nature of the work on which they may be severally engaged. The Histologist who is scrutinizing the elementary components of a tissue that is spread out in the thinnest possible film between two plane surfaces of glass, considers 'penetration' rather an evidence of *imperfection* in his Objective, which (he affirms) cannot show him anything save what is *exactly* in the focal plane, without a sacrifice of its highest attainable capacity for doing the latter. On the other hand, the Anatomist who is studying the general organization of some minute Plant or Animal, or the structure of individual organs in a larger one, finds a certain amount of 'penetration' essential to his recognition of the *relations* between the several parts of the object which are successively brought into distinct views by alterations of the focal adjustment. And the Physiologist who is watching the *actions* that are going on in a living Organism or in some component part of it (as, for example, the internal movements of an *Amœba*, or the *cyclosis* in a leaf-cell of *Vallisneria*) could form no satisfactory conception of such phenomena, if, instead of passing gradationally (as an Objective of good 'penetration' allows him to do) from one focal plane to another, he can only get a series of 'dissolving views' with an interval of 'chaos' between each, as he does when working with an Objective whose 'penetration' has been sacrificed to Angular aperture.—For the study of *opaque* objects which present such inequalities of surface as to render it impossible to apprehend their true forms unless much more can be seen than is precisely in focus at once, good 'penetrating' power is obviously essential; and this is indispensable to the advantageous use of the Stereoscopic Binocular, which grossly exaggerates the effect of *projection*, when objects are viewed under Objectives of too wide an angle (§ 39).—No definite rule can be laid down as to the relation which the 'focal depth' of an Objective bears to its 'working distance' and its 'angular aperture;' because much depends upon the mode of their construction. But it may be stated generally that Objectives of longest working distance have the greatest 'penetration;' whilst the widening of the Angular aperture diminishes penetration at a rapidly increasing rate.<sup>1</sup>

<sup>1</sup> The Author is informed by Prof. Abbe, that, theoretically—the plan of construction remaining the same—the 'penetration' of an Objective decreases, as the square of the Angular aperture increases.—It is perfectly well-known to Photographers, that a good picture of the interior of a long Sculpture-gallery, showing both the near and the distant parts with tolerable distinctness, can only be obtained by a lens of *very* narrow angle.—The singular assertion lately made by Dr. Blackham ("On Angular Aperture of Objectives," New York, 1880), that



iv. The 'Resolving power' by which very minute and closely approximated markings—whether lines, striæ, dots, or apertures—are separately discerned, has now been clearly shown to depend upon Angular aperture (§ 157); and this, not so much—as formerly supposed—on account of the greater obliquity of the rays which large-angled Objectives will admit, as because of their capacity to receive and recombine the 'diffraction-spectra' that lie without the range of Objectives of more limited angle. In comparing the 'resolving' powers of different Objectives, it must be borne in mind that the advantages of wide aperture will be lost, if the obliquity of the illumination does not correspond with that of the most divergent rays which enter the Objective to take part in the formation of the image. But when the question is not of the resolution of surface-markings (such as those of Diatom-valves), but of the determination of internal structure (as, for example, in the study of the process of division in cell-nuclei), axial illumination is decidedly to be preferred, as being attended with less liability than oblique to produce deceptive appearances.—It appears from the theoretical researches of Prof. Abbe, that the *maximum* attainable resolving power with an Angular aperture of  $180^\circ$  should separate 118,000 lines to the inch; and this agrees well with what has been actually accomplished (§ 160). But the loss of 'resolving' power consequent upon the contraction of the aperture from  $180^\circ$  to  $128\frac{1}{2}^\circ$  is only 10 per cent.; while a further reduction to  $106\frac{1}{4}^\circ$  only lowers the number of separable lines to 94,400 per inch.

v. The 'Flatness of the field' afforded by the Object-glass is a condition of great importance to the advantageous use of the Microscope, since the real extent of the field of view practically depends upon it. Many Objectives are so constructed, that, even with a perfect flat object, the foci of the central and of the peripheral parts of the field are so different, that when the adjustment is made for one, the other is extremely indistinct. Hence, when the central portion is being looked at, no more information is gained respecting the peripheral, than if it had been altogether stopped out. With a really good Object-glass, not only should the image be distinct even to the margin of the field, but the marginal portion should be as free from color as the central. In many microscopes of inferior construction, the imperfection of the Objectives in this respect is masked by the contraction of the aperture of the diaphragm in the Eye-piece (§ 27), which limits the dimensions of the field; and the performance of one Objective within this limit may scarcely be distinguishable from that of another, although, if the two were compared under an Eye-piece of larger aperture, their difference of excellence would be at once made apparent by the perfect correctness of one to the margin of the field, and by the entire failure of the other in every part save its centre. In estimating the relative merits of two lenses, therefore, as regards this condition, the comparison should be made under an Eye-piece giving a large field.

vi. The most perfect objective for general purposes, is obviously that which combines *all* the preceding attributes in the degree in which they are mutually compatible. But it seems to be now clear that the highest perfection of the two primary qualities, 'defining' power and 'resolving

---

'depth of focus' has no relation to Aperture, but depends on "residual" (i. e., uncorrected) Spherical Aberration, and that "the less the lens has of it, the better the lens," does not require serious refutation.

power,' cannot be obtained in the same combination; so that the choice between two Objectives, one distinguished by the former of these attributes, and the other by the latter, will depend upon the kind of work on which it is to be employed. If the resolutions of the markings on Diatom-valves is the Microscopist's special pursuit,<sup>1</sup> he will rightly prefer an Objective of the largest attainable angle, with the best definition that is compatible with it. But if he be engaged upon difficult Biological investigations, he will do well to make perfect 'definition' his *sine qua non*, and to be content with the largest angle that can be obtained without a sacrifice of this. It is, as already stated, in admitting of perfect correction for Spherical Aberration, even to an aperture of  $180^\circ$ , that the great superiority of the 'immersion system' consists; but the greatest perfection in the construction of even an immersion Objective, cannot (in the nature of things) prevent that impairment of definition, which has been experimentally as well as theoretically shown by Dr. Royston Pigott to be consequent upon excessive widening of the angle of aperture. The most serviceable Objectives for the most difficult Biological investigations, therefore, will (in the Author's judgment) be such as possess the combination of qualities attributed by Mr. Dallinger to the 1-35th inch constructed specially for his work by Messrs. Powell and Lealand; "the angle is moderate; its definition very crisp and clear; and its penetration, considering its magnifying power, very considerable."

159. *Test-Objects*.—It is usual to judge of the optical perfection of a Microscope by its capacity for exhibiting certain objects, which are regarded as *Tests* of the merits of its Object-glasses; these tests being of various degrees of difficulty, and that being accounted the best instrument which shows the most 'difficult' of such tests. Now it must be borne in mind that of the qualities which have been just enumerated, the 'tests' usually relied-on have reference almost exclusively to two—viz., *definition* and *resolving power*; and that the greater number of them, being objects whose surface is marked by lines, striæ, or dots, are tests of *resolving power*, and thus of Angular aperture only. Hence, as already shown, an Objective may resolve some very difficult *test-objects*, and yet may be very unfit for ordinary use. Moreover, these 'difficult' tests are only suitable to Object-glasses of very short focus and high magnifying power; whereas the greater part of the real *work* of the Microscope is done with Objectives of low and medium power; and the enlargement of the Angular aperture, which enables one of these to re-

<sup>1</sup> It is assuredly neither the *only* nor yet the *chief* work of the Microscope (as some appear to suppose) to resolve the markings on the siliceous valves of *Diatoms*; in fact, the interest which attaches to observations of this class is entirely confined to the value of these objects as 'tests' of the performance of Objectives (§ 159). If one-tenth of the attention which has been devoted to the scrutiny of these objects with instruments of the highest class, had been given to the study of the Life-history of the minute Plants which furnish them, with such a Student's microscope as thirty years ago enabled Mr. Thwaites to discover their 'conjugation,' it cannot be doubted that vast benefit would have accrued to Biological Science.—It has been urged that the acquirement of the power of displaying 'difficult' Diatom-tests, is a valuable 'gymnastic' for the training of Microscopists; but the experience of the Author, and of every Biological teacher he knows, is that a much better training for the Student is to begin with the study of such easy objects—e. g., the Yeast-Plant, and Colorless Blood-Corpuscles,—as afford him the experience which it is absolutely essential that he should acquire in the first instance, and to proceed gradually from these to the more difficult, gaining new knowledge at every stage.

solve (under deep Eye-pieces) many objects which were formerly considered adequate tests for higher powers, is *for ordinary purposes* rather injurious than beneficial, detracting from the value of the Objective for the work to which it is specially adapted. For Microscopists of large Biological experience know perfectly well that every 'power' has its own proper range and capacity; and that they work most satisfactorily with the 'power' most suitable to the investigation on which they may be engaged. In estimating the value of an Object-glass, it should always be considered *for what purpose it is intended*; and its merits should be judged-of according to the degree in which it fulfils that purpose. We shall therefore consider what are the objects proper to the several 'powers' of Object-glasses—*low, medium, and high*; and what are the objects by its mode of exhibiting which, each may be fairly judged.

I. By Objectives of *low* power we may understand any whose focal length is *greater than Half-an-inch*. The 'powers' usually made in this country are known as 4 inch, 3 inch, 2 inch,  $1\frac{1}{2}$  inch, 1 inch, and 2 3ds inch focus; and they give a range of amplification of from 10 to 70 diameters with the A eye-piece, and of from 16 to 120 diameters with the B eye-piece. An 'adjustable' low power is made by Zeiss of Jena (obtainable from Messrs. Baker), in which, by varying the position of the front-lens by means of a screw-collar, a *range* of power is obtainable from about 8 to 16 diameters with the A eye-piece, and from 12 to 24 with the B eye-piece. This has been found by the Author extremely convenient for the display of large opaque objects, of which it is desired to show the whole under as high an amplification as will make their images fill the field. Objectives of *low* power are most used in the examination of opaque objects, and of Transparent objects of large size and of comparatively coarse texture; and the qualities most desirable in them are a sufficiently large aperture to give a *bright* image, combined with such accurate definition as to give a *clear* image, with 'focal depth' sufficient to prevent any moderate inequalities of surface from seriously interfering with the distinctness of the entire picture, and with perfect 'flatness' of the image when the object itself is flat. For the 3 inch, 2 inch, or  $1\frac{1}{2}$  inch Objectives,<sup>1</sup> no ground of judgment is better than the manner in which it shows such an injected preparation as the interior of a Frog's Lung (Fig. 485) or a portion of the villous coat of the Monkey's Intestine (Fig. 479); for the aperture ought to be sufficient to give a bright image of such objects by ordinary daylight, without the use of any illuminator; the border of every vessel should be clearly defined, without any thickness or blackness of edge; every part of such an object that comes within the field should be capable of being made-out when the focal adjustment is adapted for any other part; whilst, by making that adjustment a medium one, the whole should be seen without any marked indistinctness. If the Aperture be too small, the image will be dark: but if it be too large, details are brought into view (such as the separateness of the particles of the vermilion injection) which it is of no advantage to see; whilst, through the sacrifice of penetration, those parts of the object which are brought exactly into focus being seen with over-minuteness, the remainder are enveloped in a thick fog through which even their general contour can scarcely be seen to loom. If the corrections be imper-

<sup>1</sup> These are ordinarily composed of *two pairs* of lenses only, as the corrections can be adequately made by this combination for an Angular aperture of  $23^\circ$ , which is the largest that is found practically useful for the  $1\frac{1}{2}$  inch.

fectly made, no line or edge will be seen with perfect sharpness. For Defining power, the Author has found the Pollen-grains of the Holly-hock or any other flower of the *Mallow* kind (Fig. 277, A) viewed as an opaque object, a very good test; the minute spines with which they are beset being but dimly seen with any save a *good* Object-glass of these long foci, and being really-well exhibited only by adding such power to the Eye-piece, as will exaggerate any want of definition on the part of an inferior lens. For Flatness of field no test is better than a section of Wood (Fig. 253) or a large Echinus spine (Fig. 369), under an Eye-piece that will give a field of the diameter of from 9 to 12 inches. The general performance of Object-glasses of 1-inch and 2-3ds inch focus, may be partly judged-of by the manner in which they show such injections as those of the Gill of the Eel (Fig. 484), or of the Bird's Lung (Fig. 486), which require a higher magnifying power for their resolution than those previously named; still better, perhaps, by the mode in which they exhibit a portion of the wing of some Lepidopterous Insect having well marked scales. The same qualities should here be looked-for, as in the case of the lowest powers; and a want of either of them is to be distinguished in a similar manner. The increase of Angular aperture which these Objectives may advantageously receive up to 30°, should render them capable of resolving all the easier 'test' scales of Lepidoptera, such as those of the *Morpho menelaus* (Fig. 414), in which, with the B eye-piece, they should show the transverse as well as the longitudinal markings. The Proboscis of the Blow-fly (Fig. 428)<sup>1</sup> is one of the best transparent objects for enabling a practised eye to estimate the general performance of Object-glasses of these powers; since it is only under a really good lens, that all the details of its structure can be well shown. In particular, all the outlines and edges should be seen clearly and sharply, without any haze or fringe; the tracheal spires and rings should be well-defined, without any color between them; and there should be no indication of general mist. An Objective which shows *this* well, may be trusted for any other object of its kind. For Flatness of field, sections of small Echinus-spines (Plate II., fig. 1) are very good tests. The exactness of the corrections in lenses of these foci may be judged-of by the examination of objects which are almost sure to exhibit Color if the correction be otherwise than perfect. This is the case, for example, with the so-called *glandulae* of Coniferous wood (Fig. 248), the centres of which ought to be clearly defined under such objectives, and to be quite free from color; and also with the *tracheae* of Insects (Fig. 432), the spires of which ought to be distinctly separated from each other, without any appearance of intervening chromatic fringes.

II. We may consider as Objectives of *medium* power the Half-inch, 4-10ths inch, 1-4th inch, and 1-5th inch; the magnifying power of which ranges from about 90 to 250 diameters under the A eye-piece, and from about 150 to 400 diameters with the B eye-piece. The first three, when used by reflected light, can be advantageously employed in the examination of such small *opaque* objects as Diatoms, Polycystina, portions of small Feathers, capsules of the lesser Mosses, Hairs, etc.; they should be so mounted on cones as to allow of side illumination; and the 1-4th should have sufficient working distance to permit its easy use for these

---

<sup>1</sup> This object should be mounted in Glycerine-jelly; for when mounted in Balsam, the parts are usually flattened-out and squeezed together, so that their real forms and relative positions cannot be seen.



purposes, with an aperture not exceeding  $80^\circ$ . Larger-angled 1-4ths and 1-5ths cannot be conveniently used for opaque objects, unless these are shown by Prof. Smith's or some analogous illumination (§ 116).—The great value of these powers lies in the information they enable us to obtain regarding the details of organized structures and of living actions, by the examination of properly-prepared *transparent* objects by transmitted light; and it is to them that the remarks already made respecting Angular aperture (§ 158, II.) especially apply; since it is here that the greatest difference exists between the ordinary requirements of the Scientific investigator, and the special needs of those who devote themselves to the particular classes of objects for which the greatest 'resolving' power is required. A moderate amount of such power is essential to the value of every Objective within the above-named range of foci: thus, even a good half-inch should enable the markings of the larger scales of the *Polyommatus argus* ('azure-blue Butterfly') to be well distinguished—these being of the same kind with those of the Menelaus, but more delicate—and should clearly separate the dots of the small or 'battledoor' scales (Fig. 416) of the same Insect, which, if unresolved, are seen as coarse longitudinal lines; a good 4-10ths inch should resolve the larger scales of the *Podura* (Plate II., fig. 2) without difficulty; and a good 1-4th or 1-5th-inch should bring out the markings on the smaller scales of the *Podura*, and should resolve the markings on the *Pleurosigma angulatum* into lozenge-lines, the B and C eye-pieces being used when the scales are very small and their markings delicate. Even the half-inch or the 4-10ths inch *may* be made with angles of aperture sufficiently wide to resolve the objects named as difficult tests for the powers above them;<sup>1</sup> but for the reasons already stated, the Author thinks it most undesirable that they should be thus *forced up* to the work altogether unsuited to their powers, by a sacrifice of those very qualities which constitute their special value in the study of the objects whereon they can be most appropriately and effectively employed. And he is decidedly of opinion that an angular aperture of  $50^\circ$  is as great as should be given to a Half-inch,  $60^\circ$  to a 4-10ths inch, and  $90^\circ$  to a 1-4th inch, that are destined for the ordinary purposes of Scientific investigation: whilst his own experience would lead him to prefer an angle of  $40^\circ$  for the Half-inch (§ 39), and of  $80^\circ$  for the 1-4th inch, provided the corrections are perfect. Objectives of these apertures should show the easier tests first enumerated, with perfect Definition, a fair amount of Penetrating power, and complete Flatness of field. No single object is so useful as the *Podura-scale* for the purpose of testing these qualities in a 1-4th inch or 1-5th inch Objective; and it may be safely said that a lens

<sup>1</sup> By Mr. Tolles (Boston, N.E.) the Angle of the half-inch is carried to  $80^\circ$ : and that of the 4-10ths to  $145^\circ$ . And it has lately been seriously maintained that an Objective of the latter focus supplies almost every need of the Biologist, since, as even difficult Diatom-tests can be shown by it, it can be worked up by deep Eye-piecing to the highest power that he requires, except for special investigations. But the resolution of a Diatom is one thing, while the prosecution of investigation continued through several hours at a time is quite another; and the Author, regarding the advice of this writer as most dangerous to the eyes of those who may follow it, deems it his duty to enter his protest against it.—Many excellent makers now make *first-class* Objectives of *narrow* as well as *wide* angles; thus, Messrs. Powell and Lealand, followed by several others, make the half-inch of  $40^\circ$  (first constructed for the Author, to be used with the Stereoscopic Binocular), as well as a half-inch of  $70^\circ$ ; Messrs. Beck make a 4-10ths of  $55^\circ$ , as well as one of  $90^\circ$ ; and Mr. Crouch a 1-4th of  $60^\circ$ , another of  $105^\circ$ , and another of  $140^\circ$ .

which brings out its markings satisfactorily will suit the requirements of the ordinary working Microscopist, although it may not resolve difficult Diatoms. In every case, the Objective should be tried with the B and C as well as with the A eye-piece; and the effect of this substitution will be a fair test of its merits. Where markings are undistinguishable under a certain Objective, merely because of their minuteness or their too close approximation, they may be enlarged or separated by a deeper Eye-piece, provided that the Objective be well corrected. But if, in such a case, the image be darkened or blurred, so as to be rather deteriorated than improved, it may be concluded that the Objective is of inferior quality, having either an insufficient Angular aperture, or being imperfectly corrected, or both.

III. All Object-glasses of less than 1.5th inch focus may be classed as *high* powers; the focal lengths to which they are ordinarily constructed being 1.6th, 1.8th, 1.10th, 1.12th, 1.16th, 1.20th, 1.25th, 1.40th, and 1.50th of an inch respectively; the 1.12th, 1.16th, 1.25th, and 1.50th being made by Messrs. Powell and Lealand, and the 1.10th, 1.20th, and 1.40th by Messrs. Beck. The magnifying powers which Objectives from 1.6th to 1.25th inch focus are fitted to afford, range from about 320 to 1250 diameters with the shallower Eye-piece, and from 480 to 1850 diameters with the deeper: but by the use of still deeper Eye-pieces, or by the Objective of 1.50th inch, or the 1.80th recently constructed by Messrs. Powell and Lealand, a power of 4000 or more may be obtained. It is seldom, however, that anything is really gained thereby.—The introduction of *immersion*-lenses (§ 19) has considerably increased the utility of what may be called moderately high powers, such as 1.8th, 1.10th, and 1.12th. These, if really good, can be used when necessary with deep Eye-pieces; and very little of scientific importance that is beyond their reach has yet been seen by higher Objectives, though the latter have, no doubt, special value in certain circumstances when skilfully employed. With these and higher powers not intended for exclusive use upon 'vexatious' Diatoms, the Angle of aperture should be so proportioned to focal length, as not to sacrifice the 'definition' and 'penetration' required to show the internal organs of small Rotifers, large Infusoria, minute Worms, etc. An Objective that will show *surfaces* only, may be broadly stated to be of little use for Biological investigation. Dry-front 1.8ths or 1.12ths with an aperture closely approaching  $170^\circ$ , are of very limited utility, from want of penetration, and from focussing extremely close to their objects; while with  $30^\circ$  to  $40^\circ$  less aperture and good corrections, they are much more serviceable, losing very little (as already shown, § 158, IV.) in 'resolving' power, and gaining much in working distance and penetration.

160. For Resolving power, the best tests are afforded by the lines artificially ruled by M. Nobert, and by the more 'difficult' Diatoms.—What is known as *Nobert's Test* is a plate of glass, on a small space of which, not exceeding one-fiftieth of an inch in breadth, are ruled from ten to nineteen series of lines, forming as many separate bands of equal breadth. In each of these bands, the lines are ruled at a certain known distance; and the distances are so adjusted in the successive bands, as to form a regular diminishing series, and thus to present a succession of tests of progressively increasing difficulty. The distances of the lines differ on different plates; all the bands in some series being resolvable under a good Objective of 1.4th inch focus, whilst the closest bands in others long defied the resolving power of 1.12th inch Objectives of large

Aperture. On the nineteen-band Test-plate the lines are ruled at the following distances, expressed in parts of a Paris line, which, to an English inch, is usually reckoned as .088 to 1.000, or as 11 to 125:—

Band 1. 1-1000th.	Band 8. 1-4500th.	Band 14. 1-7500th.
" 2. 1-1250th.	" 9. 1-5000th.	" 15. 1-8000th.
" 3. 1-2000th.	" 10. 1-5500th.	" 16. 1-8500th.
" 4. 1-2500th.	" 11. 1-6000th.	" 17. 1-9000th.
" 5. 1-3000th.	" 12. 1-6500th.	" 18. 1-9500th.
" 6. 1-3500th.	" 13. 1-7000th.	" 19. 1-10000th.
" 7. 1-4000th.		

The following exact estimates of the numbers of the lines to the English inch, of some of the Bands, are given by Dr. Royston Pigott:—

Band.	No. of spaces per inch.	Band.	No. of spaces per inch.
X.	56,297.56790.	XV.	90,076.10864.
XI.	67,557.08148.	XVII.	101,335.62222.
XIII.	78,816.59506.	XIX.	112,595.13580.

On the surface of Nobert's Test-plate, spurious diffraction lines are easily observed, and the resolution; and the difficulty of resolving the higher lines of the series was formerly supposed to be an optical impossibility. The more recent suggestions of Helmholtz and Abbe, however, have rendered this a technical objection; and the 'resolution' of Nobert's 19th band, which was long supposed to be a sort of *crux* of Microscopy, is now a well-understood fact.

It is also to be questioned that the recognition of the value of the magnifying and resolving values of the *Diatoms* as Test-objects (first made by Messrs. Harrison and Sollitt, of Hull, in 1841) has largely contributed to the success of the endeavors which have since been so effectively made, to perfect high-power Objectives, and to devise new methods of arrangement to the best advantage. But it has now been demonstrated, both theoretically and practically, that the power of 'resolving' these minute, essentially depends on the Angular aperture of the Objective: and that an Objective which possesses it in a high degree may be very deficient in 'definition,' and will probably have an inconveniently short working distance' with very little 'penetration'—qualities essential to an Objective to be employed in Biological investigation,—the resolution of minute Diatom tests by no means proves the fitness of an Objective for the ordinary work of the Microscopist.—Still, these tests are of great value for the purpose to which they are really adapted; and it will therefore be desirable here to specify their relative degrees of 'difficulty,' which is indicated by the closeness of their lincation, leaving for future consideration (i) the nature of the structure to which that lincation is applied. The greater part of the *Diatoms* now in use for this purpose, are comprehended in the genus *Pleurosigma* of Prof. W. Smith; which includes those *Variculae* whose 'frustules' are distinguished by their curved (or chloke) curvature (Fig. 165).

"Monthly Microscopical Journal," Vol. ix. (1873), p. 63.—A much larger number of lines to the inch has been assigned to Nobert's Test-plate by Mr. J. Allen in one of the "Proceedings of Royal Society," Vol. xxiii., 1875, p. 531, on the basis of his measurement of Photographs taken by Dr. E. Carter (Surgeon U. S. Army), but there seems strong ground to believe that either from diffraction, or from some mistake in the magnifying power employed, Mr. Broun's estimate could be greatly in excess of the reality.

		Direction of Striæ.	Striæ in 1-100th of an inch.	
			SMITH.	SOLLITT.
1.	<i>Pleurosigma formosum</i>	.... diagonal	.... 34	.... 32 — 20
2.	— strigile	.... transverse	.... 36	.... 30
3.	— <i>Balticum</i>	.... transverse	.... 38	.... 40 — 20
4.	— attenuatum	.... transverse	.... 40	.... 46 — 35
5.	— hippocampus	.... transverse	.... 40	.... 45 — 40
6.	— strigosum	.... diagonal	.... 44	.... 80 — 40
7.	— quadratum	.... diagonal	.... 45	.... 60 — 35
8.	— elongatum	.... diagonal	.... 48	
9.	— lacustre	.... transverse	.... 48	
10.	— angulatum	.... diagonal	.... 52	.... 51 — 46
11.	— æstuarii	.... diagonal	.... 54	
12.	— fasciola	.... transverse	.... 64	.... 90 — 50
13.	<i>Navicula rhomboides</i>	.... transverse	.... 85	.... 111 — 60
14.	<i>Nitzschia sigmoidea</i>	.... transverse	.... 85	
15.	<i>Amphipleura pellucida</i> . ( <i>Navicula acus</i> ).	.... transverse	....	.... 130 — 120

Good specimens of the first ten of the foregoing list may be resolved, with judicious management, by good small-angled 1-4th or 1-5th inch Objectives, and even, with very oblique illumination, by Objectives of one-half and 4-10ths inch, having an angular aperture of 90°; the remainder require the larger aperture proper to the 1-8th inch or higher power, for the satisfactory exhibition of their markings. The first column of measurements in the above table gives the numbers stated by Prof. W. Smith as *averages*; the second column gives the numbers subsequently assigned as the *extremes* by Mr. Sollitt, who pointed out that great differences exist in the fineness of the markings of specimens of the same species obtained from different localities—a statement now so abundantly confirmed, as to be entitled to rank as an established fact. It is in regard to *Amphipleura pellucida*, however, that the greatest diversity of opinion has existed; and the conclusion which the Author had expressed in the earlier editions of this Manual, that Mr. Sollitt's estimate was much too high (having been based on 'spurious' lineation), has been fully confirmed by Col. Dr. Woodward; who, having succeeded in obtaining very perfect Photographs of this Diatom, under powers of 1500 and 1650 diameters, has found that the striæ on the largest valves were never more than 91 in 1-1000th of an inch, while those on the smallest never exceeded 100 in the 1000th inch.<sup>1</sup> The 'resolution' of the *lines* on this test may be made without much difficulty by 'immersion' Objectives of 1-8th inch without any excessive Aperture; but the resolution of the lines into distinct *dots* is a severe test for Objectives of largest Aperture.—Several very difficult tests of this description have been furnished by the late Prof. Bailey<sup>2</sup> of West Point (U.S.); among them the very beautiful *Grammatophora subtilissima* and the *Hyalodiscus subtilis*, the latter being of discoid form, and having markings which radiate in all directions, very much like those of an engine-turned watch.—To these may be added the *Surirella gemma*, which presents appearances of a very deceptive character. These appearances, as represented by M. Hartnack, are shown in Fig. 118, A, B; the upper part of the valve A being illuminated by oblique light in the direction of its axis, and the lower part by oblique light in a

<sup>1</sup> 'On the Measurement of the Striæ of Diatoms,' in "Quart. Journ. of Microsc. Science," Vol. viii. (1860), p. 48.

<sup>2</sup> "Monthly Microsc. Journ.," Vol. v. (1871), p. 163.

<sup>3</sup> See his interesting Memoirs in Vols. ii. and vii. of the "Smithsonian Contributions to Knowledge." On *Hyalodiscus subtilis*, see Hendry, in "Quart. Journ. of Microsc. Science," Vol. i., N.S. (1861), p. 179.



direction transverse to its axis; while B shows a portion more highly magnified under the last illumination. This Diatom, however, has been successfully photographed by Dr. Woodward (Fig. 118, c), who says of it:—"A careful examination of specimens mounted dry, has satisfied me that Hartnack's interpretation is erroneous. The fine striæ are, I think, rows of minute hemispherical beads; the appearance of hexagons is the optical result of imperfect definition or of unsuitable illumination. For photographing this object, I have selected a frustule of somewhat less than the medium size. It measures 1/290th of an inch in length. Longitudinally the fine striæ count at the rate of 72,000 to the inch. These striæ are resolved into beaded appearances, which count laterally 84,000 to the inch."

162. As a test for those qualities of Objectives which best fit them for the general purposes of Biological investigation, the Author remains of the opinion (which he finds to be shared by many able and experienced

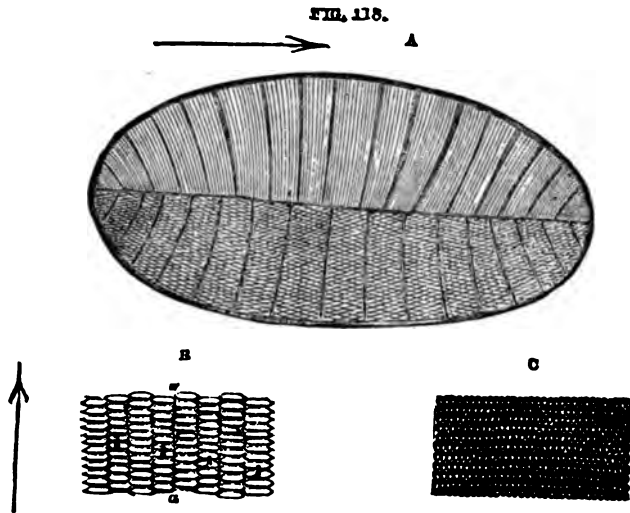

Valve of *Surirella gemma*, with portion (a) more highly magnified, showing two systems of markings *a* and *b*, as represented by Hartnack; while *c* is copied from a photograph taken by Dr. Woodward.

Microscopists, and by Makers specially familiar with their requirements) that nothing is better than the scale of the *Lepidocyrtus cervicollis*, commonly known as the *Podura* (Fig. 419). It is a fact perfectly familiar to such Makers, that an Objective may serve, in virtue of its wide Angular aperture, to resolve Diatom-tests of considerable difficulty, and may yet fail utterly on the *Podura*-scale, in consequence of its inferior defining power; and such an Objective can be of very little service to the Biological investigator. On the other hand, although the exact *structure* of the *Podura*-scale is still (like that of the Diatom-valve) a matter of discussion, yet all are agreed as to the *appearances* it presents under Objectives that combine in the fullest degree the attributes already specified as best qualifying them for Scientific work; so that any glass which shows these appearances satisfactorily, may be safely accounted suitable for that purpose. The surface of this scale, when viewed under

<sup>1</sup> "Monthly Microsc. Journ.," Vol. vi. (1871), p. 100.

a sufficiently high amplification, is seen to be covered with the peculiar markings shown in Plate II., Figs. 2, 3, which are sometimes designated 'spines,' but are more commonly known as 'notes of admiration' or 'exclamation-markings.' These should be clearly separated from each other, and their margins well defined. An Objective of *small* angle (such as a 1-4th inch of 60°) will show the 'spines' dark throughout; a 1-4th inch of 100 will show a light streak extending from the large end, down the centre of each marking; and a further enlargement of the aperture will show an extension of this streak through the entire length of each 'spine.' The degree in which these markings retain their brightness and distinctness under deep Eye-piecing, may be considered a most valuable test of the excellence of the defining power of the Objective. As it is impossible that large-angled Objectives used 'dry,' should be perfectly corrected for *spherical* aberration (so as to possess the greatest possible *defining* power) without some residuum of *chromatic* aberration, all the best defining glasses will show the thick part of the spines tinged with either blue or red. Perfect Achromatism, on the other hand, is only attainable with 'dry' lenses at some sacrifice of resolving and defining power; and many Microscopists prefer to keep the latter to their highest point, even at the expense of complete color-correction. Most Physiologists, however, will prefer the highest attainable achromatism, at some sacrifice of aperture. But it is one of the advantages of the 'immersion-system,' that the residual aberrations of even large-angled Objectives can be much more perfectly compensated than they can be in 'dry' Objectives; so that on this as on several other accounts, their use is to be recommended whenever permitted by the nature of the research.

163. *Determination of Magnifying Power.*—The last subject to be here adverted to is the mode of estimating the magnifying power of Microscopes, or, in other words, the number of times that any object is magnified. This will of course depend upon a comparison of the *real* size of the Object with the *apparent* size of the Image; but our estimate of the latter will depend upon the distance at which we assume it to be seen; since, if it be projected at different distances from the Eye, it will present very different dimensions. Opticians generally, however, have agreed to consider *ten inches* as the standard of comparison; and when, therefore, an object is said to be magnified 100 diameters, it is meant that its visual image projected at ten inches from the Eye (as when thrown down by the Camera Lucida, § 94, upon a surface at that distance beneath), has 100 times the actual dimensions of the object. The measurement of the magnifying power of Simple or Compound Microscopes by this standard is attended with no difficulty. All that is required is a Stage-Micrometer accurately divided to a small fraction of an inch (the 1-100th will answer very well for low powers, the 1-1000th for high), and a common foot-rule divided to tenths of an inch. The Micrometer being adjusted to the focus of the Objective, the rule is held parallel with it at the distance of ten inches from the eye. If the second eye be then opened whilst the other is looking through the Microscope, the circle of light included within the field of view crossed by the lines of the Micrometer will be seen faintly projected upon the rule; and it will be very easy to mark upon the latter the apparent distances of the divisions on the Micrometer, and thence to ascertain the magnifying power. Thus, supposing each of the divisions of 1-100th of an inch to correspond with  $1\frac{1}{2}$  inch upon the rule, the linear magnifying power is 150 diameters: if it correspond with half an inch, the magnifying power is 50 diameters.

If, again, each of the divisions of the 1-1000th inch Micrometer corresponds to 0.6 of an inch upon the rule, the magnifying power is 600 diameters; and if it corresponds to 1.2 inches, the magnifying power is 1200 diameters. In this mode of measurement, the estimate of *parts* of tenths on the rule can only be made by guess; but greater accuracy may be obtained by the use of the Diagonal scale (Fig. 67), or still better, by projecting the Micrometer-scale with the Camera Lucida at the distance of ten inches from the eye, marking the intervals on paper, taking an average of these, and repeating this with the compasses ten times along the inch-scale. Thus, if the space given by one of the divisions of the 1-1000th-inch Micrometer, repeated ten times along the rule, amounts to 6 inches and  $2\frac{1}{2}$  tenths, the value of each division will be .625 of an inch, and the magnifying power 625.—It is very important, whenever a high degree of accuracy is aimed at in Micrometry, to bear in mind the caution already given (§ 91) in regard to the difference in magnifying power produced in the adjustment of the Objective to the thickness of the glass that covers the object.—The *superficial* Magnifying power is of course estimated by *squaring* the linear; but this is a mode of statement never adopted by Scientific observers.

## CHAPTER V.

## PREPARATION, MOUNTING, AND COLLECTION OF OBJECTS.

164. UNDER this head it is intended to give an account of those Materials, Instruments, and Appliances of various kinds, which have been found most serviceable to Microscopists engaged in general Biological research, and to describe the most approved methods of employing them in the preparation and mounting of Objects, for the display of the minute structures thus brought to our knowledge. Not only is it of the greatest advantage that the discoveries made by Microscopic research should—as far as possible—be embodied (so to speak) in ‘preparations,’ which shall enable them to be studied by every one who may desire to do so; but it is now universally admitted that such ‘preparations’ often show so much more than can be seen in the fresh organism, that no examination of it can be considered as complete, in which the methods most suitable to each particular case have not been put in practice.—It must be obvious that in a comprehensive Treatise like the present, such a *general* treatment of this subject is all that can be attempted, excepting in a few instances of peculiar interest. And as the Histological student can find all the guidance he needs in the numerous Manuals now prepared for his instruction, the Author will not feel it requisite to furnish him with the *special* directions that are readily accessible to him elsewhere.

SECTION 1.—*Materials, Instruments, and Appliances.*

165. *Glass Slides.*—The kind of Glass best suited for mounting objects, is that which is known as ‘patent plate;’ and it is now almost invariably cut, by the common consent of Microscopists in this country, into slips measuring 3 in. by 1 inch. For objects too large to be mounted on these, the size of 3 in. by 1½ in. may be adopted. Such slips may be purchased, accurately cut to size, and ground at the edges, for so little more than the cost of the glass, that few persons to whom time is an object, would trouble themselves to prepare them; it being only when glass slides of some unusual dimensions are required, or when it is desired to construct ‘built-up cells’ (§ 174), that a facility in cutting glass with a glazier’s diamond becomes useful. The glass slides prepared for use should be free from veins, air-bubbles, or other flaws, at least in the central part on which the object is placed; and any whose defects render them unsuitable for ordinary purposes, should be selected and laid aside for uses to which the working Microscopist will find no difficulty in putting them. As the slips vary considerably in thickness, it will be advantageous to separate the *thin* and the *thick* from those of *medium* substance. The first may be employed for mounting delicate objects to be viewed



by the high powers with which the Achromatic Condenser is to be used, so as to avoid any unnecessary deflection of the illuminating pencil by the thickness of the plate which it has to traverse beneath the object; the second should be set aside for the attachment of objects which are to be ground-down, and for which, therefore, a stronger mounting than usual is desirable; and the third are to be used for mounting ordinary objects. Great care should be taken in washing the slides, and in removing from them every trace of greasiness by the use of a little soda or potass solution. If this should not suffice, they may be immersed in the solution recommended by Dr. Seiler, composed of 2 oz. of Bichromate of Potass, 3 fl. oz. of Sulphuric Acid, and 25 oz. of Water, and afterwards thoroughly rinsed. (The same solution may be advantageously used for cleansing Cover-glasses, § 132.) Before they are put away, the slides should be wiped perfectly dry, first with an ordinary 'glass-cloth,' and afterwards with an old cambric handkerchief. And before being used, each slide should be again carefully wiped, so as to remove all adherent dust. Where slides that have been already employed for mounting preparations are again brought into use, great care should be taken in completely removing all trace of adherent varnish or cement; first by scraping (care being taken not to scratch the glass), then by using an appropriate solvent, and then by rubbing the slide with a mixture of equal parts of alcohol, benzole, and liquor sodæ, finishing with clean water.

166. *Thin Glass*.—The older Microscopists were obliged to employ thin laminæ of *talc* for covering objects to be viewed with lenses of short focus: but this material, which was in many respects objectionable, is now only employed for Objectives of exceptionally short focus (such as 1-50th or 1-75th inch), being entirely superseded for other purposes by the thin glass manufactured by Messrs. Chance of Birmingham, which may be obtained of various degrees of thickness, down to 1-500th of an inch. This glass, being un-annealed, is very hard and brittle; and much care and some dexterity are required in cutting it. This should be done with the *writing* diamond; and it is advantageous to lay the thin glass upon a piece of wetted plate-glass, as its tendency to crack and 'star' is thereby diminished. For cutting *square* or other *rectangular* covers, nothing but a flat rule is required. The cutting of *rounds* by unaccustomed hands is usually attended with so much breakage, that it is really a saving of money as well as of time to purchase them from the dealers; who usually keep them in several sizes, and supply any others to order. The different thicknesses are usually ranked as 1, 2, and 3; the first being used for covering objects to be viewed with *low* powers, the second for objects to be viewed with *medium* powers; and the third for objects requiring *high* powers. The thinnest glass is of course most difficult to handle safely, and is most liable to fracture from accidents of various kinds; and hence it should only be employed for the purpose for which it is absolutely needed. The thickest pieces, again, may be most advantageously employed as covers for large Cells, in which objects are mounted in fluid (§§ 171-174) to be viewed by the low powers whose performance is not sensibly affected by the aberration thus produced. The working Microscopist will find it desirable to provide himself with some means of measuring the thickness of his cover-glass; and this is especially needed if he is in the habit of employing Objectives without adjustment, which are corrected to a particular standard (§ 17). A small screw-gauge of steel, made for measuring the thickness of rolled plates of brass, and sold at

the Tool-shops, answers this purpose very well; but Ross's *Lever of Contact* (Fig. 119), devised for this express purpose, is in many respects preferable. This consists of a small horizontal table of brass, mounted upon a stand, and having at one end an arc graduated into 20 divisions, each of which represents 1-1000th of an inch, so that the entire arc measures 1-50th of an inch; at the other end is a pivot on which moves a long and delicate lever of steel, whose extremity points to the graduated arc, whilst it has very near

(Fig. 119.)

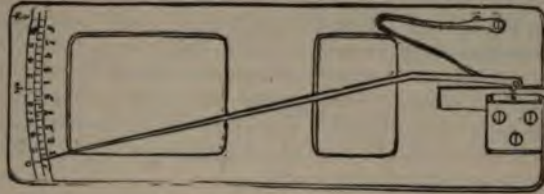

Ross's Lever of Contact.

its pivot a sort of projecting tooth, which bears at\* against a vertical plate of steel that is screwed to the horizontal table. The piece of thin-glass to be measured being inserted between the vertical plate and the projecting tooth of the lever, its thickness in thousandths of an inch is given by the number on the graduated arc to which the extremity of the lever points. Thus, if the number be 8, the thickness of the glass is .008 or 1-125th of an inch.<sup>1</sup>—It will be found convenient to sort the covers according to their thicknesses, and to keep the sortings apart, so that each may be used for the powers to which it is the most suitable. For Objectives whose angle of aperture is between 40° and 75°, glass of .008 is not too thick; for Objectives of between 75° and 120° of aperture, the thickness may range from .006 to .004; but for Objectives whose angle of aperture exceeds 120°, and whose focus is less than 1-10th of an inch, only covers of from .004 to .002 should be used.

167. On account of the extreme brittleness of the Thin-glass, it is desirable to keep the covers, when cut and sorted, in some fine and soft powder, such as Starch. Before using a cover, however, the Microscopist should be careful to clean it thoroughly; not merely for the sake of removing foulness which would interfere with the view of the object, but also for the sake of getting rid of adherent starch-grains, the presence of which might lead to wrong conclusions; and also to free the surface from that slight greasiness, which, by preventing it from being readily wetted by water, frequently occasions great inconvenience in the mounting of objects in fluid. The thicker pieces may be washed and wiped without much danger of fracture, if due care be employed; but the thinner require much precaution; and in cleansing these, a simple instrument devised by Mr. W. W. Jones will be found very useful. This consists of a small tube of brass about an inch in diameter and the same in height (a stout pill-box makes a good substitute), into which fits loosely a weighted-plug, to the flat bottom of which is cemented a piece of chamois leather. Another piece of soft leather is stretched upon a flat tablet of wood or plate-glass; and by placing the cover-glass (damped by the breath) under the plug; within the end of the tube, and keeping the tube well-down on the tablet, the glass can be rubbed between the two leather surfaces with perfect security, the weight of the plug affording sufficient pressure.<sup>1</sup>

<sup>1</sup> Another form of gauge, in which the measurement is obtained with great precision and facility by the sliding of a wedge, is described in the "Journ. of the Roy. Microsc. Soc.," Vol. ii. (1879), p. 65.

<sup>1</sup> In the improved form of this little instrument made by Messrs. Hunter &

168. *Varnishes and Cements*.—There are three very distinct purposes for which Cements that possess the power of holding firmly to Glass, and of resisting not merely water but other preservative liquids, are required by the Microscopist; these being (1) the attachment of the glass covers to the slides or cells containing the object, (2) the formation of thin ‘cells,’ of cement only, and (3) the attachment of the ‘glass-plate’ or ‘tube-cells’ to the slides. The two former of these purposes are answered by liquid cements or *varnishes*, which may be applied without heat; the last requires a *solid cement* of greater tenacity, which can only be used in the melted state.—Among the many such Cements that have been recommended by different workers, the following may be specially named as having stood the test of a large experience, both as to general utility and permanent value:—

*a. Japanners' Gold size*.—This, which may be obtained at every Color-shop, is (according to the Author's experience) the most trustworthy of all cements for closing-in mounted objects of almost any description. It takes a peculiarly firm hold of glass; and when dry it becomes extremely tough, without brittleness. When new, it is very liquid and ‘runs’ rather too freely; so that it is often advantageous to leave open for a time the bottle containing it, until the varnish is somewhat thickened. By keeping it still longer with occasional exposure to air, it is rendered much more viscid: and though such ‘old’ Gold-size is not fit for ordinary use, yet one or two coats of it may be advantageously laid over the films of newer varnish, for securing the thicker covers of large cells (§§ 171—4). Whenever any other varnish or cement is used, either in making a cell or in closing it in, the rings of these should be covered with one or two layers of Gold-size extending beyond it on either side, so as to form a continuous film extending from the marginal ring of the cover to the adjacent portion of the glass slide.<sup>1</sup>

*b. Asphalte Varnish*.—This is a black varnish made by dissolving half a drachm Caoutchouc in mineral naphtha, and then adding 4 oz. of Asphaltum, using heat if necessary for its solution. It is very important that the Asphaltum should be genuine, and the other materials of the best quality. Some use Asphalte as a substitute for gold-size; but the Author's experience leads him to recommend that it should only be employed either for making shallow ‘cement-cells’ (§§ 170), or for finishing-off preparations already secured with gold-size. For the former purpose it may advantageously be slightly thickened by evaporation.

*c. Black Japan*.—The varnish sold at the Color-shops under this name, may be used for the same purposes as the preceding. When it is used for making ‘cement-cells,’ the slides to which it has been applied should be exposed for a time to the heat of an oven, not raised so high as to cause it to blister; this will increase its adhesion to the glass slide, and will flatten the surface of the rings.

*d. Dammar Cement*, which is made by dissolving gum dammar in benzole, and adding about one-third of gold-size, has the advantage of drying very quickly; and may be preferably used for a first coat when glycerine is used as the material for mounting.

*e. Bell's Cement* may be recommended on the same grounds; but it ‘runs’ so freely, that for ordinary purposes the Author much prefers gold-size or dammar.

*f. Canada Balsam* is so brittle when hardened by time, that it cannot be safely used as a cement, except for the special purpose of attaching hard specimens to glass, in order that they may be reduced by grinding, etc. Although fresh soft balsam may be hardened by heating it on the slide to which the object is to be attached, yet it may be preferably hardened *en masse* by exposing it in a shallow vessel to the prolonged but moderate heat of an oven, until so much of its volatile oil has been driven off that it becomes *almost* (but not quite) resinous on cooling. If, when a drop is spread out on a glass and allowed to become quite cold, it is found to be so hard as not to be readily indented by the thumb-nail, and

---

Sands, the leather is not cemented to the bottom of the plug, but merely strained over it, so as to be easily renewable.

<sup>1</sup>The Author has fluid preparations mounted with Gold-size nearly forty years ago, which have remained perfectly free from leakage; the precaution having been taken to lay on a fresh coat every two or three years.

yet not so hard as to 'chip,' it is in the best condition to be used for cementing. If too soft, it will require a little more hardening on the slide, to which it should be transferred in the liquid state, being brought to it by the heat of a water-bath; if too hard, it may be dissolved in chloroform or benzole, for use as a mounting 'medium' (§ 205).

*g. Shell-lac Cement* is made by keeping small pieces of picked Shell-lac in a bottle of rectified spirit, and shaking it from time to time. It cannot be recommended as a substitute for any of the preceding; as, when dry and hard, it has little hold on glass. But it answers very well for making cells for dry-mounting (§ 167).—What is known as *Liquid-glue* is an inferior kind of the same cement, made by dissolving inferior shell-lac or some commoner resin, in naphtha. It cannot be trusted for a permanent hold; and those who employ it are likely to find themselves disappointed in regard to the *durability* of their preparations.<sup>1</sup>

*h. Marine Glue*, which is composed of Shell-lac, caoutchouc, and naphtha, is distinguished by its extraordinary tenacity, and by its power of resisting solvents of almost every kind. Different qualities of this substance are made for the several purposes to which it is applied; and the one most suitable to the wants of the Microscopist is known in commerce as G K 4. The special value of this cement, which can only be applied hot, is in attaching to glass slides the glass or metal rings which thus form 'cells' for the reception of objects to be mounted in fluid; no other cement being comparable to it either for tenacity or for durability. The manner of so using it will be presently described (§ 171).

*i. Various colored Varnishes* are used to give a finish to mounted preparations, or to mark on the covering-glasses of large preparations the parts containing special kinds of noteworthy structure. A very good *black* varnish of this kind is made by working up very finely powdered lamp-black with gold-size. For *red*, *sealing-wax* varnish made by dissolving red sealing-wax (the best is alone worth using) in rectified spirit, is commonly used; but it is very liable to chip and leave the glass, when hardened by time. The red varnish specially prepared for Microscopic purposes by Messrs. Thompson & Capper (of Liverpool) seems likely to stand better, but the Author's experience of it has been short. For white, 'zinc cement' answers well: which may be made by dissolving 1 oz. of gum dammar in 1 oz. of oil of turpentine by the aid of heat; rubbing up 1 drachm of oxide of zinc with an equal quantity of oil of turpentine (adding the latter by drop) into a creamy mixture perfectly free from lumps or grit; and then mixing the two fluids, which must be well stirred together, and strained through a piece of fine muslin previously wetted with turpentine. Blue or green pigments may be worked-up with this, if cements of those colors be desired.

*k. For attaching labels and covering papers to slides either of glass or wood, and for fixing-down small-objects to be mounted 'dry' (such as Foraminifera, parts of Insects, etc.), the Author has found nothing preferable to a rather thick mucilage of Gum Arabic, to which enough Glycerine has been added to prevent it from drying hard, with a few drops of some Essential oil to prevent the development of mould. The following formula has also been recommended:—Dissolve 2 oz. of Gum Arabic in 2 oz. of water, and then add 1-4th oz. of soaked gelatine (for the solution of which the action of heat will be required), 80 drops of glycerine, and a lump of camphor.—The further advantage is gained by the addition of a slightly increased proportion of Glycerine to either of the foregoing, that the gum can be very readily softened by water; so that covers may be easily removed (to be cleansed if necessary) and the arrangement of objects (where many are mounted together, § 175) altered.*

169. *Cells for Dry-mounting.*—Where the object to be mounted 'dry' (*i.e.* not immersed either in fluid or in any 'medium') is so thin as to require that the cover should be but little raised above the slide a 'cement cell' (§ 170) answers this purpose very well; and if the application of a gentle warmth be not injurious, the pressing-down of the cover on the softened cement will help both to fix it, and to prevent the varnish applied round its border from running in. Where a somewhat deeper cell is

<sup>1</sup> From the appearance and smell of the Hollis's Glue recommended by Dr. Heneage Gibbs, the Author cannot but believe that its nature is essentially the same as that of ordinary 'liquid glue,' and that it is therefore liable to the same objection.



required, it can be made in the manner suggested by Prof. H. L. Smith (U.S.) specially for the mounting of Diatoms. A sheet of thin writing-paper dipped into thick shell-lac varnish is hung up to dry; and rings are then cut out from it by punches of two different sizes. One of these rings being laid on a glass slide, and the cover, with the object dried upon it, laid on the ring, it is to be held in its place by the forceps or spring-clip, and the slide gently warmed so as cause a slight adhesion of the cover to the ring, and of the ring to the slide; and this adhesion may then be rendered complete, by laying another glass slide on the cover, and pressing the two slides together, with the aid of a continued gentle heat.—Still deeper cells may be made with rings punched out of tin-foil of various thicknesses; and cemented with shell-lac varnish on either side. And if yet deeper cells are needed, they may be made of turned rings of vulcanite or ebonite, cemented in the same manner.—It is always safer to protect such dry mounts by attaching paper covers to the slides; as the tendency of the rings to start at any 'jar,' when the shell-lac has re-acquired its resinous hardness, is thereby greatly diminished.—Small objects, such as *Diatoms* and *Polycystina*, which are to be viewed by Lieberkühn illumination (§ 115), should be mounted on disks punched out of thin black card-board, whose diameter scarcely exceeds the field of the Objective under which they are to be shown; and the protecting cell should be large enough to allow an ample opening for the light-rays to pass up from the mirror to the speculum, between the inner edge of its ring and the outer margin of the disk.

170. *Cement-Cells*.—Cells for mounting *thin* objects in any watery medium, may be readily made with Asphalte or Black Japan varnish, by the use of Mr. Shadbolt's 'Turn-table' (§ 176) or one of its modifications.

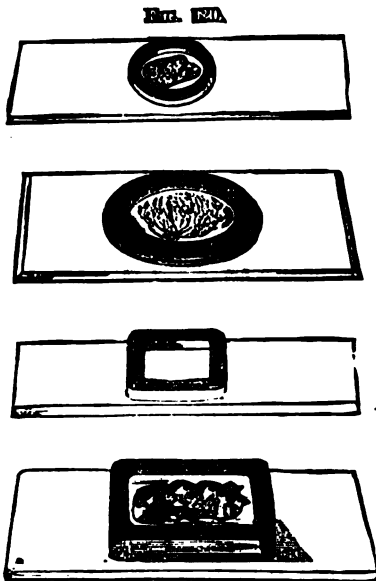

Tube-Cells, Round and Quadrangular.

The glass slide being placed under its springs, in such a manner that its two edges shall be equidistant from the centre (a guide to which position is afforded by the circles traced on the brass), and its four corners equally projecting beyond the circular margin of the plate, a camel's hair pencil dipped in the varnish is held in the right hand, so that its point comes into contact with the glass over whichever of the circles may be selected as the guide to the size of the ring. The turntable being made to rotate by the application of the left fore-finger to the milled-head beneath, a ring of varnish of a suitable breadth is made upon the glass; and if this be set aside in a horizontal position, it will be found, when hard, to present a very level surface. If a greater thickness be desired than a single application will conveniently make, a second layer may be afterwards laid on. It will be found convenient to make a considerable number of such cells at once, and to keep a stock of them ready prepared

for use. If the surface of any ring should not be sufficiently level for a covering-glass to lie flat upon it, a slight rubbing upon a piece of fine emery-paper laid upon a flat table (the ring being held downwards) will make it so.

171. *Ring-cells*.—For mounting objects of greater thickness, it is desirable to use cells made by cementing rings, either of glass or metal, to the glass slides, with marine glue. Glass-rings of any size, diameter, thickness, and breadth are made by cutting transverse sections of thick walled tubes; the surfaces of these sections being ground flat and parallel. Not only may round cells (Fig. 120 A, B) of various sizes be made by this simple method, but, by flattening the tube (when hot) from which they are cut, the sections may be made quadrangular or square, or oblong (C, D). For intermediate thicknesses between cement-cells and glass ring-cells, the Author has found no kind so convenient as the rings (sold by Mr. Collins) stamped out of tin, of various thicknesses. These, after being cemented to the slides, should have their surfaces made perfectly flat by rubbing on a piece of fine grit or a corundum-file, and then smoothed on a Water of Ayr stone; to such surfaces the glass covers will be found to adhere with great tenacity.

The Glass Slides and Cells which are to be attached to each other, must first be heated on the Mounting plate; and some small cuttings of Marine glue are then to be placed either upon that surface of the cell which is to be attached, or upon that portion of the slide on which it is to lie, the former being perhaps preferable. When they begin to melt, they may be worked over the surface of attachment by means of a needle point; and in this manner the melted glue may be uniformly spread, care being taken to pick out any of the small gritty particles which this cement sometimes contains. When the surface of attachment is thus completely covered with liquefied glue, the cell is to be taken up with a pair of forceps, turned over, and deposited in its proper place on the slide; and it is then to be firmly pressed down with a stick (such as the handle of the needle), or with a piece of flat wood, so as to squeeze out any superfluous glue from beneath. If any air-bubbles should be seen between the cell and the slide, these should if possible be got rid of by pressure, or by slightly moving the cell from side to side; but if their presence results, as is sometimes the case, from deficiency of cement at that point, the cell must be lifted off again, and more glue applied at the required spot. Sometimes, in spite of care, the glue becomes hardened and blackened by overheating; and as it will not then stick well to the glass, it is preferable not to attempt to proceed, but to lift off the cell from the slide, to let it cool, scrape off the overheated glue, and then repeat the process. When the cementing has been satisfactorily accomplished, the slides should be allowed to cool gradually in order to secure the firm adhesion of the glue; and this is readily accomplished, in the first instance, by pushing each, as it is finished, towards one of the extremities of the plate. If two plates are in use, the heated plate may then be readily moved away upon the ring which supports it, the other being brought down in its place, and as the heated plate will be some little time in cooling, the firm attachment of the cells will be secured. If, on the other hand, there be only a single plate, and the operator desire to proceed at once in mounting more cells, the slides already completed should be carefully removed from it, and laid upon a *wooden* surface, the slow conduction of which will prevent them from cooling too fast. Before they are quite cold, the superfluous glue should be scraped from the glass with a small chisel or awl; and the surface should then be carefully cleansed with a solution of potash, which may be rubbed upon it with a piece of rag covering a stick shaped like a chisel. The cells should next be washed with a hard brush and soap and water, and may be finally cleansed by rubbing with a little weak spirit and a soft cloth. In cases in which *appearance* is not of much consequence, and especially in those in which the cell is to be used for mounting large opaque objects, it is decidedly preferable not to scrape off the glue too closely round the edges of attachment; as the 'hold' is much firmer, and the probability of the penetration of air or fluid much less, if the immediate margin of glue be left both outside and inside the cell.—To those to whom *time* is of value, it is recommended that all cells which require Marine-glue cementing be purchased from the dealers in Microscopic apparatus.

172. *Plate-Glass Cells*.—Where large shallow cells with flat bottoms are required (as for mounting *Zoophytes*, small *Medusæ*, etc.), they may be made by drilling holes in pieces of plate glass of various sizes, shapes, and thicknesses (Fig. 121, A), which are then cemented to glass slides with marine glue. By drilling two holes at a suitable distance and cutting out the piece between them, any required elongation of the cavity may be obtained (B, C, D).

FIG. 121.

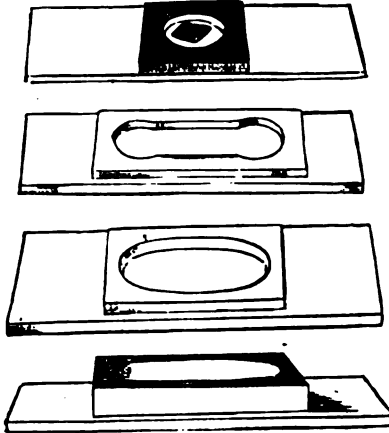
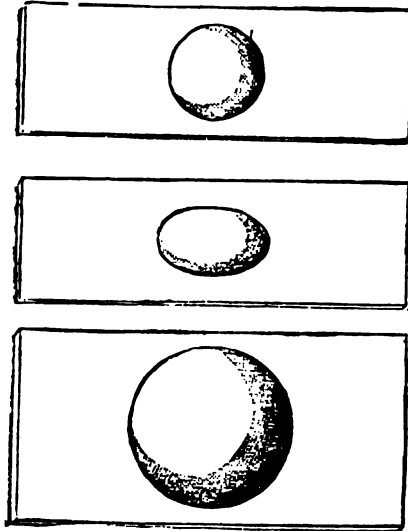

Plate-Glass Cells.

FIG. 122.



Sunk Cells.

173. *Sunk Cells*.—This name is given to round or oval hollows excavated in the substance of glass slides, which, for this purpose, should be thicker than ordinary. Such cells have the advantage not only of comparative cheapness, but also of durability, as they are not liable to injury by a sudden jar, such as sometimes causes the detachment of a cemented plate or ring. For objects whose shape adapts them to the form and depth of the cavity, such cells will be found very convenient; thus the Author has a series of young *Comatulæ* (Fig. 378) thus mounted, which are extremely well displayed, alike on their upper and on their under surfaces. It naturally suggests itself as an objection to the use of such cells, that the concavity of their bottom must so deflect the light rays, as to distort or obscure the image; but as the cavity is filled either with water or some other liquid of higher refractive power; the deflection is so slight as to be practically inoperative. Before mounting objects in such cells, the Microscopist should see that their concave surfaces are free from scratches or roughness.

174. *Built-up Cells*.—When cells are required of forms or dimensions not otherwise procurable, they may be *built up* of separate pieces of glass cemented together. Large *shallow Cells*, suitable for mounting *Zoophytes* or similar flat objects, may be easily constructed after the

following method:—A piece of plate-glass, of a thickness that shall give the desired depth to the cell, is to be cut to the dimensions of its outside

wall; and a strip is then to be cut off with the diamond from each of its edges, of such breadth as shall leave the interior piece equal its dimensions to the cavity of the cell that is desired. This piece being rejected, the four strips are then to be cemented upon the glass slide in their original position, so that the diamond-cuts shall fit together with the most exact precision; and the upper surface is then to be ground flat with emery upon a pewter plate, and left rough.—The perfect construction of large *deep* cells of this kind (Fig. 123, A, B), however, requires a nicety of workmanship which few amateurs possess, and the expenditure of more time than Microscopists generally have to spare; and as it is consequently preferable to obtain them ready-made, directions for making them need not be here given.

175. *Wooden Slides for Opaque Objects*.—Such 'dry' objects as *Foraminifera*, the capsules of *Mosses*, parts of *Insects*, and the like, may be conveniently mounted in a very simple form of wooden

slide (first devised by the Author and now come into general use), which also serves as a protective 'cell.' Let a number of slips of mahogany or cedar be provided, each of the 3-inch by 1-inch size, and of any thickness that may be found convenient, with a corresponding number of slips of card of the same dimensions, and of pieces of *dead*-black paper rather larger than the aperture of the slide. A piece of this paper being gummed to the middle of the card, and some stiff gum having been previously spread over one side of the wooden slide (care being taken that there is no superfluity of it immediately around the aperture), this is to be laid down upon the card, and subjected to pressure.<sup>1</sup> An extremely neat 'cell' will thus be formed for the reception of the object (Fig. 124), the depth of which will be determined by the thickness of the slide, and the diameter by the size of the perforation; and it will be found convenient to provide slides of various thicknesses, with apertures of different sizes. The cell should always be deep enough for its wall to rise above the object; but, on the other hand, it should not be too deep for its walls to interfere with the oblique incidence of the light upon any object that may be near its periphery. The object, if flat or small, may be attached by Gum-mucilage (§ 168 *k*); if, however, it be large, and the part of it to be attached have an irregular surface, it is desirable to form a 'bed' to this by gum thickened with starch. If, on the other hand, it should be desired to mount the object edgewise (as when the *mouth* of a *Foraminifer* is to be brought into view), the *side* of the object may be attached with a little gum to the *wall* of the cell.—The complete protection thus given to the Object is the great recommendation of this method. But this is by no

FIG. 123.

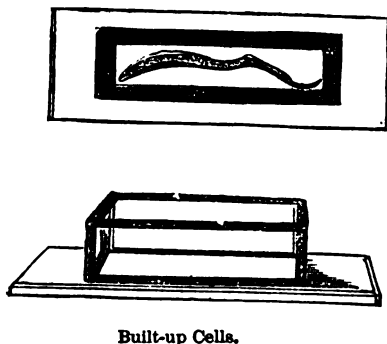

<sup>1</sup> It will be found a very convenient plan to prepare a large number of such Slides at once: and this may be done in a marvellously short time, if the slips of card have been previously cut to the exact size in a bookbinder's press. The slides, when put together, should be placed in pairs, back to back; and every pair should have each of its ends embraced by a Spring-press (Fig. 129) until dry.



means its only convenience. It allows the slides not only to range in the ordinary Cabinets, but also to be laid one against or over another, and to be packed closely in cases, or secured by elastic bands; which plan is extremely convenient not merely for the saving of space, but also for preserving the objects from dust. Should any more special protection be required, a thin glass cover may be laid over the top of the cell, and secured there either by a rim of gum or by a perforated paper cover attached to the slide; and if it should be desired to pack these covered slides together, it is only necessary to interpose *guards* of card somewhat thicker than the glass covers.

176. *Turn-table*.—This simple instrument (Fig. 125), devised by Mr.



Wooden Slide for Opaque Objects.

Shadbolt's Turn-table for making Cement-Cells.

Shadbolt, is almost indispensable to the Microscopist who desires to preserve preparations that are mounted in any 'medium' beneath circular covers; since it not only serves for the making of those 'Cement-cells' (§ 170) in which thin transparent objects can be best mounted in any kind of 'medium' but also enables him to apply his varnish for the securing of circular cover-glasses not only with greater neatness and quickness, but also with greater certainty than he can by the hand alone. As the method of using it for the latter purpose is essentially the same as that

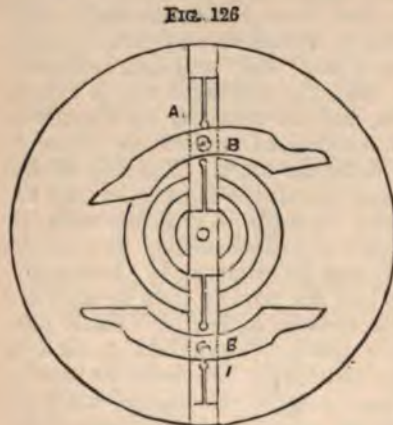

Dunning's turn-table.

already described under the former head, it need not be here repeated; the only special precaution to be observed, being that the cover-glass, not the slide, should be 'centered;' which can be readily done, if *several* concentric circles have been turned on the rotating-table, by making the cover-glass correspond with the one having its own diameter.—A number of ingenious modifications have been devised in this simple instrument, with the view of securing exact centering; the simplest of them (which has the advantage of being applicable at a trifling expense to any existing turn-table) being that of Mr. C. S. Rolfe.<sup>1</sup> But as it is often requisite to use this instrument with slides not accurately cut to size and

shape, or of greater breadth than the 'regulation' 1-inch, the Author is disposed to prefer the form devised by Mr. Dunning<sup>2</sup> (Fig. 126). The circular

<sup>1</sup> "Journal of the Quekett Microscopical Club," Vol. v., p. 249.

<sup>2</sup> *Op. cit*, vol. vi., p. 81.

table, made rather thicker than usual, has a dovetail groove ploughed out across its diameter, in which work two sliding guides A, A, the ends of which are cut and 'sprung,' so as to have a sufficiently firm hold. These guides carry the two clips B, B; one of which is fixed at right angles to its guide, whilst the other is pivoted, in order that it may adjust itself to any irregularity in the form of the slide.—When Cement-cells are being made either with this or the ordinary Turn-table, it is convenient to mark the centre of each slide with a dot of ink on its under surface; this may be easily applied in its right place by laying on it a slip of card cut to the regulation size, with a small central perforation; and by so laying down the slide that the dot lies on the centre of the rotating plate, much trouble may afterwards be saved.

177. *Mounting Plate and Water-bath.*—Whenever heat has to be applied either in the cementing of Cells or in the mounting of Objects, it is desirable that the slide should not be exposed direct to the flame, but that it should be laid upon a surface of regulated temperature. As cementing with Marine Glue or hardened Canada Balsam requires a heat above that of boiling water, it must be supplied by a plate of metal; and the Author's experience leads him to recommend that this should be a piece of iron not less than six inches square and half an inch thick; and that it should be supported, not on legs of its own, but on the ring of a Retort-stand, so that by raising or lowering the ring, any desired amount of heat may be imparted to it by the lamp or gas-flame beneath. The advantage of a plate of this size and thickness consists in the *gradational* temperature which its different parts afford, and in the slowness of its

FIG. 127.



Slider-Forceps.

cooling when removed from the lamp. When many cells are being cemented at once, it is convenient to have two such plates, that one may be cooling while the other is being heated.—The Retort-stand also serves for the support of the Water-bath, which affords the heat required for liquefying and mixing the fats employed in the imbedding process (§ 189), for melting the glycerine jelly or other media used in mounting, and for a variety of other purposes. A circular-bottomed flat tin vessel, 6 inches in diameter and  $2\frac{1}{2}$  inches deep, with a handle like that of a saucepan, and two covers,—one a flat plate of 8 inches square (its edges guarded by being turned over wire) for slides to lie upon, having a hole large enough to admit a small bottle of cement or medium,—the other fitting the vessel, but with an opening large enough for a porcelain basin,—will answer every purpose.

178. *Slider-Forceps, Spring Clip, and Spring-Press.*—For holding slides to which heat is being applied, especially while cementing objects to be ground-down into thin sections, the wooden *Slider-Forceps* (Fig. 127) will be found extremely convenient. This, by its elasticity, affords a secure grasp to a slide of any ordinary thickness, the wooden blades being separated by pressure upon the brass studs; while the lower stud, with the bent piece of brass at the junction of the blades, affords a level support to the forceps, which thus, while resting upon the table, keeps



the heated glass from contact with its surface. For holding-down cover-glasses whilst the balsam or other medium is cooling, if the elasticity of the object should tend to make them spring-up, the wire Spring-Clip (Fig. 128), sold at a cheap rate by dealers in Microscopic apparatus, will be found extremely convenient. Or, if a stronger pressure be required, recourse may be had to a simple Spring-Press made by a light alteration of the 'American clothes peg' which is now in general use in this country for a variety of purposes; all that is necessary being to rub down the opposed surfaces of the 'clip' with a flat file, so that they shall be parallel to each other when an ordinary slide with its cover is interposed between them (Fig. 129). One of these convenient little implements may also be

FIG. 128.

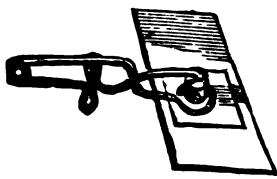

Spring-Clip.

FIG. 129.



Spring-Press.

easily made to serve the purpose of a Slider-forceps, by cutting back the upper edge of the clip, and filing the lower to such a plane that when it rests on its flat side, it shall hold the slide parallel to the surface of the table, as in Fig. 127.

179. *Mounting Instrument*.—A simple mode of applying graduated pressure concurrently with the heat of a lamp, which will be found very convenient in the mounting of certain classes of objects, is afforded by the Mounting instrument devised by Mr. James Smith. This consists of a plate of brass turned up at its edges, of the proper size to allow the ordinary glass slide to lie loosely in the bed thus formed, this plate has a large perforation in its centre, in order to allow heat to be directly applied to the slide from beneath, and it is attached by a stout wire to a handle (Fig. 130). Close to this handle there is attached by a joint an upper

FIG. 130.



Smith Mounting Instrument.

wire, which lies nearly parallel to the first, but makes a downward turn just above the centre of the slide-plate, and is terminated by an ivory knob; this wire is pressed upwards by a spring beneath it, whilst, on the other hand, it is made to approximate the lower by a milled-head turning on a screw, so as to bring its ivory knob to bear with greater or less force on the covering glass. The special use of this arrangement will be explained hereafter (§ 210).

180. *Dissecting Apparatus*.—The mode of making a dissection for Microscopic purposes must be determined by the size and character of the object. Generally speaking, it will be found advantageous to carry on

the dissection under Water, with which Alcohol should be mingled where the substance has been long immersed in spirit. The size and depth of the vessel should be proportioned to the dimensions of the object to be dissected; since, for the ready access of the hands and dissecting-instruments, it is convenient that the object should neither be far from its walls, nor lie under any great depth of water. Where there is no occasion that the bottom of the vessel should be transparent, no kind of Dissecting trough is more convenient than that which every one may readily make for himself, of any dimension he may desire, by taking a piece of sheet Gutta-percha of adequate size and stoutness, warming it sufficiently to render it flexible, and then turning-up its four sides, drawing out one corner into a sort of spout, which serves to pour away its contents when it needs emptying. The dark color of this substance enables it to furnish a back-ground, which assists the observer in distinguishing delicate membranes, fibres, etc., especially when magnifying lenses are employed; and it is hard enough (without being too hard) to allow of pins being fixed into it, both for securing the object, and for keeping apart such portions as it is useful to put on the stretch. When glass or earthenware troughs are employed, a piece of sheet-cork loaded with lead must be provided, to answer the same purposes. In carrying-on dissections in such a trough, it is frequently desirable to concentrate additional light upon the part which is being operated-on, by means of the smaller Condensing-lens (Fig. 86); and when a low magnifying power is wanted, it may be supplied either by a single lens mounted after the manner of Ross's Simple Microscope (Fig. 31, B), or by a pair of Spectacles mounted with the 'semi-lenses,' ordinarily used for Stereoscopes.<sup>1</sup> Portions of the body under dissection being floated-off when detached, may be conveniently taken up from the trough by placing a slip of glass beneath them (which is often the only mode in which delicate membranes can be satisfactorily spread out); and may be then placed under the Microscope for minute examination, being first covered with thin glass, beneath the edges of which is to be introduced a little of the liquid wherein the dissection is being carried-on. Where the body under dissection is so transparent, that more advantage is gained by transmitting light through it than by looking at it as an opaque object, the trough should have a glass bottom, and for this purpose, unless the body be of unusual size, some of the Glass Cells already described (Figs. 121-123) will usually answer very well. The finest dissections may often be best made upon ordinary slips of glass; care being taken to keep the object sufficiently surrounded by fluid. For work of this kind no simple instrument is more generally serviceable than the Laboratory Dissecting Microscope (Fig. 35), which will carry any power from 3-inch to a 1-4th inch; whilst the Stephenson Erecting Binocular (Fig. 47) may be used with the like supports for the hands, when a higher power is preferred.

181. The *Instruments* used in Microscopic dissection are for the most part of the same kind as those which are needed in ordinary minute Anatomical research, such as scalpels, scissors, forceps, etc.; the fine instru-

---

<sup>1</sup> The author can strongly recommend these Spectacles, as useful in a great variety of manipulations which are best performed under a low magnifying power, with the conjoint use of both eyes.—Where a higher power is needed, recourse may be advantageously had to Messrs. Beck's 8-inch Achromatic Binocular Magnifier, which is constructed on the same principle, allowing the object to be brought very near the eyes, without requiring any uncomfortable convergence of their axes.



ments used in operations upon the eye, however, will commonly be found most suitable. A pair of delicate scissors, curved to one side, is extremely convenient for cutting open tubular parts; these should have their points blunted; but other scissors should have fine points. A pair of very fine-pointed Scissors (Fig. 131), one leg of which is fixed in a light handle, and the other kept apart from it by a spring, so as to close by the pressure of the finger and to open of itself, will be found (if the blades be well sharpened) much superior to any kind of knives, for cutting through delicate tissues with as little disturbance of them as possible.—A pair of small straight Forceps with fine points, and another pair of curved forceps will be found useful in addition to the ordinary dissecting forceps.

182. Of all the instruments contrived for delicate dissections, however, none are more serviceable than those which the Microscopist may make for himself out of ordinary *needles*. These should be fixed in light

FIG. 131.

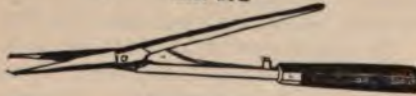

Spring-Scissors.

FIG. 132.



Curved Scissors for Cutting thin Sections.

wooden handles<sup>1</sup> (the cedar sticks used for camel-hair pencils, or the handles of steel-penholders, or small Porcupine-quills, will answer extremely well), in such a manner that their points should not project far,<sup>2</sup> since they will otherwise have too much 'spring;' much may be done by their mere *tearing* action; but if it be desired to use them as *cutting* instruments, all that is necessary is to harden and temper them, and then give them an edge upon a hone. It will sometimes be desirable to give a finer point to such needles than they originally possess; this also may be done upon a hone. A needle with its point bent to a right angle, or nearly so, is often useful; and this may be shaped by simply heating the point in a lamp or candle, giving to it the required turn with a pair of pliers, and then hardening the point again by reheating it and plunging it into cold water or tallow.

183. *Section-cutting*.—The young Microscopist will do well to practise the cutting of thin Sections of soft Vegetable and animal substances with a sharp razor: considerable practice is needed, however, to make effectual use of it; and some individuals acquire a degree of dexterity which

<sup>1</sup> The handles of ladies Crochet-needles have been recommended for this purpose; and although they afford the facility of lengthening or shortening the acting point of the needle at will, and also of carrying a reserve store of needles at the other end, yet the Author would decidedly recommend the use of the wooden handles, of which it will be found convenient always to have several at hand, mounted with needles of different sizes.

<sup>2</sup> The following is the mode in which the Author has found it convenient to mount his needles for this and other purposes:—The needle being held firmly in a pair of pliers grasped by the right hand, its point may be forced into the end of a cedar or other stick held in the left, until it has entered to the depth of half an inch or more; the needle is then cut off to the desired length (the eye-end being thus got rid of); and being then drawn out of the stick, the truncated end is forced into the hole previously made by the point, until it cannot be made to penetrate farther, when it will be found to be very securely fixed. The end of the handle which embraces it may then be bevelled-away round its point of insertion.



others never succeed in attaining. The making of hand-sections will be greatly facilitated by the previous use of the hardening and imbedding processes to be hereafter described (§§ 189, 199); but the best of them rarely equal good sections cut by a Microtome.—For the preliminary examination of any soft structure, such a pair of Scissors as is represented in Fig. 132 will often be found very useful; since, owing to the curvature of the blades, the two extremities of a section taken from a flat surface will generally be found to thin away, although the middle of it may be too thick to exhibit any structure. The two-bladed Knife contrived by Prof. Valentin was formerly much used for cutting microscopic sections of soft tissues: but as such sections can be cut far more effectively by the methods to be presently described, a mere mention of this instrument will here suffice.

184. *Microtome*.—There is a large class of substances, of moderate hardness, both Animal and Vegetable, of which extremely thin and uniform slices can be made by a sharp-cutting instrument, if they be properly held and supported, and the thickness of the section be regulated by a mechanical contrivance; such are, in particular, the Stems and Roots of Plants, and the Horns, Hoofs, Cartilages, and similarly firm structures of Animals. Various costly machines have been devised for this purpose, some of them characterized by great ingenuity of contrivance and beauty of workmanship, but most of the purposes to which these are adapted will be found to be answered by a very simple and inexpensive little instrument, which may either be held in the hand, or (as is preferable) may be firmly attached by means of a T-shaped piece of wood (Fig. 133), to the end of a table or work-bench. This instrument essentially consists of an upright hollow cylinder of brass, with a kind of piston which is pushed from below upwards by a fine-threaded or 'micro-meter' screw turned by a large milled-head, at the upper end the cylinder terminates in a brass table, which is planed to a flat surface, or (which is preferable) has a piece of plate-glass cemented to it, to form its cutting bed. At one side is seen a small milled-head, which acts upon a 'binding screw,' whose extremity projects into the cavity of the cylinder, and serves to compress and steady anything that it holds. For this is now generally substituted a pair of screws, working through the side of the cylinder, as in Fig. 120. A cylindrical stem of wood, a piece of horn, whalebone, cartilage, etc., is to be fitted to the interior of the cylinder so as to project a little above its top, and is to be steadied by the 'binding screw;' it is then to be cut to a level by means of a sharp knife or razor laid flat upon the table. The large milled-head is next to be moved through such a portion of a turn as may very slightly

FIG. 133.

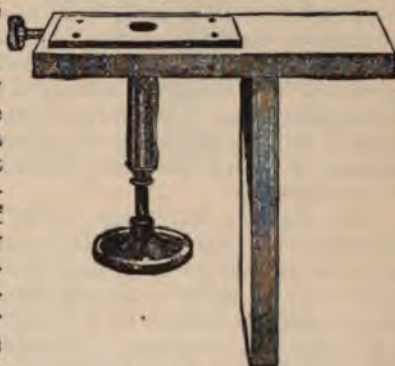

Simple Microtome.

<sup>1</sup> It is difficult to convey by a drawing the idea of the real curvature of this instrument, the blades of which, when it is held in front view, curve—not to either side—but towards the observer; these scissors being, as the French instrument-makers say, *courbés sur le plat*.



elevate the substance to be cut, so as to make it project in an almost insensible degree above the table, and this projecting part is to be sliced off with a knife previously dipped in water. For many purposes an ordinary razor will answer sufficiently well; but thinner and more uniform sections can be cut by a special knife having its edge parallel to its back, its sides slightly concave, and its back with a uniform thickness of rather less than 1-4th inch. Such a knife should be 4 or 5 inches long, and 7-8ths inch broad; and should be set in a box-wood handle about 4 inches long (Dr. S. Marsh). The motion given to its edge should be a combination of *drawing* and *pressing*. (It will be generally found that better sections are made by working the knife *from* the operator, than *towards* him). When one slice has been thus taken off, it should be removed from the blade by dipping it into water, or by the use of a camel-hair brush; the milled-head should be again advanced, and another section taken: and so on. Different substances will be found both to *bear* and to *require* different degrees of thickness; and the amount that suits each can only be found by trial. It is advantageous to have the large milled-head graduated, and furnished with a fixed index; so that this amount having been once determined, the screw shall be so turned as to always produce the exact elevation required.—Where the substance of which it is desired to obtain sections by this instrument is of too small a size or of too soft a texture to be held firmly in the manner just described, it may be placed between the two vertical halves of a cork of suitable size to be pressed into the cylinder; and the cork, with the object it grasps, is then to be sliced in the manner already described, the small section of the latter being carefully taken-off the knife, or floated-away from it, on each occasion, to prevent it from being lost among the lamellæ of cork which are removed at the same time. Vertical sections of many Leaves may be successfully made in this way; and if their texture be so soft as to be injured by the pressure of a cork, they may be placed between two half-cylinders of carrot or elder-pith.

185. *Hailes's Microtome*.—The foregoing simple form of Microtome has received, at various hands, numerous modifications of detail, without any essential change in its plan of construction. Its chief defect is, that as the body to be cut is directly acted-on by the screw at the bottom of the cylinder, its motion (if it be tightly held by the binding screws) is apt to be jerky and irregular. To remedy this defect, Mr. H. P. Hailes has devised an improved model, the essential feature of which is that the body to be cut is secured within an inner tube, which, sliding freely within the outer cylinder, is raised smoothly and equally by the micrometer screw attached to the base of the latter, as shown in Fig. 134 (1, 2). The cutting-bed formed by the flange B, is provided with two slips *b* of hardened steel, on which, in ordinary section-cutting, the knife or razor slides horizontally, as in the ordinary Microtome. But by the addition shown in 3, 4, this instrument can also be effectively adapted for cutting thin sections of substances hard enough to require the use of the saw. At the back of the cutting-bed, there can be secured (by means of the screw and and steadying-pins) a metal block, *b'*, which carries two guides *b<sup>1</sup>*, *b<sup>2</sup>*, of hard steel; and these, when thus attached, lie over the two similar strips fixed on the cutting-bed. By passing the blade of a fine saw between the movable guides and the fixed strips, and screwing down the former (which are raised by a spring) as far as will confine the saw without impeding its working, sections of Bone, Teeth, etc., may be cut as thin as the nature of the substance will allow, and with a uniformity that with-

out such guidance cannot be attained.—When the Microtome is employed for this last purpose, the saw may be most conveniently worked vertically; and this is readily done by detaching the instrument from the table, and holding it down upon its clamp-side, which is so shaped as to afford a level support.

186. In what is known as the *Strasburg Microtome*, invented by Prof. Schiefferdecker, the substance to be cut is *fixed* in the cylinder by binding-screws, while the circular cutting-bed, instead of being fixed on the upper end of the cylinder, is made to *screw* upon it, so as to be raised or lowered by turning it round. Thus, after a section has been taken, a slight lowering of the cutting-bed, measured by the graduation of its margin, prepares it for the cutting of the next.<sup>1</sup>—The simplicity of this

FIG. 182.

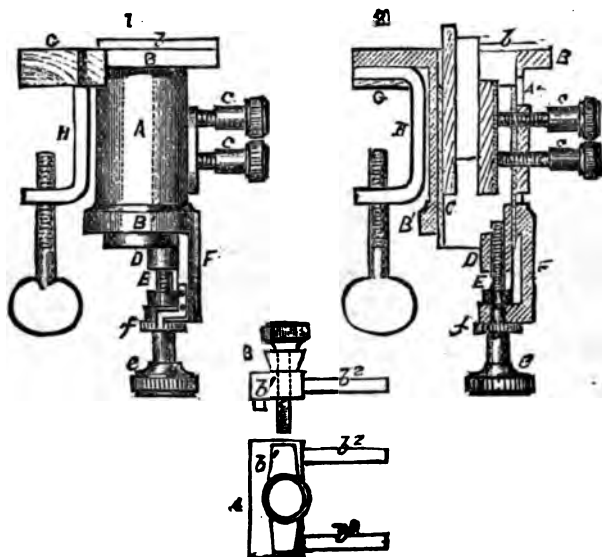

Halles's Microtome.

The two upper figures show the instrument (1) as seen from the side, (2) as seen in section:—A, outer cylinder, carrying upper flange n, on whose surface lie two strips of hard steel, b, b; this flange is fixed to the bar c, which carries a clamp and screw for attaching the Microtome to a table; in the sectional figure (2) is seen the inner tube c, within which the substance to be cut is fixed by the two binding screws, c, c, which work through a slot in the outer cylinder; to the bottom of the inner tube is fixed a block n, through which works the micrometer-screw z, turned by the milled-head e in the bracket f attached to the bottom of the outer cylinder, and having a graduated collar f.

The two lower figures show the additional Saw-guide, seen from the side at 3, and from above at 4:—b, metal block with a screw to secure it on cutting-bed; b', b', steel guides.

instrument, which is made to be held in one hand whilst the section is cut with the other, is its great recommendation.

187. *Imbedding and Freezing Microtomes*.—For making thin sections of *soft* tissues, however, preference is now generally given to Microtomes in which the substance to be cut is so *imbedded* in some material that fills the cylinder, that it does not need to be fixed by binding-screws, being pushed upwards by the action of the micrometer-screw beneath

<sup>1</sup>“Quart. Journ. of Microsc. Science,” Vol. xvii. (1877), p. 85.—Another Microtome, suggested by the preceding, is described by Mr. W. Teesdale in “Journ. of Roy. Microsc. Soc.,” Vol. iii. (1880), p. 1035.



upon the instrument. This plug may be either a cylinder of carrot, turned round a wooden spindle, cut to fit the well of the Microtome, and covered to preserve the substance to be cut; or it may be a *cast* of the substance, made either by pouring into it paraffine or some similar substance (mentioned by Huxley, § 189), or by filling it with thick gum-mucilage which will be rendered dense by cold (§ 191). The latter plan was first invented by Prof. Huxley, whose *Freezing Microtome*, in which the upper part of the specimen is surrounded by a well filled with a freezing-mixture, has now come into general use.—The substitution of ether-spray for the freezing-mixture was suggested by Mr. Bevan Lewis; and an improved model, which can be used either as a Freezing or as an Imbedding Microtome, has been devised by Messrs. Beck. An ingenious method of securing the cutting-blade by a 'parallel motion,' as to make its edge at the same time move tangentially and transversely to the plane of section, has been devised by Prof. Seiler, of Philadelphia, and has found much approval, as well in this country as in the United States.'

FIG. 135.



Bevan Lewis' Microtome.—A, as seen from the front; B, as seen from behind.

*Bevan Lewis' Microtome.*—For the cutting of very thin sections of animal or Vegetable substances which may be advantageously imbedded in paraffine or some other hard fat (§ 189), no instrument is more useful than that represented in Fig. 135, which is known as the 'Bevan Lewis' Microtome. This has for its base an oblong metal plate, from which rises a vertical plate, of which the upper edge is inclined at a gentle angle. From either side of this vertical plate projects a smoothly-planed plate, like a shelf sloping downwards, but while the edge of one of these shelves is parallel to the base, the other is parallel to the inclined margin of the vertical plate. A turning-screw carrier bearing a Knife, the position of which can be adjusted and fixed by means of a binding-screw that works through a slot

in its handle; whilst on the latter there slides an Object-carrier, consisting of a clamp, whose opening is controlled by a binding-screw, for holding the block of paraffine in which the substance to be cut is imbedded. From this description, it will be obvious that when the carrier that bears the knife (as seen at A) is slid from one end of its shelf to the other, the knife always remains on the same level; but that when the Object-carrier is similarly slid (from right to left in Fig. B), it gradually rises, always keeping at the same height in relation to the inclined edge of the vertical plate. This edge being graduated, and a 'vernier' being engraved on the carriage, the progressive elevation of the surface from which the section is to be taken can be measured with the most minute exactness; as the substitution of the inclined plane for the screw altogether does away with the 'lost time' from which the action of the latter is seldom entirely free. The manner in which the knife is attached to its carriage, enables it to be so fixed as to give any proportion that may be desired between the *sliding* and the *pressing* cut.—The simple model here described is extensively used on the Continent; and the Author can indorse its reputation from large personal experience. Certain modifications have been recently made in it, however which must not be passed

FIG. 136.



Improved Object Carrier for the Rivet-Leiser Microtome.

without notice. One of these relates to the mode in which the block of paraffine is held in its carrier, so that the position of the body imbedded in it may be varied, without taking the block out of the clamp. The screw *a* (Fig. 136), working through the fixed piece *b*, brings the movable piece *c* (which is guided by two pins that work through *b*) against the fixed piece *d*, and thus secures the body to be cut. The clamp is connected by means of the bent arm *e* with the block *f*, the upper surface of which is rounded; and on this it can be moved in a plane parallel to the middle plate of the instrument, so as to take a position more or less oblique in which it may be fixed by the binding-screw *g*. The block *f* again is connected with the fixed block *h*, by a pivot passing through the latter; and on this it may be rotated in a plane at right angles to the middle plate, being fixed in any position by the binding-screw *i*. By the combination of these two movements, the object can be placed (and then fixed) in such a position that the sectional plane shall traverse it in any desired direction.—The knife-carrier is also furnished with screws that enable the inclination of the blade to be regulated with great precision. And, if desired, the object-carrier may be advanced up its incline by a screw traversing the entire length of the instrument, instead of by hand; an addition, however, which seems to the Author quite unnecessary, and certainly not worth its cost.<sup>1</sup>—This Microtome can be made in hard wood at a lower cost than in metal, and with very little sacrifice (if any) of efficiency; and it has lately been recommended that the body of the instrument should be divided longitudinally, and its two

<sup>1</sup>"Journ. of Roy. Microsc. Soc.," Vol. ii. (1880), p. 334.

halves attached at one end, but made to diverge at the other at any angle, being there fixed by a clamping screw.<sup>1</sup>

### SECTION 2.—*Preparation and Mounting of Objects.*

189. *Imbedding Processes.*—The preparation of soft Organic substances for Section-cutting by 'imbedding,' may be made in two modes, the choice between which will depend upon the consistence of the substance. If (1) it be compact, like a piece of liver or kidney, it only needs to be *surrounded* by the imbedding mass, which will afford it *as a whole* the requisite support. But if (2) it be partly occupied, like a piece of lung, by interstitial cavities, it must be *penetrated* by the imbedding substance, so that *every part* may be duly supported.—For simple imbedding, nothing is so suitable as the firmer fats; which must not, however, be so hard as to be brittle. Thus, if white Wax be used, it should be melted with an equal weight of olive oil; if Paraffine or Spermaceti, it should be melted with about one-fifth of its weight of lard or soft tallow. The latter is generally to be preferred, as shrinking less in cooling; the cylinder formed by the hardened wax being liable to become loose in the well of the Microtome. Either mixture being kept in stock, carefully secluded from dust, a small quantity of it should be melted for use in a porcelain basin floated in a water-bath. To avoid injury to the tissue, its temperature should not be raised more than is requisite for its thorough liquefaction. The substance to be cut, having been previously hardened (§ 199), should be taken out of the spirit in which it is preserved; and a piece of suitable size having been cut off, this should be placed on blotting-paper, so that the spirit may drain away, and its surface may become dry. It is then to be dipped (as recommended by Dr. Sylvester Marsh), in a very weak solution—20 grains to the ounce—of Gum Arabic, care being taken in doing so not to squeeze out the spirit so as to remoisten the surface; and the superfluous liquid being then again removed by blotting-paper, the surface will in a few minutes become dry and glazed with a thin film of gum, the use of which is to keep the imbedding substance from adhering to it. The plug of the Microtome (which may advantageously have a large-headed screw inserted into its upper side, to furnish a 'hold' for the imbedding substance) being set at the depth of about an inch beneath the cutting-bed, melted wax or paraffine is to be poured into it to about half this depth; and the substance to be cut being then held in the tube in the best position (which is not its centre, but nearer the side next the operator), the imbedding material is to be slowly poured in, until the imbedded substance is entirely covered, and the cavity completely filled. When the imbedding material has become quite solidified by cooling, the cutting of sections may be proceeded with.

190. When, however, it is necessary that the substance to be cut should be entirely *penetrated* by the imbedding material, a much longer preparatory process is necessary. In many cases in which the sections are required to display rather the *general* than the *minute* structure, satisfactory results may be obtained by keeping the substance (previously steeped in pure water) immersed for a lengthened period at a gentle warmth, either in a strong mucilage of Gum Arabic, or in a solution of Gelatine that will 'set' on cooling, its cavities having been laid open

<sup>1</sup> Brandt in "Zeitschrift für Mikrosk.," Bd. ii. (1880), p. 173.

sufficiently for the gradual penetration of the liquid to their interior. The entire mass being then exposed to the air, the slow evaporation of its water will at last reduce it to a consistence sufficiently firm to enable sections of it to be taken; or the water may be drawn out by steeping in Alcohol. This plan has been found to answer for the entire bodies of Insects, Stems of herbaceous Plants, and the like.—But when the sections are to be cut of the extreme thinness required for showing minute histological detail, it is much better to use either Paraffine slightly softened with lard, or Cacao-butter, which last has been much recommended for the imbedding of structures of extreme delicacy. The material to be cut must be first *dehydrated*, or deprived of its Water; which is done by letting it lie for a time in ordinary Spirit, then transferring it to Rectified spirit, and at last treating it with absolute Alcohol. From this it is to be transferred to some volatile oil; oil of bergamot being used for delicate objects; oil of turpentine answering sufficiently well for larger bodies. When this has completely replaced the spirit, the body is to be immersed for some little time in a hot saturated solution of paraffine in oil of turpentine. When it has lain sufficiently long in this to be thoroughly penetrated, it is to be immersed in the melted paraffine, which should not be more heated than is necessary to keep it quite liquid; and it should be moved about in this for some little time, an occasional gentle squeeze being given to it with the forceps, so that the solution may be replaced as completely as possible by the liquefied paraffine. When hardened by cooling, the substance thus prepared may be ‘imbedded’ in any ordinary cylinder Microtome, in the manner already described; the coating with gum being of course omitted. But if the sections are to be made either with the Rivet-Leiser Microtome, or by hand, it is necessary to provide a mould into which the imbedding material can be poured. This may be made of cylindrical form, by twisting a strip of paper round the end of a small ruler; or a brick-shaped block may be cast in a mould made by turning up the edges of a suitably-sized piece of paper, and pinning together the cross-folds at the two ends. But it is generally more convenient to use for this purpose small boxes of tin 2 inches long, and 3-4ths of an inch in breadth and depth, with removable bottoms. A small piece of filtering paper being placed between the bottom and the sides of the box, and the substance to be imbedded being held in it in the most suitable position, the paraffine is poured in until the box is completely filled, and this is set aside to cool. When the paraffine has perfectly solidified, the box is to be lifted off its bottom; and the block, being pushed out of it, is then ready for cutting.—In using the section-knife, care should be taken to keep it constantly wetted with methylated spirit; and it is desirable that each section should be removed from it before another is taken. When, for the study of the anatomy of an animal, sections are being taken *in series*, and it is important that their *order* should be preserved, a set of watch-glasses should be previously provided, each about half filled with spirit, and the sections successively taken should be dropped singly into them; care being taken in the arrangement of the glasses to maintain the relative position of the sections. In order to dissolve out the imbedding material, the sections should be soaked in oil of turpentine with about one-fourth part of creasote; and if its structure is suitable for examination with high powers, it may be cleared by a short immersion in oil of cloves. They are then to be mounted either in Canada balsam solution (§ 209) or in Dammar cement.



191. When the freezing process is employed, the substance to be cut (which may either be fresh, or have been hardened by some of the processes to be hereafter described, § 199) must be thoroughly penetrated by a thick solution of gum; for this, when frozen, does not become crystalline, and may be cut like cheese. If the substance to be cut has been immersed in alcohol, this must be completely removed in the first instance by immersion in water for from six to twenty-four hours, according to the size of the mass; for the gum will not penetrate any part which is still alcoholized. And the substance should be then immersed in the gum-solution for from twelve to twenty-four hours before it is frozen; in order that every part may be permeated by the gum, and no water be left to form crystals of ice. If the freezing Microtome of Prof. Rutherford<sup>1</sup> be employed, the freezing-box should be filled with alternate spoonsful of salt and either snow or finely powdered ice, which are to be stirred round the well previously filled with the gum solution. With the Ether-spray Microtome, the freezing is produced by the rapid evaporation of the liquid injected into the freezing chamber. In either case, the substance to be cut is to be introduced into the well, as soon as the gum begins to harden at its periphery; and should be held in place until fixed by the advancing congelation. In cutting the sections, no wetting of the knife is necessary; as it is kept sufficiently wetted by the thawing gum. The sections should be placed in methylated spirit diluted with twice its volume of water; and this soon not only dissolves out the gum, but removes any air-bubbles the section may contain. If the section is to be at once mounted (which should always be done if it is very delicate and liable to be spoiled by manipulation) it should be placed on a slide before it has thawed, and washed by forming around it a little pool of dilute spirit, which may be readily changed two or three times by the glass syringe (§ 127). Sections cut by the freezing process may for the most part be mounted in glycerine jelly, for which no other preparation will be needed than the use (if desired) of the Staining process hereafter to be described (§ 202). But if, for the sake of rendering the sections more transparent, mounting them in Canada balsam or Dammar is preferred, they must be treated first with strong spirit, then with absolute alcohol, and then with either oil of cloves or oil of turpentine.—It is claimed by Dr. Rutherford as the special advantage of the freezing process, that “delicate organs, such as the retina, the embryo, villi of the intestines, lung, trachea with its ciliated epithelium, may all be readily cut without fear of their being destroyed by the imbedding agent.” When imbedded in paraffine, very delicate structures are more liable to damage; the villi of the intestine, for instance, being often denuded of their epithelium, and sometimes themselves torn.

192. *Grinding and Polishing Sections of Hard Substances.*—Substances which are too hard to be sliced in a Microtome—such as Bones, Teeth, Shells, Corals, Fossils of all kinds, and even some dense Vegetable Tissues—can only be reduced to the requisite thinness for Microscopical examination, by grinding-down thick sections until they become so thin as to be transparent. General directions for making such preparations

---

<sup>1</sup> This instrument has received various improvements since it was first devised, and should be obtained from Mr. Gardner, South Bridge, Edinburgh,—the maker recommended by its inventor. It may be employed also as an ordinary ‘imbedding’ Microtome, when the ‘imbedding’ is thought preferable to the freezing process.

will be here given;<sup>1</sup> but those special details of management which particular substances may require, will be given when these are respectively described.—The first thing to be done will usually be to procure a *section* of the substance, as thin as it can be safely cut. Most substances not siliceous may be divided by the fine Saws used by artisans for cutting brass; and these may be best worked either by a mechanical arrangement such as that devised by Dr. Matthews,<sup>2</sup> or, if by hand, between ‘guides,’ such as are attached for this purpose to Hailes’s and some other Microtomes. But there are some bodies (such as the Enamel of Teeth, and Porcellaneous Shells), which, though merely calcareous, are so hard as to make it very difficult and tedious to divide them in this mode; and it is much the quicker operation to *slit* them with a disc of soft iron (resembling that used by the Lapidary) charged at its edge with diamond-dust, which disc may be driven in an ordinary lathe. Where waste of material is of no account, a very expeditious method of obtaining pieces fit to grind down, is to detach them from the mass with a strong pair of ‘cutting pincers,’ or, if they be of small dimensions, with ‘cutting pliers;’ and a flat surface must then be given to it, either by holding them to the side of an ordinary grindstone, or by rubbing on a plate of lead (cast or planed to a perfect level) charged with emery, or by a strong-toothed file; the former being the most suitable for the *hardest* substances, the latter for the *toughest*. There are certain substances, especially Calcareous Fossils of Wood, Bone, and Teeth, in which the greatest care is required in the performance of these preliminary operations, on account of their extreme friability; the vibration produced by the working of the saw or the file, or by grinding on a rough surface, being sufficient to disintegrate even a thick mass, so that it falls to pieces under the hand; such specimens, therefore, it is requisite to treat with great caution, dividing them by the smooth action of the wheel, and then rubbing them down upon nothing rougher than a very fine ‘grit,’ or on the ‘corundum-files’ now sold in the tool-shops, which are made by imbedding corundum of various degrees of fineness in a hard resinous substance. Where (as often happens) such specimens are sufficiently porous to admit of the penetration of Canada Balsam, it will be desirable, after soaking them in turpentine for a while, to lay some liquid balsam upon the parts through which the section is to pass, and then to place the specimen before a fire or in an oven for some little time, so as first to cause the balsam to run-in, and then to harden it; by this means the specimen will be rendered much more fit for the processes it has afterwards to undergo.—It not unfrequently happens that the small size, awkward shape, or extreme hardness of the body, occasions a difficulty in holding it either for cutting or grinding; in such a case, it is much better to attach it to the glass in the first instance by any side that happens to be flattest, and then to rub it down by means of the ‘hold’ of the glass upon it, until the projecting portion has been brought to a plane, and has been prepared for permanent attachment to the glass. This is the method which it is generally most convenient to pursue with regard to small bodies; and there are many which can scarcely be treated in any other way than by attaching a number of

---

<sup>1</sup> The following directions do not apply to *Siliceous* substances; as sections of these can only be prepared by those who possess a regular Lapidary’s apparatus, and have been specially instructed in the use of it.

<sup>2</sup> “Journ. Quekett Microsc. Club,” Vol. vi. (1890), p. 88.

them to the glass at once, in such a manner as to make them mutually support one another.<sup>1</sup>

193. The mode in which the operation is then to be proceeded with, depends upon whether the section is to be ultimately set up in Canada balsam (§ 210), or is to be mounted 'dry' (§ 169), or in fluid (§ 211). In the former case, the following is the plan to be pursued:—The flattened surface is to be polished by rubbing it with water on a 'Water-of-Ayr' stone, or on a hone or 'Turkey'-stone, or on an 'Arkansas'-stone; the first of the three is the best for all ordinary purposes, but the two latter, being much harder, may be employed for substances which resist it.<sup>2</sup> When this has been sufficiently accomplished, the section is to be attached with hard Canada balsam to a slip of thick well-annealed glass; and as the success of the final result will often depend upon the completeness of its adhesion to this, the means of most effectually securing that adhesion will now be described in detail. The slide having been placed on the cover of the Water-bath, and the previously-hardened balsam having been softened by the immersion of the jar containing it in the bath itself, a sufficient quantity of this should be laid on the slide to form, when spread out by liquefaction, a thick drop somewhat larger than the surface of the object to be attached. The slide should then be allowed to cool, in order that the hardness of the balsam should be tested. If too soft, as indicated by its ready yielding to the thumb-nail, it should be heated a little more, care being taken not to make it boil so as to form bubbles; if too hard, which will be shown by its chipping, it should be re-melted and diluted with more fluid balsam, and then set aside to cool as before. When it is found to be of the right consistence, the section should be laid upon its surface with the polished side downwards; the slip of glass is next to be gradually warmed until the balsam is softened, special care being taken to avoid the formation of bubbles; and the section is then to be gently pressed down upon the liquefied balsam, the pressure being at first applied rather on one side than over its whole area, so as to drive the superfluous balsam in a sort of wave towards the other side, and an equable pressure being finally made over the whole. If this be carefully done, even a very large section may be attached to glass with-

---

<sup>1</sup> Thus, in making horizontal and vertical sections of *Foraminifera*, as it would be impossible to slice them through, they must be laid close together in a bed of hardened Canada Balsam on a slip of glass, in such positions, that when rubbed down, the plane of section shall traverse them in the desired directions; and one flat surface having been thus obtained for each, this must be turned downwards, and the other side ground away. The following ingenious plan was suggested by Dr. Wallich ("Ann. of Nat. Hist., July, 1861, p. 58), for turning a number of minute objects together, and thus avoiding the tediousness and difficulty of turning each one separately:—The specimens are cemented with Canada Balsam, in the first instance, to a thin film of mica, which is then attached to a glass slide by the same means; when they have been ground-down as far as may be desired, the slide is gradually heated just sufficiently to allow of the detachment of the mica-film and the specimens it carries; and a clean slide with a thin layer of hardened balsam having been prepared, the mica-film is transferred to it with the ground surface downwards. When its adhesion is complete, the grinding may be proceeded with; and as the mica-film will yield to the stone without the least difficulty, the specimens, now reversed in position, may be reduced to requisite thinness.

<sup>2</sup> As the *flatness* of the polished surface is a matter of the first importance, that of the Stones themselves should be tested from time to time; and whenever they are found to have been rubbed down on any part more than on another, they should be flattened on a paving-stone with fine sand, or on the lead-plate with emery.



out the intervention of any air-bubbles; if, however, they should present themselves, and they cannot be expelled by increasing the pressure over the part beneath which they are, or by slightly shifting the section from side to side, it is better to take the section entirely off, to melt a little fresh balsam upon the glass, and then to lay the section upon it as before.

194. When the section has been thus secured to the glass, and the attached part thoroughly saturated (if it be porous) with hard Canada balsam, it may be readily reduced in thickness, either by grinding or filing, as before, or, if the thickness be excessive, by taking off the chief part of it at once by the slitting wheel. So soon, however, as it approaches the thinness of a piece of ordinary card, it should be rubbed down with water on one of the smooth stones previously named, the glass slip being held beneath the fingers with its face downwards, and the pressure being applied with such equality that the thickness of the section shall be (as nearly as can be discerned) equal over its entire surface. As soon as it begins to be translucent, it should be placed under the Microscope (particular regard being had to the precaution specified in § 143), and note taken of any inequality; and then, when it is again laid upon the stone, such inequality may be brought down by making special pressure with the forefinger upon the part of the slide above it. When the thinness of the section is such as to cause the water to spread around it between the glass and the stone, an excess of thickness on either side may often be detected by noticing the smaller distance to which the liquid extends. In proportion as the substance attached to the glass is ground away, the superfluous balsam which may have exuded around it will be brought into contact with the stone; and this should be removed with a knife, care being taken, however, that a margin be still left round the edge of the section. As the section approaches the degree of thinness which is most suitable for the display of its organization, great care must be taken that the grinding process be not carried too far; and frequent recourse should be had to the Microscope, which it is convenient to have always at hand when work of this kind is being carried on. There are many substances whose intimate structure can only be displayed in its highest perfection, when a very little more reduction would destroy the section altogether; and every Microscopist who has occupied himself in making such preparations, can tell of the number which he has sacrificed in order to attain this perfection. Hence, if the amount of material be limited, it is advisable to stop short as soon as a *good* section has been made, and to lay it aside—'letting well alone'—whilst the attempt is being made to procure a *better* one; if this should fail, another attempt may be made, and so on, until either success has been attained, or the whole of the material has been consumed—the *first* section, however, still remaining: whereas, if the first, like every subsequent section, be sacrificed in the attempt to obtain perfection, no trace will be left "to show what once has been." In judging of the appearance of a section in this stage under the Microscope, it is to be remembered that its transparence will subsequently be considerably increased by mounting in Canada balsam: this is particularly the case with Fossils to which a deep hue has been given by the infiltration of some coloring matter, and with any substances whose particles have a molecular aggregation that is rather amorphous than crystalline. When a sufficient thinness has been attained, the section may generally be mounted in Canada balsam; and the mode in which this must be managed will be detailed hereafter (§ 210).



195. By a slight variation in the foregoing process, sections may be made of structures, in which (as in Corals) *hard and soft parts are combined*, so as to show both to advantage. Small pieces of the substance are first to be stained thoroughly (§ 202), and are then to be 'dehydrated' by alcohol (§ 190). A thin solution of copal in chloroform is to be prepared, in which the pieces are to be immersed; and this solution is to be concentrated by slow evaporation, until it can be drawn out in threads which become brittle on cooling. The pieces are then to be taken out, and laid aside to harden; and when the copal has become so firm that the edge of the finger-nail makes no impression, they are to be cut into slices, and ground down attached to glass, in the manner already described, the sections being finally mounted in Canada balsam.—The sections (attached to glass) may be partially or completely decalcified, the soft parts remaining *in situ*, by first dissolving out the copal with chloroform; when, after being well washed in water, they should be again stained, and mounted either in weak spirit, or (after having been dehydrated) in Canada balsam.<sup>1</sup>

196. A different mode of procedure, however, must be adopted when it is desired to obtain sections of Bone, Tooth or other finely tubular structures, *unpenetrated* by Canada balsam. If tolerably thin sections of them can be cut in the first instance, or if they are of a size and shape to be held in the hand whilst they are being roughly ground down, there will be no occasion to attach them to glass at all: it is frequently convenient to do this at first, however, for the purpose of obtaining a 'hold' upon the specimen; but the surface which has been thus attached must afterwards be completely rubbed away, in order to bring into view a stratum which the Canada balsam shall not have penetrated. As none but substances possessing considerable toughness, such as Bones and Teeth, can be treated in this manner, and as these are the substances which are most quickly reduced by a coarse file, and are least liable to be injured by its action, it will be generally found possible to reduce the sections nearly to the required thinness, by laying them upon a piece of soft cork or wood held in a vice, and operating upon them first with a coarser and then with a finer file. When this cannot safely be carried farther, the section must be rubbed down upon that one of the fine stones already mentioned (§ 193) which is found best to suit it: as long as the section is tolerably thick, the finger may be used to press and move it; but as soon as the finger itself begins to come into contact with the stone, it must be guarded by a flat slice of cork, or by a piece of gutta-percha, a little larger than the object. Under either of these, the section may be rubbed down to the desired thinness; but even the most careful working on the finest-grained stone will leave its surface, covered with scratches, which not only detract from its appearance, but prevent the details of its internal structure from being as readily made out as they can be in a polished section. This polish may be imparted by rubbing the section with putty-powder (peroxide of tin) and water upon a leather strap, made by covering the surface of a board with buff-leather, having three or four thicknesses of cloth, flannel, or soft leather beneath it: this operation must be performed on both sides of the section, until all the marks of the scratches left by the stone shall have been rubbed out; when the

---

<sup>1</sup> See Koch in "Zoologischer Anzeig.," Bd. i., p. 86.—The Author, having seen (by the kindness of Mr. H. N. Mosely) some sections of Corals prepared by this process, can testify to its complete success.

specimen will be fit for mounting 'dry' after having been carefully cleansed from any adhering particles of putty-powder.

197. *Decalcification*.—When it is desired to examine the structure of the Organic matrix, in which the Calcareous salts are deposited that give hardness to many Animal and to a few Vegetable structures (such as the true Corallines), these salts must be dissolved away by the action of some Mineral Acid, which may be either Nitric or Hydrochloric. This should be employed in a very dilute state, in order that it may make as little change as possible in the soft tissue it leaves behind. When the Lime is in the state of Carbonate (as, for example, in the skeletons of *Echinoderms*, Chap. XIV.), the body to be decalcified should be placed in a glass jar or wide-mouthed bottle holding from 4 to 6 oz. of water, and the acid should be added drop by drop, until the disengagement of air-bubbles shows that it is taking effect; and the solvent process should be allowed to take place very gradually, more acid being added as required. When, on the other hand, much of the lime is in the state of Phosphate, as in Bones and Teeth, the strength of the acid solvent must be increased; and for the hardening of the softer parts of the organic matrix, it is desirable that Chromic acid should be used. In the case of small bones, or delicate portions of large (such as the cochlea of the ear), a half per cent solution of chromic acid will itself serve as the solvent; but larger masses require either Nitric or Hydrochloric acid in addition, to the extent of 2 per cent of the former or 5 per cent of the latter. By some the chromic and the nitric or muriatic acid are mixed in the first instance; while by others it is recommended that the bone should lie first in the chromic acid solution for a week or ten days, and that the second acid should be then added. If the softening is not completed in a month, more acid must be added. When thoroughly decalcified, the bone should be transferred to rectified spirit; and it may then be either sliced in the Microtome, or torn into shreds for the demonstration of its lamellæ.—Acid solvents may also be employed in removing the outer parts of Calcareous skeletons, for the display of their internal cavities (a plan which the Author has often found very useful in the study of *Foraminifera*); or for getting rid of them entirely, so as to bring into complete view any 'internal cast' which may have been formed by the silicification of its originally soft contents (Figs. 332, 337). It has been in this mode, even more than by the cutting of thin sections, that the structure of *Eozoön Canadense* (Plate XVII.) has been elucidated by Professor Dawson and the Author. For the first of these purposes, strong acid should be applied (under the Dissecting Microscope) with a fine camel's hair pencil; and another such pencil charged with water should be at hand, to enable the observer to stop the solvent action whenever he thinks it has been carried far enough. For the second, it is better that the acid should only be strong enough for the *slow* solution of the shelly substance; as the too rapid disengagement of bubbles often produces displacement of delicate parts of the substituted mineral, whilst, if the acid be too strong, the 'internal cast' may be altogether dissolved away.

198. *Preparation of Vegetable Substances*.—Little preparation is required, beyond steeping for a short time in distilled water to get rid of saline or other impurities, for mounting in preservative media specimens of the minuter forms of Vegetable life, or portions of the larger kinds of *Algæ*, *Fungi*, or other succulent Cryptogams. But the Woody structures of *Phanerogams* are often so consolidated by gummy, resinous, or

other deposits, that sections of them should not be cut until they have been *softened* by being partially or wholly freed from these. Accordingly, pieces of stems or roots should be soaked for some days in water, with the aid of a gentle heat if they are very dense, and should then be steeped for some days in methylated spirit, after which they should again be transferred to water. The same treatment may be applied to hard-coated seeds, the 'stones' of fruit, 'vegetable ivory,' and other like substances.—Some Vegetable substances, on the other hand, are too soft to be cut sufficiently thin without previous *hardening*, either by allowing them to lose some of their moisture by evaporation, or by drawing it out by steeping them in spirit. Either treatment answers very well with such substances as that which forms the tuber of the Potato; sections of which display the starch-grains *in situ*. Where, on the other hand, it is desired to preserve color, spirit must not be used; and recourse may be had to Gum-embedding (§ 191), which is particularly serviceable where the substance is penetrated by air-cavities, as is the case with the Stem of the *Rush*, the thick leaves of the *Water-lily*, etc. But where the *staining* process is to be employed (§ 200), the substance should be previously bleached by the action of chlorine (preferably by Labarraque's chlorinated soda), and then treated with Alcohol for a few hours.

199. *Hardening of Animal Substances*.—Save in the case already treated of (§ 192), in which the tissues are consolidated by Calcareous deposit, the preparatory treatment of Animal substances consists in *hardening* them. The very soft tissues of which most of the *lower* Animals are composed, contain so large a proportion of Water, that the withdrawal of this by immersion in strong spirit causes them to shrink so much as completely to obscure their structure. Nothing has yet been found so serviceable in preserving them as *Osmic acid*; the poisonous action of which at once kills living Infusoria, etc., Echinoderm or Annelid larvæ, and the like; and hardens their delicate organisms, so as to allow them to be afterwards stained and preserved with very little change; and thus many points of their structure can be better made out in their 'mounted' than in their living state. The special procedures which have been successfully worked out by M. Certes for *Infusoria*, and by Mr. Percy Sladen for *Echinoderm larvæ*, will be described under those heads.—The hardening of the general body-substance of the larger *Invertebrata* is for the most part sufficiently effected by the action of the Alcoholic spirit in which they are usually preserved; and this may be carried farther, if required, by steeping them for a time in absolute Alcohol. For hardening particular tissues, however, such as Nerves, recourse must be had to some of those *hardening agents*, used in the preparation of the Tissues of the higher Animals, which will be now specified:—

*a. Alcohol*.—For hardening purposes, Rectified spirit should be used in preference to methylated; and its action is (as a rule) most beneficial after some of the other hardening agents have been employed. The substance to be hardened should be first placed for a day or two in a mixture of equal parts of rectified spirit and water, then transferred for about 48 hours to rectified spirit, and from this to absolute alcohol.—One injurious effect of this treatment is, that by the coagulation of their albuminous components many textures are rendered opaque: but, as Dr. Beale pointed out, this may be corrected by the addition of a little caustic Soda, which must be made, however, with great caution.—When the Alcoholic treatment is used merely for so *dehydrating* sections previously immersed in watery solutions, that they may be mounted in Canada balsam or Dammar, they may be transferred at once from rectified spirit to oil of turpentine, without treating them with absolute alcohol.

*b. Chromic Acid*, which is one of the most generally useful of hardening agents, is most conveniently kept in a 1 per cent solution, which may be diluted with several times its volume of water, with or without the addition of spirit. Although its hardening action may be effected by a strong solution in two or three days, it is far better to prolong the process by using the menstruum weak, especially when the substance is in mass; since, if its exterior be so hardened as to prevent the penetration of the fluid, its interior will soften and decay. The following is the mode of procedure most generally approved:—The menstruum having been prepared by mixing two parts of a 1-6th per cent solution of chromic acid and one part of methylated spirit, the material must be cut into small pieces about half an inch square, and put into a wide-mouthed stoppered bottle holding from 6 to 10 ozs. of the fluid; this fluid should be changed at the end of 24 hours, and then every third day; and the material will be probably found sufficiently hardened (which must be ascertained by trying whether a tolerably thin hand-section can be made with a razor) in the course of from 8 to 12 days. If not, the process must be continued, care being taken that it be not so prolonged as to render the substance brittle. The hardening may afterwards be completed by transferring the substance first into dilute and then into stronger spirit; and this will get rid of the color given by the chromic acid, as well as of other flocculent matter. The spirit must be changed as often as it becomes foul and discolored; and when it remains bright and clear, the specimens will be ready for cutting.

*c. Bichromate of Potass*, in a 2 per cent watery solution, may be used where very slow and prolonged hardening is required. With the addition of 1 per cent of sulphate of soda, it constitutes *Müller's Fluid*, which may be conveniently used to harden large pieces that may be left in it for several weeks; no change of the fluid being necessary after the first week.—The hardened substance, after being well washed, is to be treated with spirit, as in the preceding case.

*d. Picric or Carbazotic Acid* is used for the same purposes as Chromic acid; its hardening power is not so great, but it does not shrivel the tissues as much, its action is more rapid, and it may be advantageously used where 'decalcification' is necessary (§ 197). As it is but slightly soluble in water, a cold-water solution must be saturated; and the quantity of liquid should be large in proportion to that of the substance to be acted-on.—Picric acid is used, in combination with Carmine or Aniline-blue, as a staining material (§ 202, *b*).

*e. Kleinenberg's Fluid*.—The following method of preparing delicate and perishable tissues is strongly recommended by Kleinenberg, who has had much experience of it in his investigations on the anatomy of the lower Invertebrata:—To a saturated solution of picric acid in distilled water, add 2 per cent of concentrated sulphuric acid; all the picric acid which is precipitated must be removed by filtration. One part of the filtrate is to be diluted with 3 parts of water; and, finally, as much pure kreosote must be added as will mix. The object to be preserved must remain in this liquid for 3, 4, or more hours; and is then to be transferred for 5 or 6 hours into 70 per cent alcohol, and thence removed into 90 per cent alcohol, which should be changed until it ceases to acquire a yellow tint.

*f. Osmic Acid*—This agent is one of peculiar value to the Microscopist whose studies lie among the lower forms of Animal and Vegetable life; as its application immediately kills them, without producing any retraction or shrinking of their parts, and only not preserves their tissues, but brings out differences in those which might otherwise escape observation. It is sold in the solid state in sealed tubes; and is most conveniently kept as a 1 per cent solution in distilled water. The solution should be preserved in well-stoppered bottles secluded from the light; and should be used with great caution, as it gives forth a pungent vapor which is very irritating to the eyes and nostrils. It is recommended by Dr. Pelletan,<sup>1</sup> M. Certes,<sup>2</sup> and M. Raphael Blanchard,<sup>3</sup> for fixing and preserving Animalcules (*Infusoria* and *Rotifera*), *Desmidiæ*, *Diatomaceæ*, *Bacteria*, and *Vibriones*, etc.; by Dr. Vignal<sup>4</sup> for *Noctiluca*; by Mr. T. Jeffrey Parker<sup>5</sup> for *Entomostraca* and other small *Crustacea*; and it has been successfully used also in the preparation of *Insect* structures. To the Histologist its special value lies in

<sup>1</sup> "Journ. of Roy. Microsc. Soc.," Vol. i. (1878), p. 189.

<sup>2</sup> *Ibid.*, Vol. ii. (1879), p. 331, and 'Comptes Rendus,' 1879, p. 433.

<sup>3</sup> *Ibid.*, Vol. ii. (1879), p. 463.

<sup>4</sup> Robin's "Archives de Physiologie," Tom. xiv. (1878), p. 536.

<sup>5</sup> "Journ. of Roy. Microsc. Soc.," Vol. ii. (1879), p. 331.



THE AGENT AND ITS REVELATIONS.

...the boundary substance of nerve-fibres. ...that time in giving firmness and distinct- ... Various degrees of dilu- ... for these different purposes. ... he has found this Agent very service- ... The acid seems to be ... and these to be decomposed, giv- ... at the same time both ... with per cent. solution of ... answers for ... produced by its use ... the specimens ... strength to

... has been given of late ... by chemi- ... serve ... of complex struc- ... preparations ... The ... staining mat- ... them readily ... by some ... equally permanent. ... water-section-cutting. ... mass, and is not ... made to be ... generally bet- ... sufficiently well ... And if the ... freezing Micro- ... they have been ... would be likely ... has to be ... staining should be ... better than where ... staining fluid should be weak ... stand more equally ... made use of with an ... should be more rapid, and the ... its operation be sure- ... the whole tissue may ... staining altogether lost.

... to carry-on the staining of ... small cups of white porcelain: ... sections together so as to be ... staining from being uniform. ... stained upon the ... a pool of the staining ... when the staining has ... glass Syringe (§ 127). It is even ... covered with thin glass, by ... of the glass cover, and ... staining-paper to the opposite ... while the section is actu- ... the Microscope, the staining liquid

being withdrawn in the same manner when the desired effect has been produced, and being replaced by the preservative medium.—For taking-up sections without injury to them, and transferring them from one vessel to another, recourse may be advantageously had to the 'lifter' of Dr. Sylvester Marsh<sup>1</sup> (Fig. 137); which is a strip of German silver or copper of the thickness of stout cardboard, 7 inches long and 5-8ths inches broad, each end of which, carefully smoothed and rounded, is to be turned at the distance of 5-8ths inch to an angle of about 35°. One end is to be left plain, for lifting the section with some of its fluid, when it is to be deposited on a slide; while the other is perforated for letting the fluid escape, when the section is to be floated-off into a vessel filled with some different fluid.

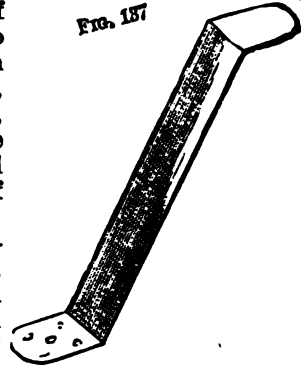

Marsh's Section-Lifter.

202. The relative value of different Staining Agents, the best modes of applying them, and the benefits derivable from their use in the study of the minute structure of Man and the higher Animals,<sup>2</sup> have now been pretty fully determined by Histologists; and considerable progress has also been made in the application of the differential straining process to the various parts of the higher Vegetable fabrics.<sup>3</sup> But there is still a wide field which has been as yet but little cultivated, in the application of the staining process to the study of the lower Organisms of both Kingdoms; and every one who is engaged in the minute investigations of any particular group, must work out for himself the modifications which the ordinary methods may require. All that can be here attempted is to give such directions as to the agents to be employed, and the best modes of using them, as are likely to be most generally useful.

*a. Carmine.*—This was one of the first Dyes employed for staining purposes; and its value was specially insisted on by Dr. Beale, as enabling living Protoplasm (by him designated 'germinal matter,' or 'bioplasm') to be distinguished from any kind of 'formed material.' It has a special affinity for cell-nuclei (protoplasts) and the axial cylinders of white nerve-fibres; and thus, if the substance to be stained be only left in the carmine fluid long enough for it to dye these substances, they are strikingly differentiated from all others. It is essential that the fluid should have a slight alkaline reaction, especially where the substance has been hardened with chromic acid. The presence of too much alkali is injurious; the want of it, on the other hand, causes the dye to act on the tissues generally, and thus negatives its differentiating effect. Dr. Beale directs it to be prepared as follows:—Ten grains of Carmine in small fragments are to be placed in a test-tube, and half a drachm of strong Liquor Ammonia added; by agitation and the heat of a spirit-lamp the carmine is soon dissolved, and the liquid, after boiling for a few seconds, is to be allowed to cool. After the lapse of an hour, much of the excess of ammonia will have escaped; and the solution is then to be mixed with 2 oz. of Distilled Water, 2 oz. of pure Glycerine, and  $\frac{1}{2}$  oz. of Alcohol. The whole may be passed through a filter, or, after being allowed to stand for

<sup>1</sup> See his useful little Treatise on "Section-Cutting."

<sup>2</sup> See the "Treatises on Practical Histology" by Prof. Rutherford, Prof. Schäfer, Dr. Heneage Gibbes, Prof. Ranvier, Prof. Frey, and others; "How to Work with the Microscope" by Dr. Beale; and Davies's "Preparation and Mounting of Microscopic Objects" (2d Edition, edited by Dr. Matthews).

<sup>3</sup> This has been chiefly carried out in the United States by Dr. Beatty, Mr. Walmsley, and Mr. Merriman, whose processes are described in the successive volumes of the "American Journal of Microscopy."

... REVELATIONS.

... fluid may be poured off and kept for ... the carmine should be deposited through ... of a drop or two of Liquor Ammoniac ... recommends that, for slow but more certain ... into a stoppered bottle, so as not to ... be diluted by the addition of from ... as a general stain in 'double ... is made by mixing 30 grains ... of water, and pouring off the ... the stain of murexide the section should be ... of 170 drops of glacial Acetic acid and

... is a very excellent ... purposes. Being ... from Martin ... is filtered into a watch- ... in the solution ... they should not be suf- ... This dye, used ... while other ... be placed in methy- ... and may be afterwards ... stain is removed,

... more generally ... color being more ... as the best mode of ... chloride of calcium in 70 ... from 1 to 3 volumes of a ... and having half-filled a watch- ... concentrated solution of ... the required intensity of ... period varying from a few ... the nature of the tissues composing ... stained throughout, and if ... should retain their color, ... or methylated spirit, ... another formula given ... as obtainable from Martin ... and add 28 cub. centim. ... of spirit. Keep in a ... what remains on the filter be mixed ... after soaking for an hour or two, be ... a second solution will be made as ... are to be diluted with a ... dilution being only to be ... to change by keeping; ... solution, and being deposited on ... deposit of the same kind is ... staining, especially if the process be ... to transfer the specimen to a ... specimens may be treated with ... if the staining has been ... by the Acetic acid mixture ... to be stained with Logwood ... it should be previously

... staining property as carmine; and is ... rapid action and sharp definition ... is liable to fade; and should, there- ... Ordinary magenta fluid may ... magenta crystals in 7 fl. oz. of distilled ... The color of a section stained with ... in a 1-3d per cent watery

... of a beautiful garnet-red color,

should be used in a strong watery solution; and the sections must be well washed in water after staining. Its chief use is in 'double staining' (§ 203).

f. For *blue* and *green* staining, the various *Aniline* dyes are principally used. They are, for the most part, however, rather fugitive in their effects; not forming durable combinations with the tissues they stain. Some of them are soluble in water, others only in spirit; and the selection between the dyes of these two classes will have to be guided by the mode in which the preparations are treated. These dyes are for the most part best fixed by benzole; and as the sections treated with this fluid may be at once mounted in Canada balsam, there is greater probability of their colors being preserved. Besides blue and green, the Aniline series furnishes a deep rich *brown*, known as Bismarck's Brown; and a *blue-black*, which has been recommended for staining nerve-cells.

g. A good *blue* stain (tending to purple) is also given by the substance termed *Indigo-Carmine*; which is particularly recommended for sections of the brain and spinal cord that have been hardened in chromic acid. A saturated solution of the powder in distilled water having been prepared, this may either be used with the addition of about 4 per cent of oxalic acid; or, if an alcoholic fluid be preferred, methylated spirit may be added to the aqueous solution, the mixture being filtered to remove any coloring matter that may have been precipitated. If sections thus stained have an excess of color, this may be removed by the action of a saturated solution of oxalic acid in alcohol.

h. A beautiful *green* hue is given by treating with a saturated solution of Picric acid in water, sections previously stained with Aniline blue; or the two agents may be used together, 4 or 5 parts of a saturated solution of the latter being added to a saturated aqueous solution of the former. This *picro-aniline*, it is believed, may be relied on for permanence; and it acts well in double staining with *picro-carmine*.

i. Two *chemical* agents, Nitrate of Silver and Chloride of Gold, are much used by Histologists for bringing-out particular tissues; the former being especially valuable for the staining of Epithelium-cells; the latter for staining Nerve-cells, Connective-tissue corpuscles, Tendon-cells, and Cartilage-cells. The most advantageous use of these can only be made by the careful observance of the directions which will be found in treatises on Practical Histology.

k. *Molybdate of Ammonia* is recommended as affording a cool blue-gray or neutral-tint *general* stain, which affords a pleasant 'ground' to parts strongly colored by bright *selective* stains.

203. *Double and Triple Staining.*—Very instructive as well as beautiful effects are produced by the simultaneous or successive action of two or three staining fluids; which will respectively pick out (so to speak) the parts of a section for which they have special affinities. Thus, if a section through the base of the tongue of a cat or dog, be stained with *picro-carmine*, *rosein*, and *iodine-green*, the muscles-fibres will take the first, the connective tissue and protoplasm of cells will be colored by the second, while the third will lay hold of the nuclei in the superficial epithelium, serous glands, and non-striated muscle in the vessels; and, further the mucous glands will show a purple formed by the combined action of the red and green (Gibbes).<sup>1</sup> A very striking contrast of the like kind is shown in the double staining of the frond of a Fern with log-wood and aniline blue; the *sori* taking the latter, and standing out brilliantly on the general surface tinged by the former.—The effects produced by using one stain *after* the other, are generally much better than those obtained by simultaneous staining. The selective action of a second stain is not prevented by a previous general staining; for the dye which gives the latter seems to be more weakly held by the parts which take the former, so as to be (as it were) displaced by it. Thus, if a section of a Stem be stained throughout by a solution of Eosin (2 grains to 1 oz.), and be then placed, after washing in strong alcohol, in a half-grain solution of Nichol-

<sup>1</sup> See his "Practical Histology," Chap. v., and his Paper in "Journ. of Roy. Microsc. Soc.," Vol. iii. (1880), p. 390.



son's blue made neutral, the blue will in no long time entirely drive out the red; but by carefully watching the process, it will be seen that the different tissues will change color in different times, the softer cells giving up their red and taking-in the blue more quickly than the harder; so that by stopping the process at the right point (which must be determined by taking-out a section, dipping it in alcohol, and examining it under the microscope), the two kinds of cells are beautifully differentiated by their coloring.<sup>1</sup> The best effects are usually produced by Carmine and Indigo-carmine, Logwood and Picro-carmine, Carmine or Logwood and Aniline-blue or Aniline-green. But very much has yet to be learned on this subject; and the further investigation of it will be likely to produce results that will amply repay the time and labor bestowed.

204. *Chemical Testing*.—It is often requisite, alike in Biological and in Mineralogical investigations, to apply Chemical Tests in minute quantity to objects under Microscopic examination. Various contrivances have been devised for this purpose; but the Author would recommend, from his own experience, the small glass Syringe already described (Fig. 106), with a fine-pointed nozzle, as the most convenient instrument. One of its advantages is the very precise regulation of the quantity of the test to be deposited, which can be obtained by the dextrous use of it; whilst another consists in the power of withdrawing any excess. Care must be taken in using it, to avoid the contact of the test-liquid with the packing of the piston.—Whatever method is employed, great care should be taken to avoid carrying away from the slide to which the test-liquid is applied, any loose particles which may lie upon it, and which may be thus transferred to some other object, to the great perplexity of the Microscopist. For testing Inorganic substances, the ordinary Chemical Reagents are of course to be employed; but certain special Tests are required in Biological investigation, the following being those most frequently required :

a. Solution of *Iodine* in water (1 gr. of iodine, 3 grs. of iodide of potassium, 1 oz. of distilled water) turns *Starch* blue and *Cellulose* brown; it also gives an intense brown to *Albuminous* substances.

b. Dilute *Sulphuric Acid* (one of acid to two or three parts of water), gives to *Cellulose* that has been previously dyed with iodine a blue or purple hue; also, when mixed with a solution of sugar, it gives a rose-red hue, more or less deep, with *Nitrogenous* substances and with bile (Pettenkofer's test).

c. What is known as *Schulze's Test* is a solution of Chloride of Zinc, Iodine, and Iodide of Potassium, made in the following way:—Zinc is dissolved in Hydrochloric acid, and the solution is permitted to evaporate in contact with metallic zinc, until it attains the thickness of a syrup; this syrup is then saturated with iodide of potassium, and iodine is last added. This solution serves like the preceding, to detect the presence of *Cellulose*; and has the advantage over sulphuric acid of being less destructive to the tissues. Each will sometimes succeed where the other fails; consequently, in doubtful cases, both should be employed.

d. Concentrated *Nitric Acid* gives to *Albuminous* substances an intense yellow.

e. *Acid Nitrate of Mercury* (Millon's Test) colors *Albuminous* substances red.

f. *Acetic Acid*, which should be kept both concentrated and diluted with from 3 to 5 parts of water, is very useful to the Animal Histologist from its power of dissolving, or at least of reducing to such a state of transparency that they can no longer be distinguished, certain kinds of membranous and fibrous tissues, so that other parts (especially *nuclei*) are brought more strongly into view.

g. Solution of *Caustic Potass or Soda* (the latter being generally preferable) has a remarkable solvent effect upon many Organic substances, both Animal and Vegetable; and is extremely useful in rendering some structures transparent.

<sup>1</sup> See "Journ. of Roy. Microsc. Soc.," Vol. iii. (1880), p. 694.



while others are brought into view,—its special action being upon *horny* textures, whose component cells are thus rendered more clearly distinguishable.

*h. Ether* dissolves Resins, Fats, and Oils; but it will not act on these through membranes penetrated with watery fluid.

*i. Alcohol* dissolves Resins and some Volatile Oils; but it does not act on ordinary Oils and Fats. It coagulates Albuminous matters, and consequently renders more opaque such textures as contain them. The opacity, however, may be removed by the addition of a small quantity of Soda.

205. *Preservative Media*.—We have now to consider the various modes of preserving the preparations that have been made by the several methods now indicated; and shall first treat of such as are applicable to those minute Animal and Vegetable organisms, and to those Sections or Dissections of large structures, which are suitable for being mounted as *transparent* objects. A broad distinction may be in the first place laid down between *resinous* and *aqueous* preservative media; to the former belong only Canada Balsam and Dammar; whilst the latter include all the mixtures of which Water is component.—The choice between the two kinds of media will partly depend upon the nature of the processes to which the object may have been previously subjected, and partly upon the degree of transparence which may be advantageously imparted to it. Sections of substances which have been not only imbedded in, but penetrated by paraffine, wax, or cacao-butter, and have been stained (if desired) previously to cutting, are, as a rule, most conveniently mounted in Canada balsam or Dammar; since they can be at once transferred to either of these from the menstruum by which the imbedding material has been dissolved-out. The durability of this method of mounting makes it preferable in all cases to which it is suitable; the exception being where it renders a very thin section *too* transparent, which is specially liable to happen with Dammar.—When it is desired to mount in either of these media Sections of structures that have been imbedded in gum or gelatine, these substances must first be completely dissolved-out by steeping in water; the sections must then be ‘dehydrated’ by subjecting them to mixtures of spirit and water progressively increased in strength to absolute alcohol; and after this has been effected, they are to be transferred to turpentine, and thence to benzole. In this process much of the staining is apt to be lost; so that stained sections are often more advantageously mounted in some of those aqueous preparations of Glycerine, which approach the resinous media in transparence and permanence.—When Canada balsam was first employed for mounting preparations, it was employed in its natural semifluid state, in which it consists of a solution of resin in volatile oil of turpentine; and unless a large proportion of the latter constituent was driven off by heat in the process of mounting (bubbles being thus formed of which it was often difficult to get rid), or the mounted slide was afterwards subjected to a more moderate heat of long continuance, the balsam would remain soft, and the cover liable to displacement. This is avoided by the method now generally adopted, of previously getting rid of the turpentine by protracted exposure of the balsam to a heat not sufficient to boil it, and dissolving the resin thus obtained either in benzole or chloroform, the solution being made (with the aid of gentle heat) of such viscosity as will allow it to ‘run’ freely when slightly warmed. Either of these solvents evaporates so much more quickly than turpentine, that the balsam left behind hardens in a comparatively short time.—The *natural* Balsam, however, may be preferably used (with care to avoid the liberation of bubbles by overheating) in mounting sections already cemented to the slides by hardened balsam



(§ 193); and also for mounting the chitinous textures of Insects, which it has a peculiar power of rendering transparent, and which seem to be penetrated by it more thoroughly than they are by the artificially-prepared solution (§ 210).—The solution of Dammar in benzole is very convenient to work with, and hardens quickly.

206. The following are the principal *aqueous* media whose value has been best tested by general and protracted experience:—

*a.* Fresh specimens of minute Protophytes can often be very well preserved in *Distilled Water* saturated with Camphor; the complete exclusion of air serving both to check their living actions and to prevent decomposing changes. When the preservation of color is not a special object, about a tenth part of Alcohol may be added, and this will be found a suitable medium for the preservation of many delicate Animal textures.

*b.* *Aqueous Solution of Carbolic Acid.*—Even the very small quantity of this agent which cold water will take up, has a powerful preservative effect; and the solution may be advantageously employed for mounting preparations of many delicate structures, both Animal and Vegetable.

*c.* The same may be said of *Salicylic Acid*, which has been very successfully employed for delicate preparations in the small proportion that will dissolve in cold water. For coarser structures a stronger solution is preferable; and this may be made by combining with the acid a small quantity either of borax dissolved in glycerine or of acetate of potass.

*d.* Where the preservation of minute histological detail is not so much desired, as the exhibition of larger structural features of objects to be viewed by reflected light, nothing is better than *Dilute Spirit*; the proportion most generally serviceable being 1 of Alcohol to 4 or 5 of water; and an even weaker mixture serving to prevent further change in tissues already hardened by strong Alcohol. The Author has a series of the beautiful Pentacrinoid larvæ of *Comatula* (Plate XXI.) thus preserved in cells twenty years ago; which are as perfect as when first mounted. These weaker mixtures have no action on Gold-Size.

Of late years, *Glycerine* has been largely used as a preservative; either alone, according to the method of Dr. Beale (§ 208), or diluted with water, or mixed with gelatinous substances.—It is much more favorable to the preservation of color than most other media; and is therefore specially useful as a constituent of fluids used for mounting Vegetable objects in their natural aspects. It has also the property of increasing the transparency of Animal structures, though in a less degree than resinous substances; and may thus be advantageously employed as a component of media for mounting objects that are rendered too transparent by Balsam or Dammar.—Two cautions should be given in regard to the employment of Glycerine; *first*, that, as it has a solvent power for Carbonate of Lime, it should not be used for mounting any object having a calcareous skeleton; and *second*, that in proportion as it increases the transparency of organic substances, it diminishes the reflecting power of their surfaces, and should never be employed, therefore, in the mounting of objects to be viewed by *reflected* light, although many objects mounted in the media to be presently specified are beautifully shown by 'black-ground' illumination.

*e.* A mixture of one part of Glycerine and two parts of Camphor-water may be used for the preservation of many Vegetable structures.

*f.* For preserving soft and delicate Marine Animals which are shrivelled-up, so to speak, by stronger agents, the Author has found a mixture of 1 part of Glycerine and 1 of Spirit with 8 or 10 parts of Sea Water, the most suitable preservative.

*g.* For preserving minute Vegetable preparations, the following method, devised by Hantzsch, is said to be peculiarly efficient:—A mixture is made of 3 parts of pure Alcohol, 2 parts of Distilled Water, and 1 part of Glycerine; and the object, laid in a cement-cell, is to be covered with a drop of this liquid, and then put aside under a bell-glass. The Alcohol and Water soon evaporate, so that the Glycerine alone is left; and another drop of the liquid is then be added, and a



second evaporation permitted; the process being repeated, if necessary, until enough Glycerine is left to fill the cell, which is then to be covered and closed in the usual mode.<sup>1</sup>

*h.* The *Glycerine Jelly* prepared after the manner of Mr. Lawrence may be strongly recommended as suitable for a great variety of objects, Animal as well as Vegetable, subject to the cautions already given:—"Take any quantity of Nelson's Gelatine, and let it soak for two or three hours in cold water, pour off the superfluous water, and heat the soaked gelatine until melted. To each fluid ounce of the Gelatine add one drachm of Alcohol, and mix well; then add a fluid drachm of the white of an egg. Mix well while the Gelatine is fluid, but cool. Now boil until the albumen coagulates, and the Gelatine is quite clear. Filter through fine flannel, and to each fluid ounce of the clarified Gelatine add six fluid drachms of Price's pure Glycerine, and mix well. For the six fluid drachms of Glycerine, a mixture of two parts of Glycerine to four of Camphor-water may be substituted. The objects intended to be mounted in this medium are best prepared by being immersed for some time in a mixture of one part of Glycerine with one part of diluted Alcohol (1 of alcohol to 6 of water)."<sup>2</sup> A small quantity of Carboic acid may be added to it with advantage. When used, the jelly must be liquefied by gentle warmth, and it is useful to warm both the slide and the cover-glass previously to mounting.—This takes the place of what was formerly known as Deane's Medium, in which honey was used to prevent the hardening of the gelatine.

*i.* For objects which would be injured by the small amount of heat required to liquefy the last-mentioned medium, the *Glycerine and Gum* Medium of Mr. Farrants will be found very useful. This is made by dissolving 4 parts (by weight) of picked Gum Arabic in 4 parts of cold Distilled Water, and then adding 2 parts of Glycerine. The solution must be made without the aid of heat, the mixture being occasionally stirred, but not shaken, whilst it is proceeding; after it has been completed, the liquid should be strained (if not perfectly free from impurity) through fine cambric previously well washed out by a current of clean cold water; and it should be kept in a bottle closed with a glass stopper or cap (not with cork), containing a small piece of Camphor.—The great advantage of this Medium is that it can be used cold, and yet soon viscidifies without cracking; it is well suited to preserve delicate Animals as well as Vegetable tissues, and in most cases increases their transparence.

It often is quite impossible to predicate beforehand what preservative medium will answer best for a particular kind of preparation; and it is consequently desirable, where there is no lack of material, to mount similar objects in two or three different ways, marking on each slide the method employed, and comparing the specimens from time to time, so as to judge the condition of each.

207. In dealing with the small quantities of fluid media required in mounting Microscopic objects, it is essential for the operator to be provided with the means of transferring very small quantities from the vessels containing them to the slide, as well as of taking up from the slide what may be lying superfluous upon it. Where some one fluid, such as Diluted Alcohol or the Carboic acid solution, is in continual use, it will be found very convenient to keep it in the small Dropping-bottle represented in Fig. 138. The stopper is perforated, and is elongated below into a fine tube, whilst it expands above into a bulbous funnel, the mouth of which is covered with a piece of thin Vulcanized India-rubber tied firmly round its lip. If pressure be made on this cover with the point of the finger, and the end of the tube be immersed in the liquid, in the bottle,

<sup>1</sup> See the Rev. W. W. Spicer's "Handy-book to the Collection and Preparation of Freshwater and Marine Algæ, etc.," pp. 57-59. "Nothing," says Mr. Spicer, "can exceed the beauty of the preparations of *Desmidiaceæ* prepared after Herr Hantzsch's method; the form of the plant and the coloring of the endochrome having undergone no change whatever."

<sup>2</sup> A very pure Glycerine jelly, of which the Author has made considerable use, is prepared by Mr. Rimmington, chemist, Bradford, Yorkshire.



this will rise into it on the removal of the finger; if, then, the funnel be inverted, and the pressure be re-applied, some of the residual air will be forced out, so that by again immersing the end of the tube, and removing the pressure, more fluid will enter. This operation may be repeated as often as may be necessary, until the bulb is entirely filled; and when it is thus charged with fluid, as much or as little as may be needed is then readily expelled from it by the pressure of the finger on the cover, the bulb being always refilled if care be taken to immerse the lower end

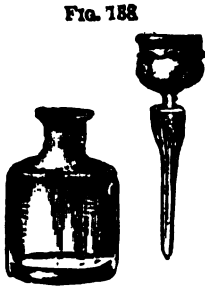

Fig. 188  
Dropping-Bottle.

of the tube before the pressure is withdrawn. The Author can speak from large experience of the value of this little implement; as he can also of the utility of the small Glass Syringe (§ 127) for the same purpose, and this not only for fine Aqueous liquids, but also for Glycerine jelly, and Canada balsam. For these media having been poured, when liquefied by warmth, each into its own syringe (its piston having been previously drawn out), can be forced out as occasion requires, by pressure on the replaced piston, which may be graduated with great nicety, when the syringe has been gently warmed by lying for a short time on the Water-bath cover (§ 177). Farrants's medium may be conveniently used in the same manner.

But the solutions of Canada Balsam and Gum Dammar in volatile fluids will not be sufficiently secure from change by evaporation through the point of the syringe; and are better kept in wide-mouthed *capped* jars, the liquid being taken-out on a pointed glass rod, or 'stirrer' cut to such a length as will enable it to stand in the jar when its cap is in place.—Great care should be taken to keep the inside of the cap and the part of the neck of the jar on which it fits, *quite clean*, so as to prevent the fixation of the neck by the adhesion between these two surfaces. Should such adhesion take place, the cautious application of the heat of a spirit-lamp will usually make the cap removable. In taking out the liquid, care should be taken not to drop it prematurely from the rod,—a mischance which may be avoided by not taking up more than it will properly carry, and by holding it in a horizontal position, after drawing it out of the bottle, until its point is just over the slip or cover on which the liquid is to be deposited.

208. *Mounting Thin Sections.*—The thin sections cut by the Microtome, or membranes obtained by Dissection, do not require to be placed in cells when mounted in any viscid medium; since its tenacity will serve to keep off injurious pressure by the cover-glass. When the preparation has been previously immersed in Aqueous liquids, and is to be mounted in glycerine, glycerine jelly, or Farrants's medium, the best mode of placing it on the slide is to float it in a saucer or shallow capsule of water, to place the slide beneath it, and, when the object lies in a suitable position above it, to raise the slide cautiously, holding the object in place by a needle, until it is entirely out of water. The slide is then to be wiped by an absorbent cloth, taking care not to touch the object with it; and the small quantity of liquid still surrounding the object is to be carefully drawn off by a bit of blotting-paper, care being taken not to touch the object with it (as its fibres are apt to adhere), or to leave any loose fibres on the side. Before the object is covered, it should be looked at under a Dissecting or Mounting Microscope, for the purpose of improving (if desirable) its disposition on the slide, and of removing any foreign particles

that may be accidentally present. A drop of the medium (liquefied, if necessary by a gentle warmth) is then to be placed upon it, and another drop placed on the cover and allowed to spread out. The cover being then taken up with a pair of forceps, must be inverted over the object, and brought to touch the slide at one part of its margin; the slide being itself inclined in the direction of the place of contact, so that the medium accumulates there in a little pool. By gently letting down the cover, a little wave of the medium is pressed before it; and, if enough of the medium has been deposited, the whole space beneath the cover will be filled, and the object completely saturated. If air-bubbles should unfortunately show themselves, the cover must be raised at one margin, and a further quantity of the medium deposited. If, again, there are no air-bubbles, but the medium does not extend itself to the edge of the cover, the cover need not be raised, but a little may be deposited at its edge, whence it will soon be drawn in by capillary attraction, especially if a gentle warmth be applied to the slide. It will then be advantageous again to examine the preparation under the Dissecting Microscope, for it will often happen that an opportunity may thus be found of spreading it better, by the application of gentle pressure to one part or another of the covering-glass, which may be done without injurious effect either with a stiff needle or by a pointed stick, a method whose peculiar value, when viscid media are employed, was first pointed out by Dr. Beale.—The slide should then be set aside for a few days, after which its mounting may be completed. Any excess of the medium must first be removed. If Glycerine has been employed, much of it may be drawn off by blotting-paper (taking care not to touch the edge of the cover, as it will be very easily displaced); and the remainder may be washed away with a camel-hair brush dipped in water, which may be thus carried to the edge of the cover. The water having been drawn off, a narrow ring of liquefied glycerine-jelly may be made *around—not on*—the margin of the cover (according to the suggestion of Dr. S. Marsh) for the purpose of fixing it before the cement is applied; and when this has set, the slide may be placed on the Turn-table (§ 176), and the preparation 'sealed' by a ring either of Dammar or of Bell's cement, which should be carried a little *over* the edge of the cover, and outside the margin of the ring of glycerine-jelly. This 'ringing' should be repeated two or three times; and if the preparation is to be viewed with 'oil-immersion' lenses, it should be finished off with a coat of Hollis's glue, which is not attacked by cedar-oil. Until the cover has been perfectly secured, a slide carrying a glycerine preparation should never be placed in an inclined position, as its cover will be almost sure to slide by its own weight.—If Glycerine-jelly or Farrants's medium have been employed, less caution need be used, as the cover-glass, after a few days' setting, will adhere with sufficient firmness to resist displacement. The superfluous medium having been removed by the cautious use of a knife, the slide and the margin of the cover may be completely cleansed by a camel-hair brush dipped in warm water; and when quite dried, the slide, placed on the Turn-table, may be sealed with Gold-size, —any other Cement being afterwards added either for additional security or for 'appearance.'

209. When, on the other hand, the Section or other preparation is to be mounted in a Resinous medium, it must have been previously prepared for this in the modes already described (§§ 190, 191), which will present it to the mounter either in Turpentine or some other essential oil, or in Alcohol. From either of these it may be transferred to the slide by the



'lifter' (§ 201); its unperforated end being employed, so as to carry with the object a small pool of the fluid from which it has been taken.—This will greatly facilitate the transfer of the object from the lifter to the slide; as it may be readily floated off with the aid of a slight touch of a needle. The fluid thus deposited with it having been drained away by blotting-paper, the object may be treated (if desirable for thoroughly clearing it) with a drop of Clove-oil, which should be deposited, not *on* the object, but *near* it, and made to run to it by inclining the slide, so as, by running *under* it, to rise through it and saturate it thoroughly. After about two minutes, the clove-oil is to be drained away, and the Balsam or Dammar solution applied by the glass rod; one drop being placed on the object, and another on the cover, which is then to be turned and lowered-down on the object in the manner already described. The presence of a few air-bubbles may be here disregarded, as they will ultimately disappear; but care must be taken that the resinous solution not only fills the space between the cover and the slide, but extends beyond its entire margin, as much shrinkage will be produced by the evaporation of the solvent. If this precaution be attended-to, and 'appearance' is not a serious consideration, nothing more is requisite for the protection of the preparation; since the margin of resin left by the evaporation of its solvent forms an adequate cement, especially if the cover be secured by gummed-paper from being loosened by a 'jar.' But if it be desired to replace this by a black or colored cement,<sup>1</sup> the resin must first be scraped away with the edge of an awl<sup>2</sup> carried *along* (not towards) the margin of the cover; and the slide, being then cleaned with benzole, and finally wiped with methylated spirit, may finally be 'ringed' on the Turn-table.

210. *Mounting Objects in Canada Balsam.*—Although it is preferable for Histological purposes to employ a solution of hardened Balsam, yet as there are many objects for mounting for which the use of the 'natural' Balsam is preferable, it will be well to give some directions for its use.—When Sections of hard substances have been ground down on the slides to which they have been cemented (§ 194), it is much better that they should be mounted without being detached, unless they have become clogged with the abraded particles, and require to be cleansed out—as is sometimes the case with sections of the shells, spines, etc., of Echinoderms, when the balsam by which they have been cemented is too soft. If the detachment of a specimen be desirable, it may be loosened by heat, and lifted off with a camel-hair brush dipped in Oil of Turpentine. But, where time is not an object, it is far better to place the slide to steep in Ether or Chloroform in a capped jar, until the object then falls off of itself by the solution of its cement. It may be thoroughly cleansed by boiling it in methylated spirit, and afterwards laid upon a piece of blotting-paper to dry; after which it may be mounted in fresh balsam on a slide, just as if it had remained attached. The slide having been warmed on the water-bath lid, a sufficient quantity of balsam should be pressed out from the syringe on the object; and care should be taken that this, if previously loosened, should be thoroughly penetrated by it. If any air-bubbles arise, they should be broken with the needle-point.

<sup>1</sup> The great Scientific investigators of Germany, who cut an entire Worm into thin transverse sections, carefully mounted in their order, would scorn to spend time in such a mere 'finish,' which they would consider only worthy of Amateurs.

<sup>2</sup> The Author has found this implement, mounted in a *small* handle, far less liable to disturb the cover, than the 'old penknife,' the slipping of whose point in chipping-away hard resin has oftentimes occasioned him much mischief.



The cover having been similarly warmed, a drop of balsam should be placed on it, and made to spread over its surface; and the cover should then be turned over and let down on the object in the manner already described. If this operation be performed over the water-bath, instead of over the spirit-lamp, there will be little risk of the formation of air-bubbles. However large the section may be, care should be taken that the Balsam is well-spread both over its surface and that of its cover; and by attending to the precaution of making it accumulate on one side by sloping the slide, and letting down the cover so as to drive a wave before it to the opposite side, very large sections may thus be mounted without a single air-bubble. (The author has thus mounted sections of *Eozoon* three inches square.)—In mounting minute Balsam-objects, such as *Diatoms*, *Polycystina*, *Sponge-spicules*, and the beautiful minute spines of *Ophiurida*, great advantage will be obtained from following the plan suggested by Mr. James Smith, for which his Mounting Instrument (Fig. 130) is specially adapted. The slide being placed upon its slide-plate, and the object having been laid upon the glass in the desired position, the covering glass is laid upon this, and the ivory knob is to be screwed down, so as, by a very slight pressure on the cover, to keep in its place. The slide is then to be *very gently* warmed, and the Balsam to be applied at the edge of the cover, from which it will be drawn in by capillary attraction, penetrating the objects, and leaving no bubbles if too much heat be not applied. In this manner the objects are kept exactly in the places in which they were at first laid; and scarcely a particle of superfluous balsam, if due care has been employed, remains on the slide.—When the chitinous textures of Insects are to be thus mounted, they must be first softened by steeping in Oil of Turpentine; and a large drop of Balsam being placed on a warmed slide, the object, taken up in the forceps, is to be plunged in it, and the cover (balsamed as before) let down upon it. It is with objects of this class, that the *Spring-Clip* (Fig. 128) and the *Spring-Press* (Fig. 129) prove most useful in holding down the cover until the balsam has hardened sufficiently to prevent its being lifted by the elasticity of the object.—Various objects (such as the palates of Gasteropods), which have been prepared by dissection in water or weak spirit, may be advantageously mounted in Balsam; for which purpose they must be first dehydrated, and then transferred from rectified Spirit into Turpentine. *Carbolic Acid* liquefied by heat has been lately recommended by Dr. Ralph<sup>1</sup> as most efficient in drawing out water from specimens to be mounted in Balsam or Dammar, which afterwards readily take its place.—Sections of Horns, Hoofs, etc., which afford most beautiful objects for the Polariscopes, are best mounted in natural Balsam, which has a remarkable power of increasing their transparence.—It is better to set aside in a warm place the slides which have been thus mounted, before attempting to clean off the superfluous Balsam; in order that the covers may be fixed by the gradual hardening of what lies beneath them.

211. *Mounting Objects in Aqueous Liquids*.—By far the greater number of preparations which are to be preserved in liquid, however, should be mounted in a Cell of some kind, which forms a *well* of suitable depth, wherein the preservative liquid may be retained. This is *absolutely necessary* in the case of all objects whose thickness is such as to prevent

<sup>1</sup> See the account of Dr. Ralph's method in "Journ. of Roy. Microsc. Soc.," Vol. iii. (1880), p. 858.



the glass-cover from coming into close approximation with the slide; and it is *desirable* whenever that approximation is not such as to cause the cover to be drawn to the glass-slide by capillary attraction, or whenever the cover is *sensibly* kept apart from the slide by the thickness of any portion of the object. Hence it is only in the case of objects of the most extreme tenuity, that the Cell can be advantageously dispensed with; the danger of *not* employing it, in many cases in which there is no difficulty in mounting the object without it, being that after a time the cement is apt to run-in beneath the cover, which process is pretty sure to continue when it may have once commenced. When Cement-cells (§ 170) are employed for this purpose, care must be taken that the surface of the ring is perfectly flat, so that when the cover-glass is laid-on, no tilting is produced by pressure on any part of its margin. As a general rule it is desirable that the object to be mounted should be steeped for a little time previously in the preservative fluid employed.—A sufficient quantity of this fluid being deposited from the Syringe or Dropping-bottle to over-fill the cell, the object is to be introduced into it either with the Forceps or the Dipping-tube (§ 126); and the slide should then be examined on the Dissecting Microscope, that its entire freedom from foreign particles and from air-bubbles may be assured, and that its disposition may be corrected if necessary. The cover should then be laid on very cautiously, so as not to displace the object; which in this case is best done by keeping the drop-highest in the centre, and keeping the cover parallel to the slide whilst it is being lowered, so as to expel the superfluous fluid *all around*. This being taken up by the syringe, the cement ring and the margin of the cover are to be dried with blotting-paper, especial care being taken to avoid drawing-off too much liquid, which will cause the gold-size to run-in. It is generally best to apply the first coat of Gold-size *thin*, with a very small and flexible brush worked with the hand; this will dry sufficiently in an hour or two, to hold the cover whilst being 'ringed' on the Turn-table. And it is safer to apply a third coat a day or two afterwards: *old* Gold-size, which lies thickly, being then applied so as to raise the the ring to the level of the surface of the cover. As experience shows that preparations thus mounted, which have remained in perfectly good order for many years, may be afterwards spoiled by leakage, the Author strongly recommends that to prevent the loss of valuable specimens, an additional coating of gold-size be laid-on from time to time.

212. *Mounting of Objects in Deep Cells.*—The objects which require deep cells are, as a rule, such as to be viewed by reflected light; and are usually of sufficient size and substance to allow of air being entangled in their tissues. This is especially liable to occur where they have undergone the process of decalcification (§ 198); which will very probably leave behind it bubbles of Carbonic acid. For the extraction of such bubbles, the use of an Air-pump is commonly recommended; but the Author has seldom found this answer the purpose satisfactorily, and is much disposed to place confidence in a method lately recommended—steeping the specimen in a stoppered jar filled with *freshly boiled water*, which has great power of drawing into itself either Air or Carbonic acid. Where the structure is one which is not injured by Alcohol, prolonged steeping in this will often have the same effect.—The next point of importance is to select a cover of a size exactly suitable to that of the ring, of whose breadth it should cover about two-thirds, leaving an adequate margin uncovered for the attachment of the cement. And the perfect flatness of that ring should then be carefully tested, since on this mainly depends

the security of the mounting. It is to secure this, that the Author prefers rings of *tin* (§ 171) to those of glass, for cells of moderate depth; for their surface can be easily made perfectly flat by grinding with water, first on a piece of grit, and then on a Water-of-Ayr stone—these stones having been previously reduced to a plane surface (§ 193). If glass rings are not found to be ‘true’ they must be ground-down with fine emery on a plate of lead. When the cell has been thus finished-off, it must be carefully cleaned-out by syringing into it some of the mounting-fluid; and should be then examined under the Dissecting Microscope for minute air-bubbles, which often cling to the bottom or sides. These having been got rid of by the needle, the cell should be finally filled with the preservative liquid, and the object immersed in it, care being taken that no air-bubbles are carried-down beneath it. The cell being completely filled so that the liquid is running over its side, the cover may then be lowered down upon it as in the preceding case; or, if the cell be quadrangular, the cover may be sloped so as to rest one margin on its wall and fresh liquids may be thrown in by the Syringe, while the other edge is lowered. When the cover is in place, and the liquid expelled from it has been taken up by the syringe, it should again be examined under a lens for air-bubbles; and if any of these troublesome intruders should present themselves beneath the cover, the slide should be inclined, so as to cause them to rise towards the highest part of its circumference, and the cover slipped away from that part, so as to admit of the introduction of a little additional fluid by the pipette or syringe; and when this has taken the place of the air-bubbles, the cover may be slipped back into its place. The surface of the ring and the edge of the cover must then be thoroughly dried with blotting-paper, care being taken that the fluid be not drawn away from between the cover and the edge of the cell on which it rests. These minutiae having been attended to, the closure of the cell may be at once effected by carrying a thin layer of Gold-size or Dammar around and upon the edge of the glass-cover, taking care that it touches every point of it, and fills the angular channel which is left along its margin. The Author has found it advantageous, however, to delay closing the cell for some little time after the superfluous fluid has been drawn off; for as soon as evaporation from beneath the edge of the cover begins to diminish the quantity of fluid in the cell, air-bubbles often begin to make their appearance, which were previously hidden in the recesses of the object; and in the course of half an hour, a considerable number are often collected. The cover should then be slipped aside, fresh fluid introduced, the air-bubbles removed, and the cover put on again; and this operation should be repeated until it fails to draw forth any more air-bubbles. It will of course be observed, that if the evaporation of fluid should proceed far, air-bubbles will *enter* beneath the cover; but these will show themselves on the *surface* of the fluid; whereas those which arise from the object itself are found in the deeper parts of the cell. When all these have been successfully disposed of, the cell may be ‘sealed’ and ‘ringed’ in the manner already described.

213. *Importance of Cleanliness.*—The success of the result of any of the foregoing operations is greatly detracted-from, if, in consequence of the adhesion of foreign substances to the glasses whereon the objects are mounted, or to the implements used in the manipulations, any extraneous particles are brought into view with the object itself. Some such will occasionally present themselves, even under careful management; especially fibres of silk, wool, cotton, or linen, from the handkerchiefs, etc.,

with which the glass-slides may have been wiped; fibres of the blotting-paper employed to absorb superfluous fluid; and grains of starch, which often remain obstinately adherent to the thin glass-covers kept in it. But a careless and uncleanly manipulator will allow his objects to contract many other impurities than these; and especially to be contaminated by particles of dust floating through the air, the access of which may be readily prevented by proper precautions. It is desirable to have at hand a well-closed cupboard furnished with shelves, or a cabinet of well-fitted drawers, or a number of bell-glasses upon a flat table, for the purpose of securing glasses, objects, etc., from this contamination in the intervals of the work of preparation; and the more readily accessible these receptacles are, the more use will the Microscopist be likely to make of them. Great care, ought, of course, to be taken that the Media employed for mounting should be freed by effectual filtration from all floating particles, and that they should be kept in well-closed bottles.

214. *Labelling and Preserving of Objects.*—Whenever the mounting of an object has been completed, its name ought to be *at once* marked on it, and the slide should be put away in its appropriate place. Some inscribe the name on the glass itself with a writing diamond; whilst others prefer to gum a labels' on the slide; and others, again, cover one or both surfaces of the slide with colored paper, and attach the label to it. In the case of objects mounted dry or in balsam, the latter method has the advantage of rendering the glass-cover more secure from displacement by a slight blow or 'jar' when the varnish or balsam may have become brittle by the lapse of years. Instead, however, of attaching the white label on which the name of the object is written, to the outside of the colored paper with which the slide is covered, it is better to attach the label to the glass, and to punch a hole out of the colored paper, sufficiently large enough to show the name, in the part corresponding to it: in this manner the label is prevented from falling-off, which it frequently does when attached to the glass without protection, or to the outside of the paper cover. When objects are mounted in fluid, either with or without cells, paper coverings to the slides had better be dispensed with; and besides the name of the object, it is desirable to inscribe on the label that of the fluid in it is mounted.—For the preservation of objects, the pasteboard boxes now made at a very reasonable cost, with wooden racks, to contain 6, 12, or 24 slides, will be found extremely useful. In these, however, the slides must always stand upon their edges; a position which, besides interfering with that ready view of them which is required for the immediate selection of any particular specimen, is unfavorable to the continued soundness of preparations mounted in fluid. Although such boxes are most useful, indeed almost indispensable, to the Microscopist, for holding slides which he desires (for whatever purpose) to keep for awhile constantly at hand, yet his regularly-classified series is much more conveniently stored either in a Cabinet containing numerous very shallow drawers, in which they lie flat and exposed to view, or (which the Author finds much preferable) in a series of smaller cases, each holding a dozen trays, every one of which is divided into twelve compartments for as many slides. These have the advantage, not only of cheapness (their outside case being made of polished pine, while the trays are made of thin pasteboard glued to a wooden

<sup>i</sup> Very neat gummed labels, of the various sizes and patterns suitable to the wants of the Microscopist, may be obtained from the "Drapers' Stationers" in the City; and covering slips of various patterns are supply by many of the dealers in Microscopic Apparatus.



framing) but also of facilitating the classification of Objects in groups, and of enabling any particular series to be transported without risk of injury, every slide being lodged in its own receptacle. Further, when provision has to be made for slides requiring greater depth than usual (such, for instance, as extra-thick wooden slides, or glasses bearing deep cells), trays can be made either of double the usual depth, or in the proportion of 3 to 2 (two such trays equalling three ordinary ones in thickness), so as still, by keeping the case filled, to prevent shake to its content when it is carried. Smaller Slide-cases of the same kind, containing from two to six trays, each of which holds six slides, are made for the pocket.

### Section 3. *Collection of Objects.*

215. A large proportion of the objects with which the Microscopist is concerned, are derived from the minute parts of those larger organisms, whether Vegetable or Animal, the collection of which does not require any other methods than those pursued by the ordinary Naturalist. With regard to such, therefore, no special directions are required. But there are several most interesting and important groups both of Plants and Animals, which are themselves, on account of their minuteness, essentially *microscopic*; and the collection of these requires peculiar methods and implements, which are, however, very simple,—the chief element of success lying in the knowledge *where* to look and *what* to look for. In the present place, *general* directions only will be given; particular details relating to the several groups, being reserved for the account to be hereafter given of each.

216. Of the Microscopic organisms in question, those which inhabit fresh water must be sought for in pools, ditches, or streams, through which some of them freely move; whilst others attach themselves to the stems and leaves of aquatic Plants, or even to pieces of stick or decaying leaves, etc., that may be floating on the surface or submerged beneath it; while others, again, are to be sought for in the muddy sediments at the bottom. Of those which have the power of free motion, some keep near the surface, whilst others swim in the deeper waters; but the situation of many depends entirely upon the light, since they rise to the surface in sunshine, and subside again afterwards. The Collector will, therefore, require a means of obtaining samples of water at different depths, and of drawing to himself portions of the larger bodies to which the microscopic organisms may be attached. For these purposes nothing is so convenient as the *Pond-Stick* (sold by Mr. Baker), which is made in two lengths, one of them sliding within the other, so as when closed to serve as a walking-stick. Into the extremity of this may be fitted, by means of a screw socket, (1) a cutting-hook or curved knife, for bringing up portions of larger Plants in order to obtain the minute forms of Vegetable or Animal life that may be parasitic upon them; (2) a broad collar, with a screw in its interior, into which is fitted one of the screw-topped Bottles made by the York Glass Company; (3) a ring or hoop for a muslin Ring-Net. When the Bottle is used for collecting at the surface, it should be moved sideways with its mouth partly below the water; but if it be desired to bring up a sample of the liquid from below, or to draw into the bottle any bodies that may be loosely attached to the submerged plants, the bottle is to be plunged into the water with its mouth downwards, carried into the situation in which it is desired that it should be filled, and then suddenly turned with its mouth upwards. By unscrew-



ing the bottom from the collar, and screwing on its cover, the contents may be securely preserved. The Net should be a bag of fine muslin, which may be simply sewn to a ring of stout wire. But it is desirable for many purposes that the muslin should be made removable; and this may be provided for (as suggested in the "Micrographic Dictionary," Introduction, p. xxiv.) by the substitution of a wooden hoop grooved on its outside, for the wire ring; the muslin being strained upon it by a ring of vulcanized India-rubber, which lies in the groove, and which may be readily slipped off and on, so as to allow a fresh piece of muslin to be put in the place of that which has been last used. The collector should also be furnished with a number of Bottles, into which he may transfer the samples thus obtained, and none are so convenient as the screw-topped bottles made in all sizes by the York Glass Company. It is well that the bottles should be fitted into cases, to avoid the risk of breakage. When Animacules are being collected, the bottles should not be above two-thirds filled, so that adequate air-space may be left.—Whilst engaged in the search for Microscopic objects, it is desirable for the Collector to possess a means of at once recognizing the forms which he may gather, where this is possible, in order that he may decide whether the 'gathering' is or is not worth preserving; for this purpose either a powerful 'Coddington' or 'Stanhope' lens (§ 24), a Beale's Pocket Microscope (§ 76), or the Travelling Microscope of Messrs. Baker or other opticians (§ 78), will be found most useful, according to the class of objects of which the Collector is in search. The former will answer very well for Zoophytes and the larger Diatomaceæ; but the latter will be needed for Desmidiaceæ, the smaller Diatomaceæ, and Animalcules.

217. The same general method is to be followed in the collection of such *marine* forms of Vegetable and Animal life as inhabit the neighborhood of the shore, and can be reached by the Pond-stick. But there are many which need to be brought up from the bottom by means of the *Dredge*; and many others which swim freely through the waters of the Ocean, and are only to be captured by the *Tow-net*. As the former is part of the ordinary equipment of every Marine Naturalist, whether he concern himself with the Microscope or not, the mode of using it need not be here described; but the use of the latter for the purposes of the Microscopist requires special management. The net should be of fine muslin, firmly sewn to a ring of strong wire about 10 or 12 inches in diameter. This may be either fastened by a pair of strings to the stern of a boat, so as to tow *behind* it, or it may be fixed to a stick so held in the hand as to project from the *side* of the boat. In either case the net should be taken in from time to time, and held up to allow the water it contains to drain through it; and should then be turned inside out and moved about in a bucket of water carried in the boat, so that any minute organisms adhering to it may be washed off before it is again immersed. It is by this simple method that Marine *Animalcules*, the living forms of *Radiolaria*, the smaller *Medusoids* (with their allies, *Beroe* and *Cydippe*), *Noctiluca*, the free-swimming larvæ of *Echinodermata*, some of the most curious of the *Tunicata*, the larvæ of *Mollusca*, *Turbellaria*, and *Annelida*, some curious adult forms of these classes, *Entomostraca*, and the larvæ of higher *Crustacea*, are obtained by the Naturalist; and the great increase in our knowledge of these forms which has been gained within recent years, is mainly due to the assiduous use which has been made of it by qualified observers.—It is important to bear in mind, that, for the collection of all the more delicate of the organisms just named (such, for

instance, as *Echinoderm larvæ*), it is essential that the boat should be rowed so slowly that the net may move *gently* through the water, so as to avoid crushing its soft contents against its sides. Those of firmer structure (such as the *Entomostraca*) on the other hand, may be obtained by the use of a Tow-net attached to the stern of a sailing vessel, or even of a steamer, in much more rapid motion.<sup>1</sup> When this method is employed, it will be found advantageous to make the net of conical form, and to attach to its deepest part a wide-mouthed bottle, which may be prevented from sinking too deeply by suspending it from a cork float: into this bottle many of the minute Animals caught by the net will be carried by the current produced by the motion of the vessel through the water, and they will be thus removed from liability to injury. It will also be useful to attach to the ring an inner net, the cone of which, more obtuse than that of the outer, is cut off at some little distance from the apex; this serves as a kind of valve, to prevent objects once caught from being washed out again. The net is to be drawn in from time to time, and the bottle to be thrust up through the hole in the inner cone; and its contents being transferred to a screw-capped bottle for examination, the net may be again immersed. This form of net, however, is less suitable for the most delicate objects, than the simple *Stick-net* used in the manner just described.—The Microscopist on a visit to the seaside, who prefers a quiet row in tranquil waters to the trouble (and occasional *malaise*) of dredging, will find in the collection of floating Animals by the careful use of the *Stick-net* or *Tow-net* a never-ending source of interesting occupation.

---

<sup>1</sup> In the 'Challenger' Expedition, Tow-nets were almost constantly kept in use, not only at the surface, but at various depths beneath it; being attached to a line which was made to hang vertically in the water by the attachment of heavy weights at its extremity. The collections thus made showed the enormous amount of minute Animal life pervading the upper waters of the Ocean.

## CHAPTER VI.

## MICROSCOPIC FORMS OF VEGETABLE LIFE.—SIMPLER ALGÆ.

218. THOSE who desire to make themselves familiar with Microscopic appearances, and to acquire dexterity in Microscopic manipulation, cannot do better than educate themselves for more difficult inquiries by the study of those humblest types of Vegetation, which present Organic Structure under its most elementary aspect. And such as desire to search out the nature and conditions of Living Action, will find in the study of its simplest manifestations the best clue to the analysis of those intricate and diversified combinations, under which it presents itself in the highest Animal Organisms. For it has now been put beyond question, that the fundamental phenomena of Life are identical in Plants and in Animals; and that the living substance which exhibits them is of a nature essentially the same throughout both Kingdoms. The determination of this general fact, which forms the basis of the Science of BIOLOGY, is the most important result of modern Microscopic inquiry; and the illustration of it will be kept constantly in view, in the exposition now to be given of the chief applications of the Microscope to the study of those minute *Protophytes* (or simplest forms of Plant-life), with whose form and structure, and with whose very existence in many cases, we can only acquaint ourselves by its aid.

219. It was formerly supposed that *living action* could only be exhibited by *organized structure*. But we now know that all the functions of Life may be carried on by minute 'jelly-specks,' in whose apparently homogeneous semi-fluid substance nothing like 'organization' can be detected; and further, that even in the very highest organisms, which present us with the greatest variety of 'differentiated' structures, the essential part of the Life-work is done by the same material—these structures merely furnishing the mechanism (so to speak) through which its wonderful properties exert themselves. Hence this substance,<sup>1</sup> known in Vegetable Physiology as *protoplasm*, but often referred to by Zoologists as *sarcode*, has been appropriately designated by Prof. Huxley "the

<sup>1</sup> Attention was drawn in 1835 by Dujardin (the French Zoologist to whom we owe the transfer of the *Foraminifera* from the highest to the lowest place among Invertebrate Animals), to the fact that the bodies of some of the lowest members of the Animal kingdom consist of a structureless, semi-fluid, contractile substance, to which he gave the name *sarcode* (rudimentary flesh). In 1851, the eminent botanist Von Mohl showed that a similar substance forms the essential constituent of the cells of Plants, and termed it *protoplasm* (primitive plastic or organizable material). And in 1863 it was pointed out by Prof. Max Schultze, who had made a special study of the Rhizopod group, that the 'sarcode' of Animals and the 'protoplasm' of Plants are *identical*.—See his Memoir "Ueber das Protoplasma der Rhizopoden und Pflanzenzellen."



Physical Basis of Life." In its typical state (such as it presents among *Rhizopods*, § 396) it is a semi-fluid, tenacious, glairy substance, resembling—alike in aspect and in composition—the *albumen* (or uncoagulated 'white') of an unboiled egg. But it is fundamentally distinguished from that or any other form of dead matter, by two attributes, which (as being peculiar to living substances) are designated *vital*:—1, its power of increase, by *assimilating* (that is, converting into the likeness of itself, and endowing with its own properties) nutrient material obtained from without; 2, its power of *spontaneous movement*, which shows itself in an extraordinary variety of actions, sometimes slow and progressive, sometimes rapid, sometimes wave-like and continuous, and sometimes rhythmical with regular intervals of rest. When examined under a sufficiently high magnifying power, multitudes of minute granules are usually seen to be diffused through it; but these do not appear to belong to it, their presence being (so to speak) accidental, depending upon the nature of the material which is undergoing assimilation.—Protoplasm, whether living or dead, has a great power of absorbing water; but the distinction between these two states is singularly marked by its behavior in regard to any coloring matter which the water may contain. Thus, if living protoplasm be treated with a solution of carmine, it will remain unstained so long as it retains its vitality. "But if the protoplasm be dead, the carmine will at once pervade its whole substance, and stain it throughout with a color even more intense than that of the solution; thus furnishing (as was first pointed out by Dr. Beale) a ready means of distinguishing the 'germinal matter' or protoplasmic component of the Tissues of higher Animals, from the 'formed material' which is the most conspicuous part of their structure (Chap. XX.)

220. All those minute and simple forms of Life with which the Microscope brings us into acquaintance, essentially consist of particles of protoplasm; each kind having usually a tolerably definite size and shape, and showing (at least in some stage of its existence) something distinctive in its habit of life. And it is rather according to the manner in which they respectively live, grow, and multiply, than on account of any structural peculiarities, that they are assigned to the Vegetable or to the Animal kingdom respectively. It is impossible, in the present state of our knowledge, to lay down any definite line of demarcation between the two Kingdoms; since there is no single character by which the Animal or Vegetable nature of any organism can be tested. Probably the one which is most generally applicable among those that most closely approximate to one another, is not, as formerly supposed, the presence or absence of spontaneous motion; but, on the one hand, the dependence of the organism for nutriment upon *organic compounds already formed*, which it takes (in some way or other) into the interior of its body; or, on the other, its possession of the power of *producing the organic compounds* which it applies to the increase of its fabric, at the expense of the *inorganic elements* with which it is supplied by Air and Water. The former, though perhaps not an *absolute* is a *general* characteristic of the *Animal* kingdom; the latter, but for the existence of which Animal life would be impossible, is certainly the *prominent* attribute of the *Vegetable*. We shall find that the *Protozoa* (or simplest Animals, Chaps. x., XI.) are supported as exclusively either upon other *Protozoa* or upon *Protophytes*, as are the highest Animals upon the flesh of other Animals or upon the products of the Vegetable kingdom; whilst *Protophytes*, in common with the highest Plants, draw *their* nourishment from the



atmosphere or the water in which they live; and, like them, are distinguished by their power of decomposing Carbonic acid ( $\text{CO}^2$ ) under the influence of Light—setting free its Oxygen, and combining its Carbon with the elements of Water to form the Carbo-hydrogen compounds (Starch, Cellulose, etc.), and with those of atmospheric Ammonia to form Nitrogenous (albuminoid) compounds. And we shall find, moreover, that even such *Protozoa* as have neither stomach nor mouth, receive their alimentary matter direct into the very substance of their bodies, in which it undergoes a kind of digestion; whilst *Protophyta* absorb through their external surface only, and take in no solid particles of any description. With regard to *motion*, which was formerly considered the distinctive attribute of Animality, we now know not merely that many Protophytes (perhaps all, at some period or other of their lives) possess a power of spontaneous movement, but also that the instruments of motion (when these can be discovered) are of the very same character in the Plant as in the Animal; being little hair-like filaments, termed *cilia* (from the Latin *cilium*, an eye-lash), or longer whip-like *flagella*, by whose rhythmical vibrations the body of which they form part is propelled in definite directions. The peculiar contractility of these organs seems to be an intensification of that of the general protoplasmic substance, of which they are special extensions.

221. There are certain Plants, however, which resemble Animals in their dependence upon Organic compounds prepared by other organisms; being themselves unable to effect that fixation of Carbon by the decomposition of the  $\text{CO}^2$  of the Atmosphere, which is the first stage in their production. Such is the case, among *Phanerogams* (flowering plants), with the 'leafless parasites' which draw their support from the juices of their 'hosts.' And it is the case also, among the lower *Cryptogams*, with the entire group of FUNGI; which, however, seem generally to depend rather, for their nutritive materials, upon organic matter in a state of decomposition, many of them having the power of promoting that process by their *zymotic* (fermentative) action (Chap. VII.).—Among Animals, again, there are several in whose tissues are found organic compounds, such as Chlorophyll, Starch, and Cellulose, which are characteristically Vegetable; but it has not yet been proved that they *generate* these compounds for themselves, by the decomposition of  $\text{CO}^2$ .

222. The plan of Organization recognizable throughout the Vegetable kingdom presents this remarkable feature of uniformity,—that the fabric, alike in the highest and most complicated Plants, and in the lowest and simplest forms of Vegetation, consists of nothing else than an aggregation of the bodies termed *Cells*; every one of which (save in the forms that lie near the border-ground between Animal and Vegetable life) has its little particle of protoplasm inclosed by a casing of the substance termed *cellulose*—a non-nitrogenous substance nearly allied in chemical composition to starch. The entire mass of cells of which any Vegetable organism is composed, has been generated from one primordial cell by processes of self-multiplication to be presently described: and the difference between the fabrics of the lowest and of the highest Plants essentially consist in this,—that whilst the cells produced by the self-multiplication of the primordial cell of the Protophyte are all mere repetitions of it and of one another, each living *by* and *for* itself—those produced by the like self-multiplication of the primordial cell in the Oak or Palm, not only remain in mutual connection, but undergo a progressive 'differentiation,' the ordinary type of the Cell undergoing vari-

ous modifications to be described in their proper place (Chap. VIII.). A composite structure is thus developed, which is made up of a number of distinct 'organs' (stem, leaves, roots, flowers, etc.); each of them characterized by specialties not merely of external form, but of intimate structure; and each performing actions peculiar to itself, which contribute to the life of the Plant *as a whole*. Hence, as was first definitely stated by Schleiden, it is in the *life history of the individual cell* that we find the true basis of the study of Vegetable Life in general.

223. We have now to consider in more detail the structure and life-history of the typical Plant-cell; and shall begin by treating of the *Cell-wall*.—This consists of two layers, differing entirely in composition and properties. It is the *inner*, termed the 'primordial utricle,' that is first formed, and is most essential to the existence of the cell; it is extremely thin and delicate, so that it escapes attention so long as it remains in contact with the external layer; and it is only brought into view when separated from this, either by developmental changes (Fig. 141, A), or by the influence of reagents which cause it to contract by drawing-forth part of its contents (Fig. 139, c). It is not sharply defined on its internal face, but passes gradationally into the protoplasmic substance it incloses, from which it is chiefly distinguishable by the absence of granules. And it is shown by the effects of re-agents to have the *albuminous* composition of protoplasm. It may thus be regarded as the slightly condensed external film of the protoplasmic layer with which its inner surface is in contact; and as it essentially corresponds with the 'ectosarc' of *Amœba* or any other Rhizopod (§ 396), it may be termed the *ectoplasm*.—The *outer* layer, on the other hand, entirely consists of *cellulose*, which seems to be excreted from the surface of the 'ectoplasm' for the protection of its contents; it is usually thick and strong, and can often be seen to consist of several layers. The 'ectoplasm' and 'cellulose wall' can be readily distinguished from one another by Chemical tests (§ 204); and also by the action of Carmine, which stains the protoplasmic substance (when dead) without affecting the cellulose-wall.

224. The *contents* of the Plant-cell, which may be collectively termed the *endoplasm* (answering to the 'endosarc' of Rhizopods), or, when strongly colored throughout (as in many *Algæ*) the *endochrome*, consists in the first place of the layer of protoplasmic substance which lines the 'ectoplasm;' secondly, of a watery fluid, called 'cell-sap,' which holds in solution sugar, vegetable acids, saline matters, etc.; thirdly, of the peculiar body termed the 'nucleus;' and fourthly, of chlorophyll-corpuscles (inclosing starch-granules), oil-particles, etc.—In the young state of the cell, the whole cavity is occupied by the protoplasmic substance, which is, however, viscid and granular near the cell-wall, but more watery towards the interior. With the enlargement of the cell and the imbibition of water, clear spaces termed *vacuoles*, filled with watery cell-sap, are seen in the protoplasmic substance; and these progressively increase in size and number, until they come to occupy a considerable proportion of the cavity, the protoplasm stretching across it as an irregular network of bands. Where, as usually happens, the 'nucleus' lies imbedded in the outer protoplasmic layers, these bands are gradually withdrawn into it, so that the separate vacuoles unite into one large general vacuole which is filled with watery cell-sap. But where the 'nucleus' occupies the centre of the cell, part of the protoplasm collects around it, and bands or threads of protoplasm stretch thence to various parts of the parietal layer. It is by the contractility of the protoplasmic layer, that the curious 'cy-

closis' hereafter to be described (§ 258) is carried-on within the Plant-cell, which is the most interesting to the Microscopist of all its manifestations of vital activity.—The *nucleus* is a small body, usually of lenticular or sub-globose form (Fig. 139, A, a), and of albuminous composition, that lies imbedded in protoplasmic substance, either on the cell-wall or in the central cavity. It is not, however, constantly present even in the higher forms of cell-structure; for in those cells whose active life has been completed, the nucleus is usually absent, having probably been resolved again into the protoplasm from which it was originally formed. And in the cells of many of the lower Cryptogams, it cannot be distinguished at any stage of their existence. Within the nucleus are often seen one or more small distinct particles termed *nucleoli* (Fig. 139, A, b), which can be best distinguished by the strong coloration they receive from a 24 hours' immersion in carmine, and subsequent washing in water slightly acidulated with acetic acid. Though the precise function of the nucleus is still unknown, there can be no reasonable doubt of its peculiar relation to the vital activity of the cell: for in the nucleated cells which exhibit 'cyclosis,' it may be observed that if the nucleus remains attached to the cell-wall, it constitutes a centre from which the protoplasmic streams diverge, and to which they return; whilst if it retains its freedom to wander about, the course of the streams alters in conformity with its position. But it is in the multiplication of cells by binary subdivision which will be presently described (§ 226), that the speciality of the nucleus as the centre of the vital activity of the cell is most strongly manifested.—The *chlorophyll corpuscles*, which are limited to the cells of the parts of plants acted-on by light, are specialized particles of protoplasm through which a green coloring matter is diffused: and it is by them that the work of decomposing CO<sup>2</sup>, and of 'fixing' its carbon, by union with the oxygen and hydrogen of water, into *starch* (which seems to be the basis of all other vegetable compounds), is effected. The characteristic green of chlorophyll often gives place to other colors, which seem to be produced from it by chemical action.—Starch-grains are always formed in the first instance in the interior of the chlorophyll-corpuscles, and gradually increase in size until they take the places of the corpuscles that produced them. So long as they continue to grow, they are always imbedded in the protoplasm of the cell; and it is only when fully formed, that they lie free within its cavity (Fig. 246).

225. But although these component parts may be made-out without any difficulty in a large proportion of Vegetable Cells, yet they cannot be distinguished in some of those humble organisms which are nearest to the border-line between the two Kingdoms. For in them we find the 'cell-wall' very imperfectly differentiated from the 'cell-contents;' the former not having by any means the firmness of a perfect membrane, and the latter not possessing the liquidity which elsewhere characterizes them. And in some instances the cell appears to be represented only by a mass of endochrome, so viscid as to retain its external form without any limiting membrane, though the superficial layer seems to have a firmer consistence than the interior substance; and this may or may not be surrounded by a gelatinous-looking envelope, which is equally far from possessing a membranous firmness, and yet is the only representative of the cellulose-wall. This viscid endochrome consists, as elsewhere, of a colorless protoplasm, through which minute coloring particles are diffused, sometimes uniformly, sometimes in local aggregations, leaving parts of the protoplasm uncolored. The superficial layer, in particular,

is frequently destitute of color; and the partial solidification of its surface gives it the character of an 'ectoplasm.' The nucleus, as already mentioned, is frequently absent from the cells of the lower *Protophytes*.—It is an extremely curious feature in the cell-life of certain *Protophytes*, that they not only move like *Animalcules* by cilia or flagella, but that they exhibit the rhythmically-contracting vacuoles which are specially characteristic of *Protozoic* organisms.

226. So far as we yet know, every Vegetable Cell derives its existence from a pre-existing cell; and this derivation may take place (in the ordinary process of growth and extension, as distinguished from 'sexual generation') in one of two modes:—either (1) *binary subdivision* of the parent-cell, or (2) *free cell-formation* within the parent-cell.—The first stage of the former process consists in the elongation and transverse constriction of the nucleus; and this constriction becomes deeper and deeper, until the nucleus divides itself into two halves (Fig. 139, B, a, a').

These then separating from each other, the endoplasm of the parent-cell collects round the two new centres, so as to divide itself into two distinct masses (c, a, a'); and by the investment of these two secondary 'endoplasms,' first with 'ectoplasms,' and afterwards with cellulose-walls, a complete pair of new cells (d, a, a') is formed within the cavity of the parent-cell.—The latter process, which is very common among *Protophytes* (being that by which 'zoöspores,' or 'swarm-spores,' are commonly produced, § 245), is chiefly seen among *Phanero-gams* in the production of a number of cells at once within the cavity of the 'embryo-sac' (§ 349), which may itself be considered as a distended parent-cell. The endoplasm, in the former of these cases, instead of dividing itself into two halves, usually breaks up into numerous segments corresponding with one another in size and form (Fig. 149), each of which escaping from the parent

cavity becomes an independent cell, and gives origin by duplicative subdivision to a new fabric. In the second case, the endoplasm groups itself, more or less completely, round several centres, each of which may or may not contain a nucleus in the first instance; and these secondary cells, in various stages of development, lie free within the cavity of the parent-cell, imbedded in its residual endoplasm, each proceeding to complete itself as a cell by the formation of a limiting wall, and by the development of a nucleus if none was previously present (Fig. 140). Now, in this second case, as the new brood of cells continues to form part of the fabric in which it originated, its production is clearly

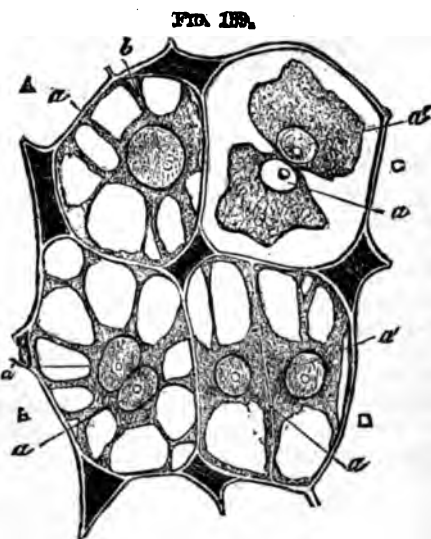
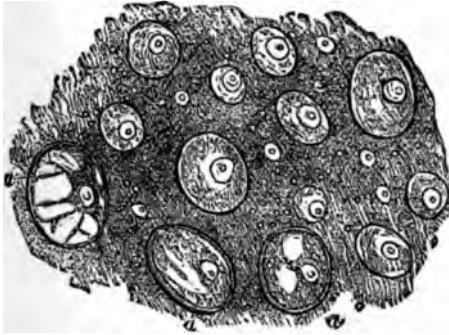

Fig. 139.  
Duplicative Subdivision of Cells in Endosperm of Seed of Scarlet-runner:—A, ordinary cell, with nucleus a, and nucleolus b, imbedded in its protoplasm;—B, cell showing subdivision of nucleus into two halves, a and a';—C, cell in same stage, showing contraction of endoplasm (produced by addition of water), into two separate masses round the two segments of original nucleus;—D, two complete cells within mother-cell, divided by partition.



an act of *growth*; and although, in the first case, the setting-free of the 'swarm-spores' from the parent-cell calls into existence a fresh brood of secondary organisms, this is no more to be regarded in strictness as a 'new generation,' than is the putting-forth of a new set of leaf-buds by a tree—every one of them, when separated from its stock, developing

FIG. 140.



Successive stages of free Cell-formation in Embryo-sac of Seed of Scarlet-runner:—a, a, a, completed cells, each having its proper cell-wall, nucleus, and endoplasm, lying in a protoplasmic mass, through which are dispersed nuclei and cells in various stages of development.

itself under favorable conditions into the likeness of that which produced it. As a 'new generation,' in any *Phanerogamic* plant, has its origin in the fertilization of a highly specialized 'germ-cell' (contained within the ovule) by the contents of a 'sperm-cell' (the pollen-grain) so do we find among all save the lowest *Cryptogams* a provision for the union of the contents of two highly specialized cells; the 'germ-cells' being fertilized by the access of motile filaments (antherozoids), set free from the cavities of the 'sperm-cells' within which they were developed (§ 259). But although the sexual process can be traced downwards under this form

into the group of *Protophytes*, we find among the lower types of that group a yet simpler mode of bringing it about; for there is strong reason to regard the act of 'conjugation,' which takes place among the 'unicellular' *Algae* (§§ 229, 235), in the same light, and to look upon the 'oöspore'<sup>1</sup> which is its immediate product, as the originator (like the fertilized embryo-cell of the *Phanerogamic* seed) of a 'new generation.'

226. In the lowest form of vegetation, every single cell is not only capable of living in a state of isolation from the rest, but even normally does so; and thus the plant may be said to be *unicellular*, every cell having an independent 'individuality.' There are others, again, in which amorphous masses are made up by the aggregation of cells, which, though quite capable of living independently, remain attached to each other by the mutual fusion (so to speak) of their gelatinous investments. And there are others, moreover, in which a definite adhesion exists between the cells, and in which regular plant-like structures are thus formed,

<sup>1</sup> The term *spore* has been long used by *Cryptogamists* to designate the minute reproductive particles (such as those set free from the 'fructification' of Ferns, Mosses, etc.), which were supposed—in the absence of all knowledge of their sexual relations—to be the equivalents of the Seeds of Flowering plants. But it is now known that such 'spores' have (so to speak) very different values in different cases; being, in by far the larger proportion of *Cryptogams*, but the remote descendants of the fertilized cell which is the immediate product of the sexual act under any of its forms. This cell, which will be distinguished throughout the present treatise as the *oöspore*, is the real representative of the 'primordial cell' of the 'embryo' developed within the *seed* of the Flowering plant. On the other hand, the various kinds of *non-sexual* spores emitted by *Cryptogams*, which have received a great variety of designations, are all to be regarded (as will be presently explained) as equivalents of the *leaf-buds* of Flowering plants. (See the next Note.)

notwithstanding that every cell is but a repetition of every other, and is capable of living independently if detached, so as still to answer to the designation of a 'unicellular' or single-celled Plant. These different conditions we shall find to arise out of the mode in which each particular species multiplies by binary subdivision (§ 226): for where the cells of the new pair that is produced within the previous cell undergo a *complete* separation from one another they will henceforth live independently; but, if, instead of undergoing this complete fission, they should be held together by the intervening gelatinous envelope, a shapeless mass results from repeated subdivisions not taking place on any determinate plan; and if, moreover, the binary subdivision should always take place in a determinate direction, a long narrow filament (Fig. 145, D), or a broad flat leaf-like expansion (G), may be generated. To such extended fabrics the term 'unicellular' plants can scarcely be applied with propriety; since they may be built-up of many thousands or millions of distinct cells, which have no disposition to separate from each other spontaneously. Still they correspond with those which are strictly unicellular, as to the *absence of differentiation* either in structure or in actions between their component cells; each one of these being a repetition of the rest, and no relation of mutual dependence existing among them. And all such simple organisms, therefore, may still be included under the general term of PROTOPHYTES.

228. Excluding *Lichens*, for the reasons to be stated hereafter (§ 325), Botanists now rank these Protophytes under two series:—*Algæ*, which form chlorophyll, and can support themselves upon air, water, and mineral matters; and *Fungi*, which, not forming chlorophyll for themselves, depend for their nutriment upon materials drawn from other organisms. Each series contains a large variety of forms, which, when traced from below upwards, present gradationally increasing complexities of structure; and these gradations show themselves especially in the provisions made for the Generative process. Thus, in the lowest, a 'zygospore' is produced by the fusion of the contents of two cells, which neither present any sexual difference, the one from the other, nor can be distinguished in any way from the rest (§ 229). In the following stage, while the 'conjugating' cells are still apparently undifferentiated from the rest of the structure, a sexual difference shows itself between them; the contents of one cell (male) passing over into the cavity of the other (female), within which the 'zygospore' is formed (§ 235). The next stage in the ascent is the resolution of the contents of the male cell into motile filaments ('antheroids'), which, escaping from it, move freely through the water, and find their way to the female cell, whose contents, fertilized by mixture with the material they bring (§ 249), form an 'oöspore.' In the lower forms of this stage, again, the generative cells are not distinguishable from the rest, until the contents begin to show their characteristically sexual aspect (§ 253); but in the higher they are developed in special organs, constituting a true 'fructification' (§ 259). This must, however, be distinguished from organs, which, though commonly spoken of as the 'fructification,' have no real analogy with the generative apparatus of Flowering-plants; their function being merely to give origin to *gonidial* cells or groups of cells, which simply *multiply* the parent stock, in

<sup>1</sup> The term *Gonidia*, originally applied to certain green cells in the Lichen-crusts, that are capable, when detached, of reproducing the vegetative portion of the Plant (§ 325), has latterly come into use as a designation of the *non-sexual spores* of Cryptogamia generally, which it is very important to discriminate from

the same manner that many Flowering-plants (such as the Potato), can be propagated by the artificial separation of their leaf-buds. It frequently happens among Cryptogamia, that this *gonidial* fructification is by far the more conspicuous; the *sexual* fructification being often so obscure that it cannot be detected at all without great difficulty. And we shall presently see that there are some Protophytes in which the production of *gonidia* seems to go on indefinitely, no form of sexual generation having been detected in them (§ 245).—These general statements will now be illustrated by sketches of the Life-history of some of those humble Protophytes, which present the phenomena of cell-division, conjugation, and gonidial multiplication, under their simplest and most instructive aspect.

229. The first of these is the *Palmoglaea macrococca* (Kützing); one of those humble kinds of vegetation which spreads itself as a green slime over damp stones, walls, etc. When this slime is examined with the microscope, it is found to consist of a multitude of green cells (Plate VIII., fig. 1, A), each surrounded by a gelatinous envelope; the cell, which does not seem to have any distinct membranous wall, is filled with a granular 'endochrome' consisting of green particles diffused through colorless protoplasm; and in the midst of this a nucleus may sometimes be distinguished, but can always be brought into view by tincture of iodine, which turns the 'endochrome' cell to a brownish hue, and makes the nucleus (a) dark brown. Other cells are seen (B), which are considerably elongated, some of them beginning to present a sort of hour-glass contraction across the middle; and when cells in this condition are treated with tincture of iodine, the nucleus is seen to be undergoing the like elongation and constriction (H). A more advanced state of the process of subdivision is seen at C, in which the constriction has proceeded to the extent of completely cutting-off the two halves of the cell, as well as of the nucleus (i), from each other, though they still remain in mutual contact; but in a yet later stage they are found detached from each other (D), though still included within the same gelatinous envelope. Each new cell then begins to secrete its own gelatinous envelope, so that by its intervention, the two are usually soon separated from one another (E). Sometimes, however, this is not the case; the process of subdivision being quickly repeated before there is time for the production of the gelatinous envelope, so that a series of cells (F) hanging-on one to another is produced. There appears to be no definite limit to this kind of multiplication; and extensive areas may be quickly covered, in circumstances favorable to the growth of the plant, by the products of the binary subdivision of one primordial cell. This, as already shown (§ 226), is really an act of *growth*, which continues indefinitely so long as moisture is abundant, and the temperature low.—But under the influence of heat and dryness, the process of cell-multiplication gives place to that of 'con-

---

the generative 'oöspores.' If possessed of *motile* powers, they are spoken of as 'zoöspores,' or sometimes (on account of the appearance they present when a number are set free at once) as 'swarm-spores.' In contradistinction to 'motile' gonidia or 'zoöspores,' those which show no movement are often termed *resting* spores or *statospores*; but such may be either sexual oöspores or non-sexual gonidia; the latter, like the former, often 'encysting' themselves in a firm envelope, and remaining dormant within it for long periods of time. Gonidial spores, again, are sometimes distinctively named according to their size; some of them, which consist of numerous cell-particles clustered together, being designated *macro-gonidia*, in contrast to the *micro-gonidia* consisting of single cell-particles, which, when motile, are known as 'zoöspores.'

PLATE VIII.

FIG. 1.

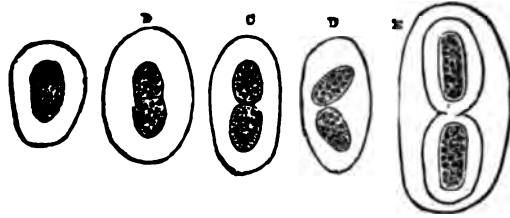
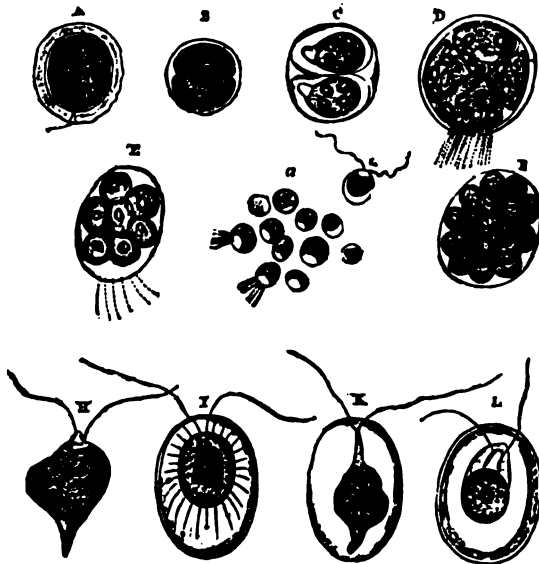

FIG. 2.



DEVELOPMENT OF PALMOGLEA AND PROTOCOCCUS (after Braun and Cohn).

Fig. 1. A—E. Successive stages of binary subdivision of *Palmogloia*; K—M, successive stages of conjugation.

2. A—C. Binary subdivision of 'still' form of *Proctococcus*; D—G, multiplication of 'motile' form; H—L, different phases of 'motile' condition.

*This book is the property of  
COOPER MEDICAL COLLEGE,  
SAN FRANCISCO, CAL.  
and is not to be removed from the  
Library here or by any person or  
under any pretext whatever.*



two cells, apparently similar in all respects, fuse together, the production of a 'zygospore,' which (like the seed of a higher plant) can endure being reduced to a quiescent state for an unlimited period, and may be so completely dried up as to seem like a particle of dust, yet resumes its vegetative activity whenever placed in the conditions favorable to it. The conjugating process commences by the protrusion of protuberances from the boundaries of two adjacent cells, which next fuse together (thereby showing the want of firmness of their cell-walls), and form a connecting bridge between their cavities ( $\kappa$ ). The fusion extends before long through a large part of the contiguous cavities of the two cells ( $\lambda$ ); and at last becomes so complete, that the combined mass ( $\mu$ ) shows no trace of its double origin. It soon forms for itself a thin cellulose envelope, which bursts when the 'zygospore' is released, and the contained cell begins life as a *new generation*, speedily multiplying, like the former ones, by binary subdivision.—It is curious to observe that during this conjugating process a production of oil-particles takes place in the cells; those at first are small and distant, but gradually become larger, and approximate more closely to each other, and at last coalesce so as to form oil-drops of various sizes, the green granular matter disappearing; and the color of the conjugated body changes, white to advance of this process, from green to a light yellowish-brown. When the zygospore begins to vegetate, on the other hand, a converse change occurs; the oil-globules disappear, and green granular matter takes their place. This is precisely what happens in the formation of the seed among the higher Plants; for starchy substances are transformed into oil, which is stored up in the seed for the nutrition of the embryo, and is applied during germination to the purposes which are at other times answered by them.

236. If this (as seems probable) constitutes the entire life-cycle, of the *Protophyte*, it affords no example of that curious 'motile' stage which is exhibited by most Algal protophytes in some stage of their existence, and which constitutes a large part of the life history of the minute unicellular organism now to be described, the *Protopoccus plurialis* (Plate VIII., fig.

The Author had under his own observation, thirty-five years ago, an extraordinary abundance of what he now feels satisfied must have been this Protophyte, in a open rain-water cistern which had been newly cleaned-out. His notice was attracted to it by seeing the surface of the water covered with a green froth, whenever the sun shone upon it. On examining a portion of this froth under the microscope, he found that the water was crowded with green cells in active motion, and although the only bodies at all resembling them of which he could find any description, were the so-called *Animalcules* constituting the genus *Microgaster* of Prof. Ehrenberg, and very little was known at that time of the 'motile' conditions of *Plants* of this description, yet of the Vegetable nature of these bodies he could not entertain the smallest doubt. They appeared in newly collected rain water, and could not, therefore, be deriving their support from organic matter; under the influence of light they were obviously decomposing carbonic acid and liberating Oxygen; and this influence he found to be essential to the continuance of their growth and development, which took place actively upon the Vegetative plan. Not many days after the Protophyte first appeared in the Water, a few Wheel-animalcules presented themselves: these fed voraciously upon it, and increased so rapidly (the weather being very warm) that they speedily became almost as crowded as the cells of the *Protopoccus* had been: and it was probably due in part to their voracity, that the plant soon became less abundant, and before long disappeared altogether. Had the Author been then aware of the assumption of the 'still' condition he might have found it at the bottom of the cistern, after it had ceased to present itself at the surface.—The account of the Plant given above is derived from that of Dr. Cohn, in the "Nova Acta Acad.

2), which is not uncommon in collections of rain-water. Not only has this Protophyte, in its motile-condition, been very commonly regarded as an Animalcule, but its different states have been described under several different names. In the first place, the *color* of its cells varies considerably; since, although they are usually *green* at the period of their most active life, they are sometimes *red*; and their red form has received the distinguishing appellation of *Hæmatococcus*. Very commonly the red-coloring matter forms only a central mass of greater or less size, having the appearance of a nucleus (as shown at E); and sometimes it is reduced to a single granular point, which has been erroneously represented by Prof. Ehrenberg as the *eye* of these so-called Animalcules. It is quite certain that the red coloring-substance is very nearly related in its chemical character to the green, and that the one may be converted into the other: though the conditions under which this conversion takes place are not precisely known. In the *still* form of the cell, with which we may commence the history of its life, the endoplasm consists of a colorless protoplasm, through which red or green-colored granules are more or less uniformly diffused: and the surface of the colorless protoplasm is condensed into an ectoplasm, which is surrounded by a tolerably firm layer, consisting of cellulose or of some modification of it. Outside this (as shown at A), when the 'still' cell is formed by a change in the condition of a cell that has been previously 'motile,' we find another envelope, which seems to be of the same nature, but which is separated by the interposition of aqueous fluid; this, however, may be altogether wanting. The multiplication of the 'still' cells by subdivision takes place as in *Palmoglæa*; the endoplasm first undergoing separation into two halves (as seen at B), and each of these halves subsequently developing a cellulose envelope around itself, and undergoing the same division in its turn. Thus, 2, 4, 8, 16 new cells are successively produced; and these are sometimes set-free by the complete dissolution of the envelope of the original cell; but they are more commonly held together by its transformation into a gelatinous investment, in which they remain imbedded. Sometimes the endoplasm subdivides at once into four segments (as at D), of which every one forthwith acquires the characters of an independent cell; but this, although an ordinary method of multiplication among the 'motile' cells, is comparatively rare in the 'still' condition. Sometimes, again, the endoplasm of the 'still' form subdivides at once into eight portions, which, being of small size, and endowed with motile power, may be considered as *zöospores*. It is not quite clear what becomes of these; but there is reason to believe that some of them retain their motile powers, and develop themselves into the ordinary 'motile' cells; that others produce a firm cellulose envelope, and become 'still' cells; and that others (perhaps the majority) perish without any further change.

231. When the ordinary self-division of the 'still' cells into two segments has been repeated four times, so as to produce 16 cells—and sometimes at an earlier period—the new cells thus produced assume the 'motile' condition; being liberated before the development of the cellulose envelope, and becoming furnished with two long vibratile *flagella*, which seem to be extensions of the colorless protoplasm-layer that accumulates at their base so as to form a sort of transparent beak (H). In this condi-

Nat. Curios." (Bonn, 1850), Tom. xxii.; of which an abstract by Mr. George Busk is contained in the "Botanical and Physiological Memoirs" published by the Ray Society for 1853.

tion it seems obvious that the colorless protoplasm is more developed relatively to the coloring matter, than it is in the 'still' cells; and it usually contains 'vacuoles' occupied only by clear aqueous fluid, which are sometimes so numerous as to take in a large part of the cavity of the cell, so that the colored contents seem only like a deposit on its walls. Before long, this 'motile' cell acquires a peculiar saccular investment, which seems to correspond with the cellulose envelope of the 'still' cells, but is not so firm in its consistence (I, K, L); and between this and the surface of the ectoplasm a considerable space intervenes, traversed by thread-like extensions of the latter, which are rendered more distinct by iodine, and can be made to retract by means of re-agents. The flagella pass through the cellulose envelope, which invests their base with a sort of sheath; and in the portion that is within this sheath no movement is seen. During the active life of the 'motile' cell, the vibration of these flagella is so rapid, that it can be recognized only by the currents it produces in the water through which the cells are quickly propelled; but when the motion becomes slacker, the filaments themselves are readily distinguishable; and they may be made more obvious by the addition of iodine.

232. The multiplication of these 'motile' cells may take place in various modes, giving rise to a great variety of appearances. Sometimes they undergo a regular binary subdivision (B), whereby a pair of motile cells is produced (C), each resembling its single predecessor in possessing the cellulose investment, the transparent beak, and the vibratile filaments, before the dissolution of the original investment. Sometimes, again, the contents of the primordial cell undergo a segmentation in the first instance into four divisions (D); which may either become isolated by the dissolution of their envelope, and may separate from each other in the condition of free primordial utricles (H), developing their cellulose investments at a future time; or may acquire their cellulose investments (as in the preceding case) before the solution of that of the original cell; while sometimes, even after the disappearance of this, and the formation of their own independent investments, they remain attached to each other at their beaked extremities, the primordial utricles being connected with each other by peduncular prolongations, and the whole compound body having the form of a +. This quaternary segmentation appears to be a more frequent mode of multiplication among the 'motile' cells, than the subdivision into two; although, as we have seen, it is less common in the 'still' condition. So, also, a primary segmentation of the entire endochrome of the 'motile' cells into 8, 16, or even 32 parts, may take place (E, F), thus giving rise to as many minute gonidial cells. These *microgonidia*, when set free, and possessing active powers of movement, rank as 'zoospores' (G): they may either develop a loose cellulose investment or cyst, so as to attain the full dimensions of the ordinary motile cells (I, K), or they may become clothed with a dense envelope and lose their flagella, thus passing into the 'still' condition (A); and this last transformation may even take place before they are set free from the envelope within which they were produced, so that they constitute a mulberry-like mass, which fills the whole cavity of the original cell, and is kept in motion by its flagella.

233. These varied forms, whose relation to each other has been clearly proved by watching the successional changes that make up the history of this one Plant, have been described, not merely as distinct *species*, but as distinct *genera* of Animalcules, such as *Chlamydomonas*, *Euglena Trache-*

*lomonas, Gyges, Gonium, Pandorina, Botryocystis, Uvella, Syncrypta, Monas, Astasia, Bodo,* and probably many others. Certain forms, such as the 'motile' cells I, K, L, appear in a given infusion, at first exclusively and then principally; they gradually diminish, become more and more rare, and finally disappear altogether, being replaced by 'still' form. After some time, the number of the 'motile' cells again increases, and reaches, as before, an extraordinary amount; and this alternation may be repeated several times in the course of a few weeks. The process of segmentation is often accomplished with great rapidity. If a number of motile cells be transferred from a larger glass into a smaller, it will be found, after the lapse of a few hours, that most of them have subsided to the bottom; in the course of the day, they will all be observed to be upon the point of subdivision; on the following morning, the divisional brood will have become quite free; and on the next, the bottom of the vessel will be found covered with a new brood of self-dividing cells, which again proceed to the formation of a new brood, and so on.—The activity of Motion and the activity of Multiplication seem to stand, in some degree, in a relation of reciprocity to each other; for the self-dividing process takes place with greater rapidity in the 'still' cells, than it does in the 'motile.'

234. What are the precise conditions which determine the transition between the 'still' and the 'motile' states, cannot yet be precisely stated; but the influence of certain agencies can be predicted with tolerable certainty. Thus it is only necessary to pour the water containing these organisms from a smaller and deeper into a larger and shallower vessel, at once to determine segmentation in numerous cells—a phenomenon which is observable also in many other Protophytes. The 'motile' cells seem to be favorably affected by Light, for they collect themselves at the surface of the water and at the edges of the vessel; but when they are about to undergo segmentation, or to pass into the 'still' condition, they sink to the bottom of the vessel, or retreat to that part of it in which they are least subjected to light. When kept in the dark, the 'motile' cells undergo a great diminution of their chlorophyll, which becomes very pale, and is diffused, instead of forming definite granules; they continue their movement, however, uninterruptedly, without either sinking to the bottom, or passing into the still form, or undergoing segmentation. A moderate warmth, particularly that of the vernal sun, is favorable to the development of the 'motile' cells; but a temperature of excessive elevation prevents it. Rapid evaporation of the water in which the 'motile' forms may be contained, kills them at once; but a more gradual loss, such as takes place in deep glasses, causes them merely to pass into the 'still' form; and in this condition—especially when they have assumed a red hue—they may be completely dried-up, and may remain in a state of dormant vitality for many years. It is in this state that they are wafted-about in atmospheric currents, and that, being brought-down by rain into pools, cisterns, etc., they may present themselves where none had been previously known to exist; and there, under favorable circumstances, they may undergo a very rapid multiplication, and may maintain themselves until the water is dried-up, or some other change occurs which is incompatible with the continuance of their vital activity. They then very commonly become red throughout, the red coloring-substance extending itself from the centre towards the circumference, and assuming an appearance like that of oil-drops; and these red cells, acquiring thick cell-walls and a mucous envelope, float in flocculent aggregations on the



surface of the water. This state seems to correspond with the 'winter-spores' of other Protophytes; and it may continue until warmth, air, and moisture cause the development of the red cells into the ordinary 'still' cells, green matter being gradually produced, until the red substance forms only the central part of the endochrome. After this, the cycle of changes occurs which has been already described; and the Plant may pass through a long series of these, before it returns to the state of the red thick-walled cell, in which it may again remain dormant for an unlimited period.—Even this cycle, however, cannot be regarded as completing the history of the *Protococcus*; since it does not include the performance of any true Generative act. There can be little doubt that, in some stage of its existence, a 'conjugation' of two cells occurs, as in *Palmogloea*; and the attention of observers should be directed to its discovery, as well as to the detection of other varieties in the condition of this interesting little Plant, which will be probably found to present themselves before and after the performance of that act.<sup>1</sup>

235. Nearly related to the foregoing in the independence of their individual cells, are the two groups *Desmidiaceæ* and *Diatomaceæ*, which, in a systematic view, rank as subordinate divisions of the family *Conjugateæ*; their Generative process being performed in the same simple manner as that of *Palmogloea* (§ 229). But these two tribes being of such special interest to the Microscopist as to require separate treatment (§ 260), only that higher group, the *Zygnemaceæ*, will be here noticed, in which the cells produced by binary subdivision remain attached to each other, end to end, so as to form long unbranched filaments (Fig. 141), whose length is continually being increased by a repetition of the same process, which may take place in any part of the filaments, and not at their ends alone. The plants of this group are not found so much in running streams, as in waters that are perfectly still, such as those of ponds, reservoirs, ditches, or marshy grounds; and they are for the most part unattached, floating freely or at near the surface, especially when buoyed-up by the bubbles of gas which are liberated from the midst of them under the influence of solar light and heat. In the early stage of their growth, whilst as yet the cells are undergoing multiplication by subdivision, the endochrome is commonly diffused pretty uniformly through their cavities (Fig. 141, A); but as they advance towards the stage of conjugation, it ordinarily arranges itself into regular spirals (B), though occasionally in some other forms. The act of conjugation usually occurs between the cells of two distinct filaments that happen to lie in proximity to each other; and all the cells of each filament generally take part in it at once. The adjacent cells put forth little protuberances, which come into contact with each other, and then coalesce by the breaking-down of the intervening partitions, so as to establish a free passage between the cavities of the conjugating cells. In some genera of this family (such as *Mesocarpus*), the conjugating cells pour their endochromes into a dilatation of the passage that has been established between them; and it is there that they commingle so as to form the 'zygospore.' But in the *Zygnema* (Fig. 141, B), which is among the commonest and best-known of Conjugateæ, the

<sup>1</sup> In the above sketch, the Author has presented the facts described by Dr. Cohn, under the relation which they seemed to him naturally to bear, but which differs from that in which they will be found in the original Memoir; and he is glad to be able to state, from personal communication with its able Author, that Dr. Cohn's later observations have led him to adopt a view of the relationship of the 'still' and 'motile' forms, which is in essential accordance with his own.

endochrome of one cell passes over entirely into the cavity of the other; and it is within the latter that the 'zygospore' is formed (c), the two endochromes coalescing into a simple mass, around which a firm envelope gradually makes its appearance. Further, it may be generally observed that *all* the cells of one filament thus empty themselves, whilst *all* the cells of the other filament become the recipients: here, therefore, we seem to have a foreshadowing of the sexual distinction of the Generative cells into 'sperm-cells' and 'germ-cells,' which we shall presently see in the filamentous *Confervaceæ*. Multiplication by 'zoospores' has not been seen to take place among the Conjugateæ.

236. From the composite 'motile' forms of *Proctococcus* (§ 232), the transition is easy to the group of *Volvocineæ*—an assemblage of minute Plants of the greatest interest to the Microscopist, on account both of the Animalcule-like activity of their movements, and of the great beauty and regularity of their forms. The most remarkable example of this group is the well-known *Volvox globator* (FRONTSPICER), which is not

FIG. 141.



Various stages of the history of *Zygema quininum*:—A, three cells a, b, c, of a young filament of which b is undergoing subdivision; a, two filaments in the first stage of conjugation, showing the spiral disposition of their endochromes, and the protuberances from the conjugating cells; c, completion of the act of conjugation, the endochromes of the cells of the filament a having entirely passed over to those of filament b, in which the zygospores are formed.

uncommon in fresh-water pools, and which, attaining a diameter of about 1-50th or even 1-30th of an inch, may be seen with the naked eye when the drop containing it is held up to the light, swimming through the water which it inhabits. Its onward motion is usually of a rolling kind; but it sometimes glides smoothly along, without turning on its axis; whilst sometimes, again, it rotates like a top, without changing its position. When examined with a sufficient magnifying power, the *Volvox* is seen to consist of a hollow sphere, composed of a very pellucid material, which is studded at regular intervals with minute green spots, and which is often (but not constantly) traversed by green threads connecting these spots together. From each of the spots proceed two long *flagella*; so that the entire surface is beset with these lashing filaments, to whose combined action its movements are due. Within the external sphere may generally be seen from two to twenty other globes, of a darker color, and of varying sizes; the smaller of these are attached to the inner surface of the investing sphere, and project into its cavity; but the larger lie freely within the cavity, and may often be observed to revolve by the agency of their own *flagella*. After a time, the original sphere bursts,



and the contained spherules swim forth and speedily develop themselves into the likeness of that within which they have been evolved; their colored particles, which are at first closely aggregated together, being separated from each other by the interposition of the transparent pellicle. —It was long supposed that the *Volvox* is a *single* Animal; and it was first shown to be a *compositæ* fabric, made up of a repetition of organisms in all respects similar to each other, by Prof. Ehrenberg; who, however, considered these organisms as *Monads*, and described them as each possessing a mouth, several stomachs, and an eye! Our present knowledge of their nature, however, leaves little doubt of their Vegetable character;<sup>1</sup> and the peculiarity of their history renders it desirable to describe it in some detail.

237. Each of the so-called 'monads' (Plate IX., figs. 9, 11) is a somewhat flask-shaped Plant-cell, about 1-3000th of an inch in diameter; consisting, as in the previous instances, of green chlorophyll-granules diffused through a colorless protoplasm, constituting an 'endochrome' (which commonly includes also a red spot of altered chlorophyll); and bounded by an 'ectoplasm' formed of the condensed and colorless surface-layer of the protoplasmic mass. It is prolonged outwardly (or towards the circumference of the sphere) into a sort of colorless beak or proboscis, from which proceed two *flagella* (fig. 11); and it is invested by a pellucid or hyaline envelope (fig. 9, *d*) of considerable thickness, the borders of which are flattened against those of other similar envelopes (fig. 5, *c, c*), but which does not appear to have the tenacity of a true membrane. —It is impossible not to recognize the precise similarity between the structure of this body, and that of the motile 'encysted' cell of *Protococcus pluvialis* (Plate VIII., fig. 2, *κ*); there is not, in fact, any perceptible difference between them, save that which arises from the regular aggregation, in *Volvox*, of the cells which normally detach themselves from one another in *Protococcus*. The presence of cellulose in the hyaline substance is not indicated, in the ordinary condition of *Volvox globator*, by the iodine and the sulphuric acid test, though the use of 'Schultz's solution' gives to it a faint blue tinge; there can be no doubt of its existence, however, in the hyaline envelope of *Volvox aureus* (§ 240). The flagella and endoplasm, as in the motile forms of *Protococcus*, are tinged of a deep brown by iodine, with the exception of one or two starch-particles in each cell, which are turned blue; and when the contents of the cell are liberated, bluish flocculi, apparently indicative of the presence of cellulose, are brought into view by the action of sulphuric acid and iodine. All these reactions are characteristically *Vegetable* in their nature.—When the cell is approaching maturity, its endoplasm always exhibits one or more 'vacuoles' (fig. 9, *a, a*), of a spherical form, and usually about one-third of its own diameter; and these 'vacuoles' (which are the so-called 'stomachs' of Prof. Ehrenberg) have been observed by Mr. G. Busk to undergo a very curious rhythmical contraction and dilatation at intervals of about 40 seconds; the contraction (which seems to amount to complete obliteration of the cavity of the vacuole) taking place rapidly or suddenly, whilst the dilatation is slow

<sup>1</sup>Prof. Stein, however, in the last-published part of his great work on the Infusoria ("Organismus der Infusionsthier," Abtheilung III., Leipzig, 1878), still ranks the *Volvocineæ* among the Flagellate animalcules, to which they undoubtedly show a remarkable parallelism in *structure*, the chief evidence of their Vegetable nature lying in their *physiological* conformity to undoubted Proto-phytes.

## PLATE IX.

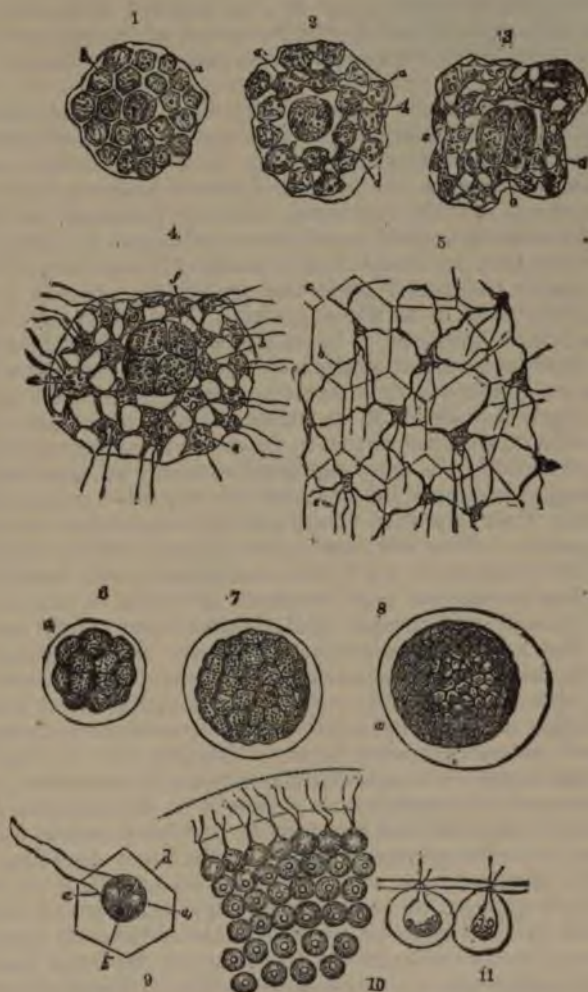

## DEVELOPMENT OF VOLVOX GLOBATOR (after Williamson.)

Fig. 1. Young *Volvox*; *a*, primordial cell of secondary sphere; *b*, polygonal masses of endochrome, separated by hyaline substance.

2. The same more advanced; *a*, *a*, polygonal masses of endochrome; *b*, *b*, their connecting processes; *c*, primordial cell of secondary sphere.

3. The same more advanced, showing an increase in the size of the connecting processes, *a*, *a*, and duplicative subdivision of the primordial cell.

4. The same more advanced, showing the masses of endochrome more widely separated by the interposition of hyaline substance, and each furnished with a pair of flagella; whilst the primordial cell, *f*, has undergone a second segmentation.

5. Portion of the spherical wall of a mature *Volvox*, showing the wide separation of the endochrome-masses still connected by the processes *b*, *b*; the lines of areolation, *c*, dividing the hyaline substance; and the long flagella, *e*.

6, 7, 8. Secondary sphere, or macro-gonidium, developed by the progressive segmentation of the primordial cell.

9. Single cell from the wall of a mature *Volvox*, showing the endochrome mass, *b*, to contain two vacuoles *a*, *a*, and to be surrounded by a hyaline envelope, *d*, having polygonal borders.

10. Portion of the wall of a young *Volvox*, seen edgewise, showing that its sphere is still invested by the hyaline envelope of the original cell, which the flagella penetrate but do not pierce.

11. Two cells from a mature *Volvox*, seen edgewise, showing the inclosure of the endochrome-masses in their own hyaline investment, and the persistence of the general investment (pierced by the flagella) around the entire sphere.



This curious action ceases, however, as the cell arrives at a condition which seems to be marked by the greater extension of the 'ectoplasm,' by the removal or transformation of the chloroplast, and by the formation of the red spot (*b*), which is not observed as in *Protococcus*, of a peculiar modification of chloro-

Each cell normally communicates with the cells in nearest proximity by extensions of its own endochrome, which are sometimes single and sometimes double (fig. 5, *b*, *b'*); and these connecting processes necessarily cross the lines of division between their respective investments. The thickness of these processes varies very considerably;—sometimes they are broad bands, and in other cases mere threads; they are occasionally wanting altogether. This difference seems to depend upon the age of the specimen, and partly upon the abundance of nutriment which it obtains; for, as we shall see, the connection is most intimate at an early period, before the investments of the cells have increased so much as to separate them to a distance from one another (figs. 2, 3, 4); in a mature individual, in which the separation has taken place to a great extent, and the nutritive processes have become less active, the masses of endochrome very commonly assume an angular form, and the connecting processes are drawn-out into threads (as seen in fig. 5), which again their globular form, and the connecting processes altogether disappear. The influence of re-agents, or the infiltration of water into the interior of the hyaline investment, will sometimes cause the connecting process (as in *Protococcus*, § 231) to be drawn back into a central mass of endochrome; and they will also retreat on the mere application of the hyaline investment: from these circumstances it may be inferred that they are not inclosed in any definite membrane. On the other hand, the connecting threads are sometimes seen as double lines, which seem like tubular prolongations of a consistent membrane, without protoplasmic granules in their interior. It is obvious, then, that an examination of a considerable number of specimens, exhibiting various phases of conformation, is necessary to demonstrate the nature of these communications; but this may be best made-out by attending to the history of their development, which we shall now describe.

230. The spherical body of the young *Volvox* (Plate IX., fig. 1) is composed of an aggregation of somewhat angular masses of endochrome separated by the interposition of hyaline substance; and the whole seems to be inclosed in a distinctly membranous envelope, which is probably the distended hyaline investment of the 'primordial' cell, within which, as will presently appear, the entire aggregation originated. In the midst of the polygonal masses of endochrome, one mass (*a*), rather larger than the rest, is seen to present a circular form; and this, as will presently appear, is the originating cell of what is hereafter to become a new sphere. The growing *Volvox* at first increases in size, not only by the interposition of new hyaline substance between its component masses of endochrome, but also by an increase in these masses themselves (fig. 2, *a*), which come into continuous connection with each other by the coa-

<sup>1</sup>The existence of rhythmically contracting vacuoles in *Volvox* (though denied by the observations of Prof. Stein) is denied by Mr. Saville Kent ("Manual of the Infusoria," p. 47); but it may be fairly presumed that he has not looked for them at the stage of development at which their action was witnessed by Mr. Huxley.

lescence of processes (*b*) which they severally put-forth; at the same time an increase is observed in the size of the globular cell (*c*), which is preliminary to its binary subdivision. A more advanced stage of the same developmental process is seen in fig. 3; in which the connecting processes (*a, a*) are so much increased in size, as to establish a most intimate union between the masses of endochrome, although the increase of the intervening hyaline substance carries these masses apart from one another; whilst the endochrome of the central globular cell has undergone segmentation into two halves. In the stage represented in fig. 4, the masses of endochrome have been still more widely separated by the interposition of hyaline substance; each has become furnished with its pair of flagella; and the globular cell has undergone a second segmentation. Finally, in fig. 5, which represents a portion of the spherical wall of a mature *Volvox*, the endochrome-masses are observed to present a more scattered aspect, partly on account of their own reduction in size, and partly through the interposition of a greatly-increased amount of hyaline substance, which is secreted from the surface of each mass; and that portion which belongs to each cell, standing to the endochrome-mass in the relation of the cellulose coat of an ordinary cell to its ectoplasm, is frequently seen to be marked-out from the rest by delicate lines of hexagonal areolation (*e, e*) which indicate the boundaries of each. Of these it is often difficult to obtain a sight, a nice arrangement of the light being usually requisite with fresh specimens; but the prolonged action of water (especially when it contains a trace of iodine), or of glycerine, will often bring them into clear view. The prolonged action of glycerine, moreover, will often show that the boundary lines are double, being formed by the coalescence of two contiguous cell-walls; and they sometimes retreat from each other so far that the hexagonal areolæ become rounded. As the primary sphere approaches maturity, the large secondary germ-mass, or *macro-gonidium*, whose origin has been traced from the beginning, also advances in development; its contents undergoing multiplication by successive segmentations, so that we find it to consist of 8, 16, 32, 64, and still more numerous divisions, as shown in figs. 6, 7, 8. Up to this stage, at which first the sphere appears to become hollow, it is retained within the hyaline envelope of the cell within which it has been produced; a similar envelope can be easily distinguished, as shown in fig. 10, just when the segmentation has been completed, and at that stage the flagella pass into it, but do not extend beyond it; and even in the mature *Volvox* it continues to form an investment around the hyaline envelopes of the separate cells, as shown in fig. 11. It seems to be by the adhesion of the hyaline investment of the new sphere to that of the old, that the secondary sphere remains for a time attached to the interior wall of the primary; at what exact period, or in what precise manner, the separation between the two takes place, has not yet been determined. At the time of the separation, the developmental process has generally advanced as far as the stage represented in fig. 1; the foundation of one or more tertiary spheres being usually distinguishable in the enlargement of certain of its cells.

240. The development and setting-free of these composite 'macro-gonidia,' which is essentially a process of cell-subdivision or *gemmiparous extension* (§ 226), is the ordinary mode of multiplication in *Volvox*; taking place at all times of the year, except when the *sexual generation* (now to be described) is in progress. The mode in which this process is here performed (for our knowledge of which we are indebted to the per-



severing investigation of Prof. Cohn<sup>1</sup>) shows a great advance upon the simple 'conjugation' of two similar cells (§ 229), and closely resembles that which prevails not only among the higher *Algæ*, but (under some form or other) through a large part of the Cryptogamic series. As autumn advances, the *Volvox*-spheres usually cease to multiply themselves by the formation of 'macro-gonidia;' and certain of their ordinary cells begin to undergo changes by which they are converted, some into male or 'sperm-cells,' others into female or 'germ-cells,'—the greater number, however, remaining 'sterile.' Each sphere of *Volvox globator* (FRONTISPIECE, fig. 1) contains both kinds of sexual cells, so that this species ranks as *monœcious*; but *V. aureus* is *diœcious*, the 'sperm-cells' and 'germ-cells' occurring in separate spheres. Both kinds of 'sexual' cells are at first distinguishable from the ordinary 'sterile' cells by their larger size (fig. 2, *a*), in this respect resembling 'macro-gonidia' in an early stage; but their subsequent history is altogether different. The 'sperm-cells' begin to undergo subdivision when they attain about three times the size of the 'sterile' cells; this, however, takes place not on the 'binary' plan, but in such a manner that the endochrome of the primary cell resolves itself into a cluster of very peculiar secondary cells (fig. 1, *a*, *a'*, fig. 5), each consisting of an elongated 'body' containing an orange-colored endochrome with a red corpuscle, and of a long colorless beak, from the base of which proceeds a pair of long flagella (figs. 6, 7),—as in the 'antherozoids' of the higher Cryptogams (Fig. 154, II). As the sperm-cells approach maturity, the aggregate clusters may be seen to move within them, at first slowly, and afterwards more rapidly; the bundles then separate into their component 'antherozoids,' which show an active independent movement whilst still within the cavity of the primary cell (fig. 1, *a'*); and finally escape by the giving-way of its wall (*a''*), diffusing themselves through the cavity of the *Volvox*-sphere. The *germ*-cells (fig. 1, *b*, *b'*), on the other hand, continue to increase in size without undergoing subdivision; at first showing large vacuoles in their protoplasm (*b''*, *b'''*), but subsequently becoming filled with dark-green endochrome. The form of the 'germ-cell' gradually changes from its original flask-shape to the globular (*b''''*); and it projects into the cavity of the *Volvox*-sphere, at the same time acquiring a gelatinous envelope. Over this the swarming antherozoids diffuse themselves (fig. 3), penetrating its substance, so as to find their way to the interior; and in this situation they seem to dissolve-away, so as to become incorporated with the endochrome. The product of this fusion (which is only 'con-

<sup>1</sup> The original observations of Cohn on the sexuality of *Volvox*, published in the "Ann. des Sci. Nat.," 4ième Sér., Botan., Tom. v. (1857), p. 323, were confirmed by Mr. Carter, "Ann. Nat. Hist.," 3d Ser., Vol. iii. (1859), p. 4, who observed the sexual process in *Eudorina* also.—In the well-known form *Pandorina morum*, the generative process is performed, according to the observations of Pringsheim, in a manner curiously intermediate between the lower and the higher types referred to above. For within each cell of the original sixteen of which its mulberry-like mass is composed, a brood of sixteen secondary cells is formed by ordinary binary subdivision; and these, when set free by the dissolution of their containing cell-wall, swim forth as 'swarm-spores,' each being furnished with a pair of flagella. Among the crowd of these swarm-spores may be observed some which approach in pairs, as if seeking one another; when they meet, their points at first come together, but gradually their whole bodies coalesce; and a globular 'zygospore' is thus formed, which germinates after a period of rest, reproducing by binary subdivision the original sixteen-celled mulberry-like *Pandorina*. (See Sachs' "Botany," p. 219.)



jugation' under another form) is a reproductive globule or *oö-spore*; which speedily becomes enveloped by an internal smooth membrane, and with a thicker external coat which is usually beset with conical-pointed processes (fig. 4); and the contained chlorophyll gives place, as in *Pal-mogloea* (§ 229), to starch and a red or orange-colored oil. As many as forty of such 'oö-spores' have been seen by Dr. Cohn in a single sphere of *Volvox*, which thus acquires the peculiar appearance that has been distinguished by Ehrenberg by a different specific name, *Volvox stellatus*. Soon after the 'oö-spores' reach maturity, the parent-sphere breaks up, and the oö-spores fall to the bottom, where they remain during the winter. Their further history has since been traced out by Kirchner; who found that their germination commenced in February with the liberation of the spherical 'endospore' from its envelope, and with its division into four cells by the formation of two partitions at right angles to one another. These partially separate, holding together only at one end, which becomes one pole of the globular cluster subsequently formed by cell-multiplication; the other pole only closing-in when a large number of cells have been formed. The cells are then carried apart from one another by the hyaline investment formed by each; and the characteristic *Volvox*-sphere is thus completed.<sup>1</sup>

241. There are other points in the life-history of *Volvox* which must not be left without mention, although their precise import is as yet uncertain. Thus, according to Mr. G. Busk (with whom Prof. Cohn is in accord on this point), the body designated by Prof. Ehrenberg *Sphærosira volvox* is an ordinary *Volvox* in a different phase of development; its only marked feature of dissimilarity being that a large proportion of the green cells, instead of being single (as in the ordinary form of *Volvox*), save where they are developing themselves into young spheres, are very commonly double, quadruple, or multiple; and the groups of ciliated cells thus produced, instead of constituting a hollow sphere, form by their aggregation discoid bodies, of which the separate fusiform cells are connected at one end, whilst at the other they are free, each being furnished with a single flagellum. These clusters separate themselves from the primary sphere, and swim forth freely, under the forms which have

<sup>1</sup> The doctrine of the *vegetable* nature of *Volvox*, which has been suggested by Siebold, Braun, and other German Naturalists, was first distinctly enunciated by Prof. Williamson, on the basis of the history of its development, in the "Transactions of the Philosophical Society of Manchester," Vol. ix. Subsequently Mr. G. Busk, whilst adducing additional evidence of the Vegetable nature of *Volvox*, in his extremely valuable Memoir in the "Transactions of the Microscopical Society," N. S., Vol. i. (1853), p. 31, called in question some of the views of Prof. Williamson, which were justified by that gentleman in his "Further Elucidations" in the same "Transactions." The description above given by the Author, on the basis of the facts in which these excellent observers were agreed (their original differences having been in great degree reconciled by their mutual admissions), is in entire harmony with the most recent account of this most interesting organism given by Prof. Cohn ("Beiträge zur Biologie der Pflanzen," Bd. i., Heft 3, 1875), to whom we owe the discovery of its generative process. The observations of Dr. Kirchner on its germination will be found in Bd. iii., Heft 1 (1879), of the same serial.—An extremely interesting *Volvocine* form described by Cohn under the name *Stephanosphaera pluvialis* exhibits all the phenomena of reproduction by *macro-gonidia* or composite masses of adherent cells, by *micro-gonidia* or active zoöspores, by 'still' or *stato-spores*, and by *oö-spores* produced by true sexual action, in a very characteristic manner; and his account of its life-history should be consulted by every one who desires to study that of any of the Protophyta. See "Ann. of Nat. Hist.," 2d Ser., Vol. x. (1852), pp. 321, 401, and "Quart. Journ. of Microsc. Sci.," Vol. vi. (1858), p. 131.



been designated by Prof. Ehrenberg as *Uvella* and *Syncrypta*.—Again, it has been noticed by Dr. Hicks' that towards the end of the autumn, the bodies formed by the binary subdivision of the single cells of *Volvox*, instead of forming spherical flagellated 'macro-gonidia' which tend to escape outwards, form clusters of irregular shape, each composed of an indefinite mass of gelatinous substance in which the green cells lie separately imbedded. These clusters, being without motion, may be termed *stato-spores*; and it is probable that they constitute one of the forms in which the existence of this organism is prolonged through the winter.

243. Another phenomenon of a very remarkable nature, namely, the conversion of the contents of an ordinary Vegetable cell into a free moving mass of protoplasm that bears a strong resemblance to the animal *Amœba* (Fig. 289), is affirmed by Dr. Hicks' to take place in *Volvox*, under circumstances that leave no reasonable ground for that doubt of its reality which has been raised in regard to the accounts of similar phenomena occurring elsewhere. The endochrome-mass of one of the ordinary cells increases to nearly double its usual size; but instead of undergoing duplicative subdivision so as to produce a 'macro-gonidium,' as in Fig. 142, *b*, it loses its color and its regularity of form, and becomes an irregular mass of colorless protoplasm, containing a number of brown or reddish-brown granules (*a, a*), and capable of altering its form by protruding or retracting any portion of its membranous wall, exactly like a true *Amœba*. By this self-moving power, each of these bodies, *c, c* (of which twenty may sometimes be counted within a single *Volvox*) glides independently over the inner surface of the sphere among

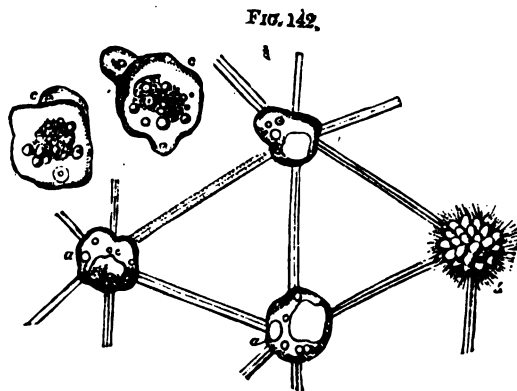

Formation of Amœboid bodies in *Volvox*:—*a, a*, ordinary cells passing into the amœboid condition; *b*, ordinary macro-gonidium; *c, c*, free amœboids.

its unchanged green cells, bending itself round any one of these with which it may come into contact, precisely after the manner of an *Amœba*. After the 'amœboid' has begun to travel, it is always noticed that for every such moving body in the *Volvox* there is the empty space of a missing cell; and this confirms the belief—founded on observation of the gradational transition from the one condition to the other, and on the difficulty of supposing that any such bodies could have entered the sphere parasitically from without—that the 'amœboid' is really the product of the metamorphosis of a mass of Vegetable protoplasm. This metamorphosis may take place, according to Dr. Hicks, even after the process of binary subdivision has commenced. What is the subsequent destination of these Amœboid bodies, has not yet been ascertained.'

<sup>1</sup> "Quart. Journ. of Microsc. Science," N.S., Vol. i. (1861), p. 281.

<sup>2</sup> "Trans. of Microsc. Society, N.S., Vol. viii. (1860), p. 99, and "Quart. Journ. of Microsc. Science," N.S., Vol. ii. (1862), p. 96.

<sup>3</sup> A similar production of 'amœboids' has been observed by Mr. Archer in

243. With the two Protophytes just described may be ranked under the general designation *Palmellaceæ* a number of others scarcely less simple in their essential characters, but sometimes attaining considerable dimensions. They all grow either on damp surfaces, or in fresh or salt water; and they may either form (1) a mere powdery layer, of which the component particles have little or no adhesion to each other, or they may present themselves (2) in the condition of an indefinite slimy film, or (3) in that of a tolerably firm and definitely bounded membranous 'frond.'—The first of these states we have seen to be characteristic of *Palmogloea* and *Proctococcus*; the new cells, which are originated by the process of binary subdivision, usually separating from each other after a short time; and, even where they remain in cohesion, not forming a 'frond' or membranous expansion. The 'red snow,' which sometimes colors extensive tracts in Arctic or Alpine regions, penetrating even to the depth of several feet, and vegetating actively at a temperature which

reduces most plants to a state of torpor, is generally considered to be a species of *Proctococcus*; but as its cells are connected by a tolerably firm gelatinous investment, it would rather seem to be a *Palmella*.—The second is the condition of the *Palmella* proper; of which one species, the *P. cruenta*, usually known under the name of 'gory dew,' is common on damp walls and in shady places, sometimes extending itself over a considerable area as a tough gelatinous mass, of the color and general appearance of coagulated blood. A characteristic illustration of it is also afforded by the *Hæmatococcus sanguineus* (Fig. 143), which chiefly differs from



*Hæmatococcus sanguineus* in various stages of development:—*a*, single cells, inclosed in their mucous envelope; *b*, *c*, cluster formed by subdivision of parent-cell; *d*, more numerous cluster, its component cells in various stages of division; *e*, large mass of young cells, formed by the subdivision of the parent endochrome, and inclosed within a common mucous envelope.

*Palmella* in the partial persistence of the walls of the parent-cells, so that the whole mass is subdivided by partitions, which inclose a larger or smaller number of cells originating in the subdivision of their contents. Besides increasing in the ordinary mode of binary multiplication, the *Palmella*-cells seem occasionally to rupture and diffuse their granular contents through the gelatinous stratum, and thus to give origin to a whole cluster at once, as seen at *e*, after the manner of other simple Plants to be presently described (§ 245), save that these minute segments of the endochrome, having no power of spontaneous motion, cannot be ranked as zoöspores.' The gelatinous masses of the *Palmellæ* are frequently found to contain parasitic growths formed by the extension of other plants through their substance; but numerous branched filaments sometimes present themselves, which, being traceable into absolute con-

*Stephanosphaera pluvialis*; and is scarce!y now to be considered an exceptional phenomenon.

cells, must be considered as properly pertaining to these filaments radiate in various directions from a point, and must at first be considered as mere extensions of the filaments, however, into new cells; and when these are connected by tubular connections close in, and the cells become more or less spherical. Of the *third* condition, we have an example in the *Ulothrix* described by Kützinger; the frond of which is viewed eye like a delicate network consisting of anastomosing filaments composed of a single or double row of large vesicles. The *Ulothrix* which is produced a pair of elliptical vesicles that are called 'zoospores.' The alternation between the 'motile' and the 'resting' form, which has been described as occurring in the *Ulothrix* (§ 211), has been observed in several other forms of the group, and it seems obviously intended, like the production of zoospores, to cause the dispersion of the plant, and to prevent it from being confined to any one locality.—It is very commonly observed in the group, that the Aagal portions of *Lichens* are formed

of a single cell, notwithstanding the very definite form and large size attained by the fronds, which are mostly expansions of the *Ulothrix*, to which group belong the *Ulothrix* 'Sea woods' (or 'flavens') found on every coast, yet their mode of development differs but very little from that of the preceding group, and the principal advance is shown in this, that the cells, when multiplied by binary subdivision, not only remain in firm connection with each other, but possess a very regular arrangement (in virtue of the conditions upon which the subdivision takes place), and form a definite membranous expansion. The mode in which this frond is produced may be best understood by studying the history of its development, some of the principal phases of which are seen in Fig. 144: for the initial cells (A), in which it originates, resembling in all points those of *Ulothrix*, give rise by their successive subdivisions in determinate directions, to such regular clusters as those seen at B and C, or to such simple filaments as that shown at D. A continuation of the same regular mode of subdivision, taking place alternately in two directions, may at once extend the clusters B and C into leaf-like expansions; or, if the filamentous stage be passed through (different species presenting variations in the history of their development), the filament increases in breadth as well as in length (as seen at E), and finally becomes such a frond as is shown at F, G. In the simple membranous expansion, or *Ulothrix*, thus formed, there is no approach to a differentiation of parts by even the semblance of a formation of root, stem, and leaf, such as the higher Algae present; every portion is the exact counterpart of every other, and every portion seems to take an equal share in the operations of growth and reproduction. Each cell is very commonly found to exhibit an imperfect partitioning into four parts, preparatory to multiplication by double subdivision; and the entire frond usually shows the groups of cells arranged in clusters containing some multiple of four.

34. Besides this continuous increase of the individual frond, however, we find in most species of *Ulothrix* a provision for extending the plant by the dispersion of 'zoospores;' for the endochrome (Fig. 145, a) sub-

<sup>1</sup> This fact, first made public by Mr. Thwaites ("Ann. of Nat. Hist.," 2d Series, Vol. II., 1848, p. 313), is one of fundamental importance in the determination of the real character of this group.



divides into numerous segments (as at *b* and *c*), which at first are seen to lie in close contact within the cell that contains them, then begin to exhibit a kind of restless motion, and at last pass forth through an aperture in the cell-wall, acquire four or more flagella (*d*), and swim freely through the water for some time. At last, however, they come to res attach themselves to some fixed point, and begin to grow into clusters or filaments (*e*), in the manner already described. The walls of the cells which have thus discharged their endochrome, remain as colorless spots on the frond; sometimes these are intermingled with the portions still vegetating in the usual mode; but sometimes the whole endochrome of one portion of the frond may thus escape in the form of zoospores, thus leaving behind it nothing but a white flaccid membrane. If the Microscopist who meets with a frond of an *Ulva* in this condition should examine the line of separation between its green and its colored portions, he may not improbably meet with cells in the very act of discharging their zoospores, which 'swarm' around their points of exit very much in the manner that Animalcules are often seen to do around particular spots of the-field of view, and which might easily be taken for true Infusoria; but on carrying his observations further, he would see that similar bodies are moving *within* cells a little more remote from the dividing line, and that, a little farther still, they are obviously but masses of endochrome in the act of subdivision.<sup>1</sup>—Of the true Generative process in the *Ulvaceæ*, nothing whatever is known.



Successive stages of development of *Ulva*.

246. The *Oscillatoriaceæ* constitute another tribe of Protophytes of great interest to the Microscopist, on account both of the extreme simplicity of their structure, and of the peculiar Animal-like movements which they exhibit. They are continuous tubular filaments, formed by the elongation of their primordial cells, usually lying together in bundles or in strata, sometimes quite free, and sometimes invested by gelatinous sheaths. The cellulose envelope (Fig. 146, A, *a, a*) usually exhibits some degree of transverse striation, as if the tube were undergoing division into cells; but this division is never perfected by the formation of complete partitions, though the endochrome shows a disposition to separate into regular segments (B, *c*), especially when treated with re-agents.

<sup>1</sup> Such an observation the Author had the good fortune to make in the year 1842, when the emission of zoospores from the *Ulvaceæ*, although it had been described by the Swedish Algologist Agardh had not been seen (he believes) by any British naturalist.



According to Dr. F. d'Alquen,<sup>1</sup> each filament—at least in certain species—has an axis of different composition from the surrounding endochrome; being solid, highly refractive, but slightly affected by iodine, and nearly colorless when moist, though slightly greenish when dry. And he gives reasons for the belief that it is in this (protoplasmic?) axis that the peculiar motor power of the filament specially, if not exclusively, resides. The filaments ultimately break up into distinct joints; the fragments of endochrome, which are to be regarded as *gonidia*, usually escaping from their sheaths, and giving origin to new filaments.—These plants are commonly of some shade of green, often mingled, however, with blue; but not unfrequently they are of a purplish hue, and are sometimes so dark as when in mass to seem nearly black. They occur not only in fresh, stagnant, brackish, and salt waters (certain species being peculiar to each), but also in mud, on wet stones, or on damp ground. Their movements are described by Dr. Harvey<sup>2</sup> as of three kinds; first, a pen-

FIG. 145.

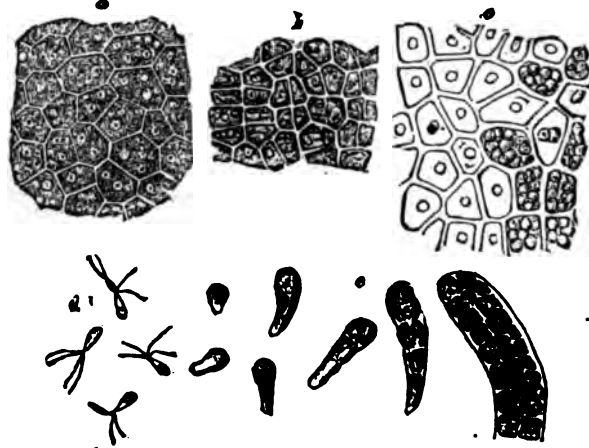

Formation of Zoospores in *Phycoseris gigantea* (*Ulva latissima*):—a, portion of the ordinary frond; b, cells in which the endochrome is beginning to break up into segments; c, cells from the boundary between the colored and colorless portions, some of them containing zoospores, others being empty; d, flagellated zoospores, as in active motion; e, subsequent development of the zoospores.

dulum-like movement from side to side, performed by one end, whilst the other remains fixed so as to form a sort of pivot; second, a movement of flexure of the filament itself, the oscillating extremity bending over, first to one side and then to the other, like the head of a worm or caterpillar seeking something on its line of march; and third, a simple onward movement of progression. "The whole phenomenon," continues Dr. H., "may perhaps be resolved into a spiral onward movement of the filament. If a piece of the stratum of an *Oscillatoria* be placed in a vessel of water, and allowed to remain there for some hours, its edge will first become fringed with filaments, radiating as from a central point, with their tips outwards. These filaments, by their constant oscillatory movements, are continually loosened from their hold on the stratum, cast into the water,

<sup>1</sup> "Quart. Journ. of Microsc. Science," Vol. iv. (1856), p. 245.

<sup>2</sup> "Manual of British Marine Algæ," p. 220.

and at the same time propelled forward; and as the oscillation continues after the filament has left its nest, the little swimmer gradually moves along, till it not only reaches the edge of the vessel, but often—as if in the attempt to escape confinement—continues its voyage up the sides, till it is stopped by dryness. Thus in a very short time a small piece of *Oscillatoria* will spread itself over a large vessel of water." This rhythmical movement, impelling the filaments in an undeviating onward course, is greatly influenced by temperature and light, being much more active in warmth and sunshine than in cold and shade; and it is checked by any strong chemical agents.—The true Generation of *Oscillatoriaceæ* is as yet completely unknown.

247. Nearly allied to the preceding is the little tribe of *Nostochaceæ*; which consists of distinctly-beaded filaments, lying in firmly-gelatinous fronds of definite outline (Fig. 147). The filaments are usually simple,

FIG. 146.



Structure of *Oscillatoria contexta*.—A, portion of a filament, showing the striations on the cellulose-coat, a, where the endochrome is wanting; B, portion of filament treated with weak syrup, showing a disposition to a regular breaking-up of the endochrome into masses; C, portion of filaments treated with strong solution of chloride of calcium, showing a more advanced stage of the same separation.

FIG. 147.



Portion of gelatinous frond of *Nostoc*.

though sometimes branched; and are almost always curved or twisted, often taking a spiral direction. The masses of jelly in which they are imbedded are sometimes globular or nearly so, and sometimes extend in more or less regular branches; they frequently attain a very considerable size; and as they occasionally present themselves quite suddenly (especially in the latter part of autumn, on damp garden-walks), they have received the name of 'fallen stars.' They are not always so suddenly produced, however, as they appear to be; for they shrink up into mere films in dry weather, and expand again with the first shower.<sup>1</sup> Nostocs multiply, like the *Oscillatoriaceæ*, by the subdivision of their filaments, portions of which escape from the gelatinous mass wherein they were imbedded, and move slowly through the water in the direction of their length: after a time they cease to move, and a new gelatinous envelope is formed around each piece, which then begins not only to increase in length by the transverse subdivision of its segments, but also to double

<sup>1</sup> See Hicks in "Quart. Journ. of Microsc. Science.," N.S., Vol. i. (1861), p. 90.

itself by longitudinal fission, so that each filament splits lengthways (as it were) into two new ones. By the repetition of this process a mass of new filaments is produced, the parts of which are at first confused, but afterwards become more distinctly separated by the interposition of the gelatinous substance developed between them.—Besides the ordinary cells of the beaded filaments, two other kinds are occasionally observable; but it has not yet been ascertained whether these are in any way subservient to the true Generative act.

248. Although many of the plants belonging to the Family *Siphonaceæ* attain a considerable size, and resemble the higher Sea weeds in their general mode of growth, yet they retain a simplicity of structure so extreme that it apparently requires them to be ranked among the Proto-phytes. They are inhabitants both of fresh-water and of the sea; and consist of very large tubular cells, which commonly extend themselves into branches, so as to form an aborescent frond. These branches, however, are seldom separated from the stem by any intervening partition; but the whole frond is composed of a simple continuous tube, the entire contents of which may be readily pressed-out through an orifice made by wounding any part of the wall. The *Vaucheria*, named after the Genevese botanist by whom the fresh-water *Confervæ* were first carefully studied, may be selected as a particularly good illustration of this family; its history having been pretty completely made out. Most of its species are inhabitants of fresh water; but some are marine; and they commonly present themselves in the form of cushion-like masses, composed of irregularly branching filaments, which, although they remain distinct, are densely tufted together and variously interwoven.—The formation of motile *gonidia* or 'zoöspores' may be readily observed in these plants, the whole process usually occupying but a very short time. The extremity of one of the filaments usually swells up in the form of a club, and the endochrome accumulates in it so as to give it a darker hue than the rest; a separation of this part from the remainder of the filament, by the interposition of a transparent space, is next seen; a new envelope is then formed around the mass thus cut off; and at last the membranous wall of the investing tube gives way, and the 'zoöspore' escapes, not, however, until it has undergone marked changes of form, and exhibited curious movements. Its motions continue for some time after its escape, and are then plainly seen to be due to the action of the *cilia* with which its whole surface is clothed. If it be placed in water in which some carmine or indigo has been rubbed, the colored granules are seen to be driven in such a manner as to show that a powerful current is produced by their propulsive action, and a long track is left behind it. When it meets with an obstacle, the ciliary action not being arrested, the zoöspore is flattened against the object; and it may thus be compressed, even to the extent of causing its endochrome to be discharged. The *cilia* are best seen when their movements have been retarded or entirely arrested by means of opium, iodine, or other chemical re-agents. The motion of the spore continues for about two hours; but after the lapse of that time it soon comes to an end, and the spore begins to develop itself into a new plant. It has been observed by Unger, that the escape of the zoöspores generally takes place towards 8 A.M.; to watch this phenomenon, therefore, the plant should be gathered the day before, and its tufts examined early in the morning. It is stated by Dr. Hassall, that he has seen the same filament give off two or three zoöspores successively.

249. Recent discoveries have shown that there exists in this humble



plant a true process of sexual Generation, as was, indeed, long ago suspected by Vaucher, though upon no sufficient grounds. The branching filaments are often seen to bear at their sides peculiar globular or oval capsular protuberances, sometimes separated by the interposition of a stalk, which are filled with dark endochrome; and these give exit to large bodies covered with a firm envelope, from which, after a time, new plants arise. In the immediate neighborhood of these 'capsules' are always found certain other projections, which, from being usually pointed and somewhat curved, have been named 'horns' (Fig. 148, A, a); and these have been shown by Pringsheim to be 'antheridia,' which produce, 'antherozoids' in their interior; whilst the capsules (A, b) are 'oögonia,' each containing a mass of endochrome which constitutes a 'germ-cell' that is destined to become, when fertilized, the primordial cell of a new generation. The antherozoids (B, c, d), when set free from the antheridium a, swarm over the exterior of the oögonium b, and have actually been seen to penetrate its cavity through an aperture which opportunely forms in its wall, and to come into contact with the surface of its endochrome-mass, over which they diffuse themselves; there they seem to undergo dissolution, their substance mingling itself with that of the germ-cell; and the endoplasm of the 'oöspore' thus formed, which had previously no proper investment of its own, soon begins to form an envelope (c, b), which increases in thickness and strength, until it has acquired such a density as enables it to afford a firm protection to its contents.

250. The Microscopist who wishes to study the development of 'zoöspores,' as well as several other phenomena of this low type of vegetation, may advantageously have recourse to the little plant termed *Achlya prolifera*, which grows parasitically upon the bodies of dead Flies lying in the water, but also not unfrequently attaches itself to the gills of Fish, and is occasionally found on the bodies of Frogs.<sup>1</sup> Its tufts

FIG. 148.

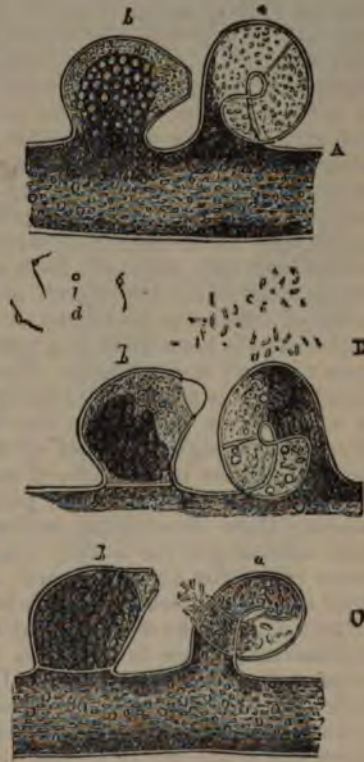

Successive phases of Generative process in *Vaucheria sessilis*:—At A are seen one of the 'horns' or Antheridia (a) and one of the Capsules (b), as yet unopened; at B the antheridium is seen in the act of emitting the antherozoids (c), of which many enter the opening at the apex of the capsule, whilst others (d) which do not enter it, display their flagella when they become motionless; at C the orifice of the capsule is closed again by the formation of a proper coat around its endochrome, thus constituting an oöspore.

<sup>1</sup> This Plant, though, as an inhabitant of water, formerly ranked among *Algae*, is now more generally regarded as belonging to the group of *Fungi*, on account of its incapacity for the production of chlorophyll, and its parasitism on the bodies of Animals, from whose juices its cells seem to draw their nourishment.

are distinguishable by the naked eye as clusters of minute colorless filaments; and these are found, when examined by the microscope, to be long tubes, devoid of all partitions, extending themselves in various directions. The tubes contain a colorless lightly-granular protoplasm, the particles of which are seen to move slowly in streams along the walls, as in *Chara*, the currents occasionally anastomosing with each other (Fig. 149, c). Within about thirty-six hours after the first appearance of the parasite on any body, the protoplasm begins to accumulate in the dilated ends of the filaments, each of which is cut off from the remainder by the formation of a partition; and within this dilated cell the movement of the protoplasm continues for a time to be distinguishable. Very speedily, however, its endoplasm shows the appearance of being broken up into a large number of distinct masses, which are at first in close contact with each other, and with the walls of the cell (Fig. 149, A), but which gradually become more isolated, each seeming to acquire a proper cell-wall; they then begin to move about within the parent-cell; and, when quite mature, they are set free by the rupture of its wall (B), to go forth and form new attachments, and to develop themselves into tubiform cells resembling those from which they sprang. Each of these 'motile gonidia' is possessed of two flagella; their movements are not so powerful as those of the zoöspores of *Vaucheria*, and come to an end sooner.—The Generative process in this type is performed in a manner that may be regarded as an advance upon ordinary conjugation. The end of one of the long tubiform cells enlarges into a globular dilatation, the cavity of which becomes shut off by a transverse partition. Its contained endoplasm divides into two, three, or four segments, each of which takes a globular form, and is then fertilized by the penetration of an antheridial tube which comes off from the filament a little below the partition.<sup>1</sup> The 'oöspores' thus produced, escaping from the globular cavities, acquire firm envelopes, and may remain unchanged for a long time even in water, when no appropriate *nidus* exists for them; but will quickly germinate if a dead insect or other suitable object be thrown-in.

251. One of the most curious forms of this group is the *Hydrodictyon utriculatum*, which is found in fresh-water pools in the midland and southern counties of England. Its frond consists of a green open network of filaments, acquiring, when full grown, a length of from four to six inches, and composed of a vast number of cylindrical tubular cells, which attain the length of four lines or more, and adhere to each other by their rounded extremities, the points of junction corresponding to the knots or intersections of the network. Each of these cells may form within itself an enormous multitude (from 7,000 to 20,000) of 'swarm-spores,' which, at a certain stage of their development, are observed in active motion in its interior; but of which clusters are afterwards formed by their mutual adhesion, that are set free by the dissolution of their envelopes, each cluster, or 'macro-gonidium,' giving origin to a new plant-net. Besides these bodies, however, certain cells produce from 30,000 to 100,000 'micro-gonidia' of longer shape, each furnished with four long flagella and a red spot; these escape from the cell in a swarm, move freely in the water for some time, and then come to rest and sink to the bottom, where they remain heaped in green masses. It appears from the observations of Pringsheim,<sup>2</sup> that they become surrounded with

<sup>1</sup> See Prof. Sachs's "Text-book of Botany" (translated by A. W. Bennett), p. 12.

<sup>2</sup> "Quart. Journ. of Microsc. Science," N.S., Vol. ii. (1862), pp. 54, 104.

a firm cellulose envelope, and may remain for a considerable length of time in a dormant condition, in which they are known as 'statospores,' and that in this state they are able to endure being completely dried up without the loss their vitality, provided that they are secluded from the action of Light, which causes them to wither and die. In this state they bear a strong resemblance to the cells of *Protococcus*.—The first change that manifests itself in them is a simple enlargement; next, the endochrome divides itself successively into distinct masses, usually from two to five in number; and these, when set free by the giving way of the enveloping membrane, present the characters of ordinary 'zoöspores,' each of them possessing one or two flagella at its anterior semi-transparent extremity. Their motile condition, however, does not last long,

FIG. 149.

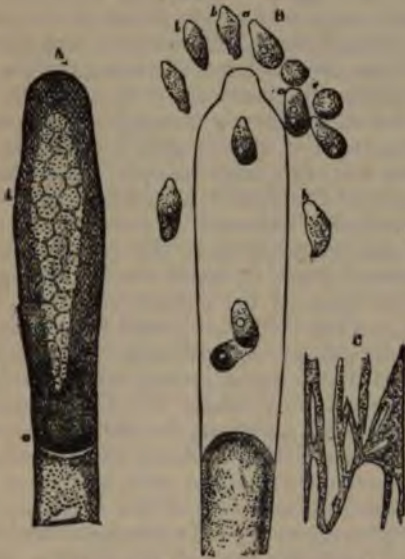

Development of *Achlya prolifera*.—A, dilated extremity of a filament *b*, separated from the rest by a partition *a*, and containing gonidia in progress of formation;—B, conceptacle discharging itself, and setting free gonidia, *a b, c*;—C, portion of filament, showing the course of the circulation of granular protoplasm.

FIG. 150.



Process of cell-multiplication in *Conferva glomerata*.—A, portion of filament with incomplete separation at *a*, and complete partition at *b*; B, the separation completed, a new cellulose partition being formed at *a*; C, formation of additional layers of cellulose wall *c*, beneath the mucous investment *d*, and around the ectoplasm *a*, which incloses the endochrome *b*.

often giving place to the motionless stage before they have quite freed themselves from the parent-cell; they then project long angular processes, so as to assume the form of irregular polyhedra, at the same time augmenting in size; and the endochrome contained within each of these breaks-up into a multitude of gonidia, which are at first quite independent and move actively within the cell-cavity, but soon unite into a network that becomes invested with a gelatinous envelope, and speedily increases so much in size as to rupture the containing cell-wall, on escaping from which it presents all the essential characters of a young *Hydrodictyon*. Thus, whilst this plant multiplies itself by 'macrogonidia' during the period of its most active vegetation, this method of multiplication by 'micro-gonidia' appears destined to secure its perpetuation under conditions that would be fatal to it in its perfect form.—



The rapidity of the growth of this curious organism is not one of the least remarkable parts of its history. The individual cells of which the net is composed, at the time of their emersion as 'gonidia,' measure no more than 1-2500th of an inch in length; but in the course of a few hours, they grow to a length of from 1-12th to 1-3d of an inch.—Nothing has been as yet ascertained respecting the sexual Generation of this type.

252. Almost every pond and ditch contains some members of the Family *Confervaceæ*; but they are especially abundant in moving water; and they constitute the greater part of those green threads which are to be seen attached to stones, with their free ends floating in the direction of the current, in every running stream, and upon almost every part of the sea-shore, and which are commonly known under the name of 'silk-weeds,' or 'crow-silk.' Their form is usually very regular, each thread being a long cylinder made up by the union of a single file of short cylindrical cells united to each other by their flattened extremities; sometimes these threads give off lateral branches, which have the same structure. The endochrome, though usually green, is occasionally of a brown or purple hue; it is sometimes distributed uniformly throughout the cell (as in Fig. 150), whilst in other instances it is arranged in a pattern of some kind, as a network or spiral; but this may be only a transitory stage in its development.—The plants of this family are extremely favorable subjects for the study of the method of cell-multiplication by *binary subdivision*. This process usually takes place only in the *terminal cell*; and it may be almost always observed there in some one of its stages. The first step is seen to be the subdivision of the endochrome, and the inflexion of the ectoplasm around it (Fig. 150, A, a); and thus there is gradually formed a sort of hour-glass contraction across the cavity of the parent-cell, by which it is divided into two equal halves (B). The two-surfaces of the infolded utricle produce a double layer of cellulose-membrane between them; this is not confined, however, to the contiguous surfaces of the young cells, but extends over the whole of their exterior, so that the new septum becomes continuous with a new layer that is formed throughout the interior of the cellulose wall of the original cell (c). Sometimes, however, as in *Conferva glomerata* (a common species), new cells may originate as branches from any part of the surface, by a process of budding; which, notwithstanding its difference of mode, agrees with that just described in its essential character, being the result of the subdivision of the original cell. A certain portion of the ectoplasm seems to undergo increased nutrition, for it is seen to project, carrying the cellulose envelope before it, so as to form a little protuberance; and this sometimes attains a considerable length, before any separation of its cavity from that of the cell which gave origin to it begins to take place. This separation is gradually effected, however, by the infolding of the ectoplasm, just as in the preceding case: and thus the endochrome of the branch-cell becomes completely severed from that of the stock. The branch then begins to elongate itself by the subdivision of its first-formed cell; and this process may be repeated for a time in all the cells of the filament, though it usually comes to be restricted at last to the terminal cell.—The *Confervaceæ* multiply themselves by zoöspores, which are produced within their cells, and are then set free, just as in the *Ulvaceæ* (§ 245).

253. A true sexual Generation has been observed in several *Confervaceæ*, and is probably universal throughout the group. It is presented

under a very interesting form in a plant termed *Sphæroplea annulina*, the development and generation of which have been specially studied by Dr. F. Cohn.<sup>1</sup> The 'oöspore,' which is the product of the sexual process to be presently described, is filled when mature with a red oil, and is enveloped by two membranes, of which the outer one is furnished with stellate prolongations (Plate X., fig. 1). When it begins to vegetate, its endochrome breaks up—first into two halves (fig. 2), and then by successive subdivisions into numerous segments (figs. 3, 4), at the same time becoming green towards its margin. These segments, set free by the rupture of their containing envelope, escape as 'micro-gonidia,' which are at first rounded or oval, each having a semi-transparent beak whence proceed two flagella, but which gradually elongate so as to become fusiform (fig. 5), at the same time changing their color from red to green. These move actively for a time, and then, losing their motile power, begin to develop themselves into filaments. The first stage in this development consists in the elongation of the cell, and the separation of the endochrome of its two halves by the interposition of a vacuole (fig. 6); and in more advanced stages (figs. 7, 8) a repetition of the like interposition gives to the endochrome that annular arrangement from which the plant derives its specific name. This is seen at *a*, fig. 9, as it presents itself in the filaments of the adult plant; whilst at *b*, in the same figure, we see a sort of frothy appearance which the endochrome comes to possess through the multiplication of the vacuoles. The next stage in the development of the filaments that are to produce the oöspores, consists in the aggregation of the endochrome into definite masses (as seen at fig. 10, *a*), which soon become star-shaped (as seen at *b*), each one being contained within a distinct compartment of the cell. In a somewhat more advanced stage (fig. 11, *a*), the masses of endochrome begin to draw themselves together again; and they soon assume a globular or ovoidal shape (*b*), whilst at the same time definite openings (*c*) are formed in their containing cell-wall. Through these openings the 'antherozoids' developed within other filaments gain admission, as shown at *d*, fig. 12; and they seem to dissolve away (as it were) upon the surface of the before-mentioned masses, which soon afterwards become invested with a firm membranous envelope, as shown in the lower part of fig. 12. These undergo further changes whilst still contained within their tubular parent-cells; their color passing from green to red, and a second investment being formed within the first, which extends itself into stellate prolongations, as seen in fig. 13; so that, when set free, they precisely resemble the mature oöspores which we have taken as the starting-point in this curious history. Certain of the filaments (fig. 14), instead of giving origin to spores, have their annular collections of endochrome converted into 'antherozoids,' which, as soon as they have disengaged themselves from the mucilaginous sheath that envelops them, move about rapidly in the cavity of their containing cell (*a*, *b*) around the large vacuoles which occupy its interior; and then make their escape through apertures (*c*, *d*) which form themselves in its wall, to find their way through similar apertures into the interior of the spore-bearing cells, as already described. These antherozoids are shown in fig. 15, as they appear when swimming actively through the water by means of the two flagella which each possesses.—The peculiar interest of this history consists in the entire absence of any special organs for the Generative process,

<sup>1</sup> "Ann. des Sci. Nat.," 4ème Sér., Botan., Tom. v., p. 187.

## PLATE X

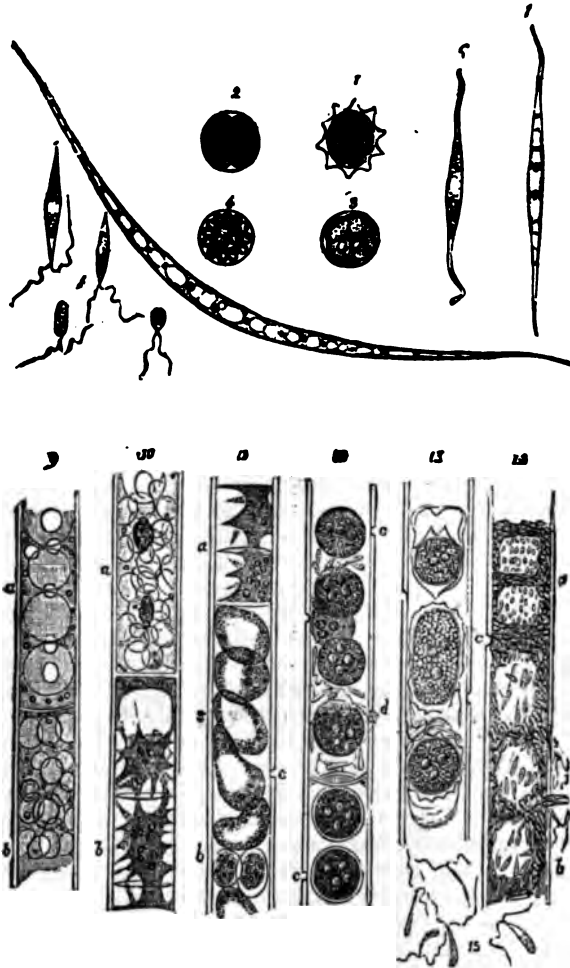

DEVELOPMENT AND REPRODUCTION OF SPHAEROPLEA ANNULINA (after Cohn).

Fig. 1. Oöspore, of a red color, having its outer membrane furnished with stellate prolongations.

- 2, 3, 4. Successive stages of segmentation of the oöspore.
5. Fusiform flagellated zoöspores set free by the rupture of the coats of the oöspore.
- 6, 7, 8. Successive stages of development of zoöspore into a filament.
9. Immature filament, showing at *a* the annulation of the endochrome produced by the regular arrangement of vacuoles, and at *b*, the frothy appearance produced by the multiplication of vacuoles.
10. More advanced stage, showing at *a* the aggregation of the endochrome into definite masses which become star-shaped as seen at *b*.
11. The star-shaped masses of endochrome, *a*, draw themselves together again and become ovoidal, as at *b*; definite openings, *c*, show themselves in the cell-wall.
12. Entrance of the antherozoids, *d*, through the openings, *c*, *c*.
13. Formation of mature oöspores within the filament.
14. Contents of another filament, *a*, becoming converted into antherozoids, which move about at *b* within their containing cell, and escape (as seen at *d*) through the opening *c*.
15. Antherozoids swimming freely by means of two flagella.



the ordinary filamentous cells developing oöspores on the one hand, and antherozoids on the other; and in the simplicity of the means by which the fecundating process is accomplished.

254. The *Edogonia* resemble *Confervaceæ* in general aspect and habit of life, but differ from them in some curious particulars. As the component cells of the filaments extend themselves longitudinally, new rings of cellulose are formed successively, and intercalated into the cell-wall at its upper end, giving it a ringed appearance. Only a single large zoöspore is set free from each cell; and its liberation is accomplished by the almost complete fission of the wall of the cell through one of these rings, a small part only remaining unleft, which serves as a kind of hinge whereby the two parts of the filament are prevented from being

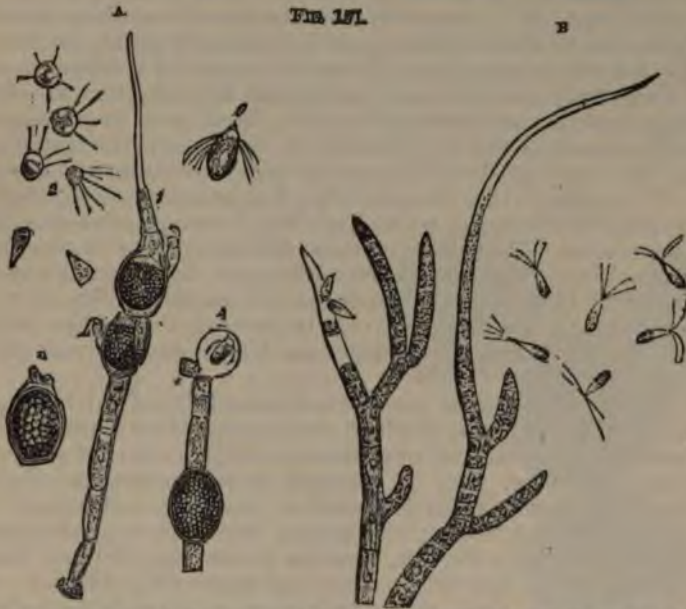

A. Sexual generation of *Edogonium ciliatum*:—1, filament with two oöspores in process of formation, the lower one having two androspores attached to its exterior, the contents of the upper one in the act of being fertilized by the entrance of an antherozoid set free from the interior of its androspore; 2, free antherozoids; 3, mature oöspore, still invested with the cell-membrane of the parent filament; 4, portions of a filament bearing sperm cells, from one of which an androspore is being set free; 5, liberated androspore.

B. Branches of *Chatophora elegans*, in the act of discharging flagellated zoöspores, which are seen, as in motion, on the right.

altogether separated. Sometimes the zoöspore does not completely extricate itself from the parent-cell; and it may begin to grow in this situation, the root-like processes which it puts forth being extended into the cavity. Professor A. M. Edwards (U. S.) states that he has seen the so-called 'motile spores' of the *Edogonium* develop into objects exactly resembling *Euglenæ*, and finally reproducing "a filament exactly like that from which the original green spore was projected." He further asserts he has seen the cell-contents of *Edogonium* develop into forms identical with several genera of Ehrenberg's Polygastric Animalcules.<sup>1</sup>

<sup>1</sup>"Monthly Microsc. Journal," Vol. viii. (1872), p. 28.

Observations of an analogous character were previously made by Cohn and Itzigsohn.

255. In their generative process, also, the *Cedogoniæ* show a curious departure from the ordinary type; for whilst the 'oöspores' are formed within certain dilated cells of the ordinary filament (Fig. 151, A, 1), and are fertilized by the penetration of 'antherozoids' (2), these antherozoids are not the immediate product of the sperm-cells of the same or of another filament, but are developed within a body termed an 'andros pore' (5), which is to be set free from within a sperm-cell (4), and which, being furnished with a circular fringe of cilia, and having motile powers, very strongly resembles an ordinary zoöspore. This *andros pore*, after its period of activity has come to an end, attaches itself to the outer surface of a germ-cell, as shown at 1, b; it then undergoes a change of shape, and a sort of lid drops off from its free extremity as seen in the upper part of 1, by which its contained antherozoids (2) are set free; and at the same time an aperture is formed in the wall of the germ-cell, by which the antherozoid enters its cavity, and fertilizes its endoplasm by dissolving upon it and blending with it. This mass then becomes an oöspore (3), invested with a thick wall of its own, but still retains more or less of the envelope derived from the cell within which it was developed.<sup>1</sup> It is probable that the same thing happens in many *Confervaceæ*, and that some of the bodies which have been termed 'micro-gonidia' are really androspores.—The offices of these different classes of reproductive bodies are only now beginning to be understood; and the inquiry is one so fraught with Physiological interest, and, from the facility of growing these plants in Aquaria, may be so easily pursued, that it may be hoped that the zeal of Microscopists will not long leave any part of it in obscurity.

256. The *Chatophoraceæ* constitute a beautiful and interesting little group of Confervoid plants, of which some species inhabit the sea, whilst others are found in fresh and pure water,—rather in that of gently moving streams, however, than in strongly flowing currents. Generally speaking, their filaments put forth lateral branches, and extend themselves into arborescent fronds; and one of the distinctive characters of the group is afforded by the fact, that the extremities of these branches are usually prolonged into bristle-shaped processes (Fig. 151, B). As in many preceding cases, these plants multiply themselves by the conversion of the endochrome of certain of their cells into 'zoöspores;' and these, when set free, are seen to be furnished with four flagella. 'Resting-spores' have also been seen in many species; and it is probable that these, as in *Confervaceæ*, are really oöspores.

257. The *Batrachospermeæ*, whose name is indicative of the strong resemblance which their beaded filaments bear to frog spawn, are now ranked as humble fresh-water forms of a far higher marine group of Algæ, the *Rhodospirmeæ* or Red Sea-weeds (§ 330). But they deserve special notice here on account of the simplicity of their structure, and the extreme beauty of the objects they afford to the Microscopist (Fig. 152). They are chiefly found in water which is pure and gentle-flowing. "They are so extremely flexible," says Dr. Hassall, "that they obey the slightest motion of the fluid which surrounds them; and nothing can surpass the ease and grace of their movements. When removed from the

<sup>1</sup> See Pringsheim in "Ann. des Sci. Nat.," 4ème Sér., Botan., Tom. v. (1856), p. 187.

water they lose all form, and appear like pieces of jelly, without trace of organization; on immersion, however, the branches quickly resume their former disposition." Their color is for the most part of a brownish-green; but sometimes they are of a reddish or bluish purple. The central axis of each plant is originally composed of a single file of large cylindrical cells laid end to end; but this is subsequently invested by other cells, in the manner to be presently described. It bears, at pretty regular intervals, whorls of short radiating branches, each of them composed of rounded cells, arranged in a bead-like row, and sometimes subdividing again into two, or themselves giving off lateral branches. Each of the primary branches originates in a little protuberance from the primitive cell of the central axis, precisely after the manner of the lateral cells of *Conferva glomerata* (§ 252); as this protuberance increases in size, its cavity is cut off by a septum, so as to render it an independent cell; and by the continual repetition of the process of binary subdivision, this single cell becomes converted into a beaded filament. Certain of these branches, however, instead of radiating from the main axis, grow downwards upon it, so as to form a closely-fitting investment that seems properly to belong to it. Some of the radiating branches grow out into long transparent points, like those of *Chætophoraceæ*; and within those are produced 'antherozoids,' which, though not endowed with the power of spontaneous movement, find their way to the germ-cells contained in other parts of the filaments; and by the fertilization of the contents of these are produced 'oöspores,' which are seen as dark bodies lying in the midst of the whorls of branches (Fig. 152).

258. Among the highest of the Algæ in regard to the complexity of their Generative apparatus, which contrasts strongly with the general simplicity of their structure, is the Family of *Characeæ* (ranked by some Botanists as a group of primary importance); some members of which have received a large amount of attention from Microscopists, on account

of the interesting phenomena they exhibit. These humble plants are for the most part inhabitants of fresh waters, and are found rather in such as are still, than in those which are in motion; one species, however, may be met with in ditches whose waters are rendered salt by communication with the sea. They may be easily grown for the purposes of observation in large glass jars exposed to the light; all that is necessary being to pour off the water occasionally from the upper part of the vessel (thus carrying away a film that is apt to form on its surface), and to replace this by fresh water. Each plant is composed of an assemblage of long tubiform cells, placed end to end; with a distinct central axis, around which the branches are disposed at intervals with great regularity (Fig. 153,  $\Delta$ ). In the genus *Nitella*, the stem and branches are simple cells, which sometimes attain the length of several inches; whilst in the true *Chara* each central tube is surrounded by an envelope of smaller ones, which is



*Batrachospermum montiforme.*



formed as in *Batrachospermæ*, save that the investing cells grow upwards as well as downwards from each node, and meet each other on the stem half-way between the nodes. Some species have the power of secreting carbonate of lime from the water in which they grow, if this be at all impregnated with calcareous matter; and by the deposition of it beneath their teguments they have gained their popular name of 'stoneworts.' The long tubiform cells of *Nitella* afford a very beautiful and instructive display of the phenomenon of *cyclosis*, or rotation of fluid in their interior. Each cell, in the healthy state, is lined by a layer of green oval granules, which cover every part, except two longitudinal lines that remain nearly colorless (Fig. 153, B); and a constant stream of semi-fluid matter containing numerous jelly-like globules is seen to flow over

FIG. 153.

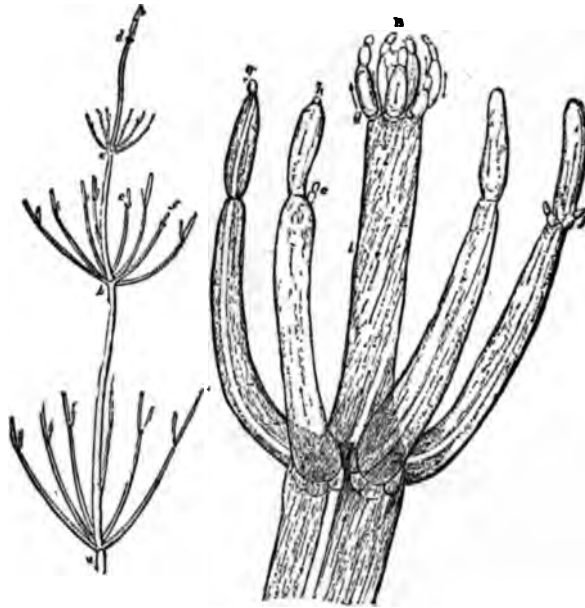

*Nitella flexilis*.—A, stem and branches of the natural size; a, b, c, d, four verticils of branches issuing from the stem; e, f, subdivision of the branches;—B, portion of the stem and branches enlarged; a, b, joints of stem; c, d, verticils; e, f, new cells sprouting from the sides of the branches; g, h, new cells sprouting at the extremities of the branches.

the green layer, the current passing up one side, changing its direction at the extremity, and flowing down the other side, the ascending and descending spaces being bounded by the transparent lines just mentioned. That the currents are in some way directed by the layer of granules, appears from the fact noticed by Mr. Varley,<sup>1</sup> that if accident damages or removes them near the boundary between the ascending and descending currents, a portion of the fluid of the two currents will intermingle by passing the boundary; whilst, if the injury be repaired by the development of new granules on the part from which they had been detached, the circulation resumes its regularity, no part of either current passing the boundary. In the young cells, however, the rotation may be seen

<sup>1</sup> "Transactions of the Microscopical Society," 8d Series, Vol. ii., p. 90.

before this granular lining is formed. The rate of the movement is affected by anything that influences the vital activity of the Plant; thus, it is accelerated by moderate warmth, whilst it is retarded by cold; and it may be at once checked by a slight electric discharge through the plant. The moving globules, which consist of starchy matter, are of various sizes; being sometimes very small and of definite figure, whilst in other instances they are seen as large irregular masses, which appear to be formed by the aggregation of the smaller particles.' The production of new cells for the extension of the stem or branches, or for the origination of new whorls, is not here accomplished by the subdivision of the parent-

FIG. 154.

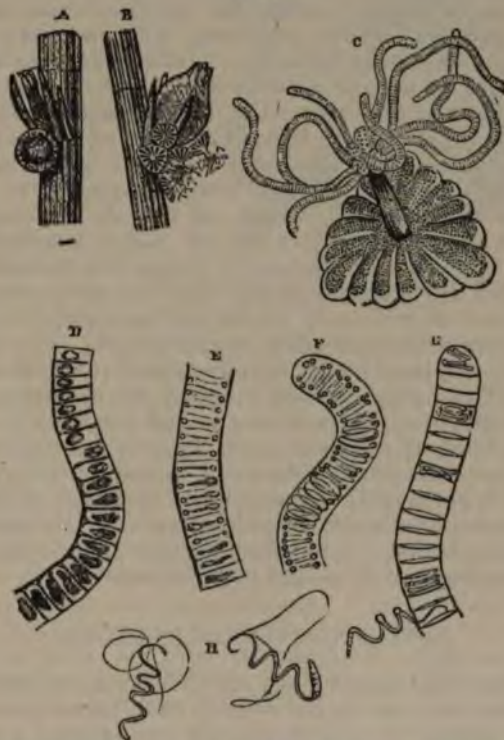

Generative organs of *Chara fragilis*.—A, antheridium or 'globule' developed at the base of pistillidium or 'nucule';—B, nucule enlarged, and globule laid open by the separation of its valves;—C, one of the valves, with its group of antheridial filaments, each composed of a linear series of cells, within every one of which an antherozoid is formed;—in D, E, and F, the successive stages of this formation are seen:—and at G is shown the escape of the mature antherozoids, H.

cell, but takes place by the method of out-growth (Fig. 153, B, e, f, g, h), which, as already shown (§ 252), is nothing but a modification of the usual process of cell-multiplication: in this manner, the extension of the

This interesting phenomenon may be readily observed, by taking a small portion of the plant out of the water in which it is growing, and either placing it in a large Aquatic box (§ 122) or in the Zoöphyte-trough (§ 124), or laying it on the glass Stage-plate (§ 120) and covering it with thin glass. A portion of *Chara* or *Nitella* placed in the Growing-slide (§ 131) may be kept under observation for many days together.

individual plant is effected with considerable rapidity. When these plants are well supplied with nutriment, and are actively vegetating under the influence of light, warmth, etc., they not unfrequently develop 'bulbels,' or 'gonidia,' which are little clusters of cells, filled with starch, that sprout from the sides of the central axis, and then, falling off, evolve the long tubiform cells characteristic of the plant from which they were produced. The *Characeæ* may also be multiplied by artificial subdivision; the separated parts continuing to grow under favorable circumstances, and gradually developing themselves into the typical form.

259. The Generative apparatus of *Characeæ* consists of two sets of bodies, both of which grow at the bases of the branches (Fig. 154, A, B): one set, formerly known as 'globules,' are really *antheridia*; whilst the other, known as 'nucules,' contain the germ-cells, and are true *pistillidia*. The 'globules,' which are nearly spherical, have an envelope made up of eight triangular valves (B, C), often curiously marked, which inclose a nucleus of a light reddish color: this nucleus is principally composed of a mass of filaments rolled up compactly together; and each of these filaments (c) consists, like a *Conferva*, of a linear succession of cells. In every one of these cells there is formed, by a gradual change in its contents (the successive stages of which are seen at D, E, F), a spiral thread of two or three coils, which, at first motionless, after a time begins to move and revolve within the cell; and at last the cell-wall gives way, and the spiral thread makes its escape (G), partially straightens itself, and moves actively through the water for some time (H) in a tolerably determinate direction, by the lashing action of two long and very delicate filaments with which they are furnished. The exterior of the 'nucule' (A, B) is formed by five spirally-twisted tubes, that give it a very peculiar aspect; and these inclose a central sac containing protoplasm, oil, and starch-globules. At a certain period the spirally-twisted tubes, which form a kind of crown around the summit, separate from each other, leaving a canal that leads down to the central germ-cell or *oö-sphere*; and it is probable that through this canal the antherozoids make their way down to perform the act of fertilization. Ultimately the nucule falls off like a seed; and the fertilized germ-cell, or 'oöspore,' gives origin to a single new plant by a kind of germination.

#### DESMIDIACEÆ AND DIATOMACEÆ.

260. Among those simple *Algæ* whose Generative process consists in the 'conjugation' of two similar cells (§ 235), there are two groups of such peculiar interest to the Microscopist as to need a special notice; these are the *Desmidiaceæ* and the *Diatomaceæ*. Both of them were ranked by Ehrenberg and many other Naturalists as Animalcules; but

---

<sup>1</sup> A full account of the *Characeæ* will be found in Prof. Sachs's "Text-book of Botany" (translated by A. W. Bennett), p. 278.—Various observers have asserted that particles of the protoplasmic contents of the cells of the *Characeæ*, when set free by the rupture of their cells, may continue to live, move, and grow as independent Rhizopods. But the writer is disposed to think that the phenomena thus represented are rather to be regarded as cases of parasitism; the decaying cells of *Nitella* having been found by Cienkowski ('Beiträge zur Kenntniss der Monaden,' in "Arch. f. Mikr. Anat." Bd. i., 1865, p. 203) to be inhabited by minute spindle-shaped ciliated bodies, which seem to correspond with the 'spores' of the *Myxomycetes* (§ 322), going through an amoeboid stage, and then producing a *plasmodium*, which, after undergoing a sort of encysting process, finally 'breaks up' into spindle-shaped particles resembling those found in the *Nitella*-cells.



the fuller knowledge of their life-history, and the more extended acquaintance with the parallel histories of other simple forms of Vegetation, which have been gained during the last twenty years, are now generally accepted as decisive of their Vegetable nature.

261. The DESMIDIACEÆ<sup>1</sup> are minute plants of a green color, growing in fresh water; generally speaking, the cells are independent of each other (Figs. 155–158); but sometimes those which have been produced by binary subdivision from a single primordial cell, remain adherent one to another in linear series, so as to form a filament (Fig. 160). The tribe is distinguished by two peculiar features: one of these being the semblance of a division of each cell into two symmetrical halves by a 'sutural line,' which is sometimes so decided as to have led to the belief that the cell

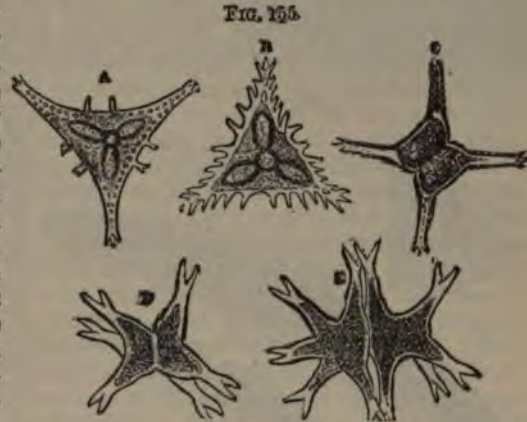

Various species of *Staurastrum*:—A, *S. vestitum*; B, *S. aculeatum*; C, *S. paradoxum*; D, E, *S. brachiatum*.

is really double (Fig. 158, A), though in other cases it is merely indicated by a slight notch; whilst the other is the frequency of projections from the surface, which are sometimes short and inconspicuous (Fig. 158), but are often elongated into spines, presenting a very symmetrical arrangement (Fig. 155). These projections are generally formed by the cellulose envelope alone; which possesses an almost horny consistence, so as to retain its form after the discharge of its contents (Figs. 158, B, D, 162, E), but does not include any mineral ingredient, either calcareous or siliceous, in its composition; in other instances, however, they are formed by a notching of the margin of the cell (Fig. 157) which may affect only the outer casing, or may extend into the cell-cavity. The outer coat is surrounded by a very transparent sheet of gelatinous substance, which is sometimes very distinct (as shown in Fig. 160), whilst in other cases its existence is only indicated by its preventing the contact of the cells. The outer coat incloses a primordial utricle, which is not always closely adherent to it; and this immediately surrounds the endochrome, which occupies nearly the whole interior of the cell, and in certain stages of its growth is found to contain starch-granules.—Many of these Plants have a power of slowly changing their place, so that they approach the light side of the vessels in which they are kept, and will even traverse the field of the Microscope under the eye of the observer; by what agency this movement is effected has not yet been certainly made out.

262. A 'cyclosis' may be readily observed in many *Desmidiaceæ*; and is particularly obvious along the convex and concave edges of the cell of any vigorous specimen of *Closterium*, with a magnifying power of 250 or

<sup>1</sup> Our first accurate knowledge of this group dates from the publication of Mr. Ralfs's admirable Monograph in 1848. Later information in regard to it will be found in the Section contributed by Mr. W. Archer to the 4th Edition of Pritchard's 'Infusoria.'

300 diameters (Fig. 156, A, B). By careful focussing, the flow may be seen in broad streams over the whole surface of the endochrome; and these streams detach and carry with them, from time to time, little oval or globular bodies (A, b), which are put-forth from it, and are carried by the course of the flow to the transparent spaces at the extremities, where they join a crowd of similar bodies. In each of these spaces (B), a protoplasmic flow proceeds from the somewhat abrupt termination of the endochrome, towards the obtuse end of the cell (as indicated by the interior arrows); and the globules it contains are kept in a sort of twisting movement on the inner side (a) of the primordial utricle. Other currents are seen apparently external to it, which form three or four distinct courses of globules, passing towards and away-from c (as indicated by the outer arrows), where they seem to encounter a fluid jetted towards them as if through an aperture in the primordial utricle at the apex of the chamber; and here some communication between the inner and the outer currents appears to take place.<sup>1</sup>—Another curious movement is often to be

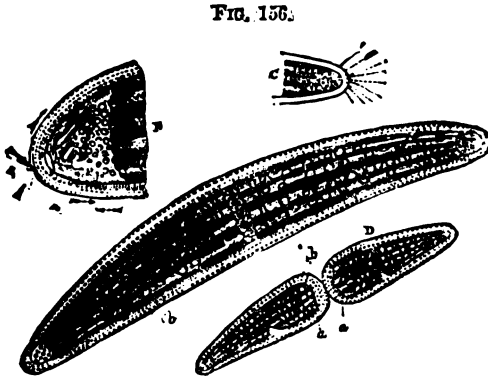

FIG. 156.  
Cyclois in *Closterium lunula*.—A, cell showing central separation at *a*, in which the large globules, *b*, are not seen;—B, one extremity enlarged, showing the movement of globules in the colorless space;—C, external jet produced by pressure on the cell, probably through an opening in the cellulose envelope;—D, cell in a state of self-division.

witnessed in the interior of the cells of members of this family, especially the various species of *Cosmarium*, which has been described as 'the swarming of the granules,' from the extraordinary resemblance which the mass of particles of endochrome in active vibratory motion bears to a swarm of bees. This motion continues for some time after the particles have been expelled by pressure from the interior of the cell; and it does not seem to depend (like that of true 'zoöspores') upon the action of cilia or flagella, but rather to be a more active form of the molecular movement common to other minute particles freely suspended in fluid (§ 155). It has been supposed that the 'swarming' is related to the production of zoöspores; but for this idea there does not seem any adequate foundation.

<sup>1</sup> See Lord S. G. Osborne's communications to the "Quart. Journ. of Microsc. Sci.," Vol. ii. (1854), p. 234, and Vol. iii. (1855), p. 54.—Although the movement is an unquestionable fact, yet there can be no hesitation in regarding the appearance of *ciliary action* described by that observer as an optical illusion; as was early pointed out by Mr. Wenham in the same Journal, Vol. iv., 1856, p. 158.—The character of this movement has been described by a recent observer (Mr. A. W. Wills) as one of ebb and flow, alternately towards and from the ends, in delicate longitudinal bands or streams; its direction in any one band being usually reversed every few seconds; while in different bands the flow may be in opposite directions at the same time. The clear spaces at the ends of the cell he affirms to be contractile vesicles; and these (he says) can be seen under a 1-4th or 1-6th inch objective to be undergoing incessant though slight changes in form, with which the flow of the currents can be distinctly connected. (See "Midland Naturalist," 1880, p. 187, quoted in "Journ. of Roy. Microsc. Soc.," Vol. iii. (1880), p. 845.

<sup>2</sup> See Archer in "Quart. Journ. of Microsc. Sci.," Vol. viii. (1860), p. 215.



263. When the single cell has come to its full maturity, it commonly multiplies itself by *binary subdivision*; but the plan on which this takes place is often peculiarly modified, so as to maintain the symmetry characteristic of the tribe. In a cell of the simple cylindrical form of those of *Didymoprium* (Fig. 160), little more is necessary than the separation of the two halves at the sutural line, and the formation of a partition between them by the infolding of the primordial utricle; and in this manner, out of the lowest cell of the filament A, a double cell, B, is produced. But it will be observed that each of the simple cells has a bifid wart-like projection of the cellulose wall on either side, and that the half of this projection, which has been appropriated by each of the two new cells, is itself becoming bifid, though not symmetrically; in process of time, however, the increased development of the sides of the cells which remain in contiguity with each other brings up the smaller projections to the dimensions of the larger, and the symmetry of the cells is restored.—In *Closterium* (Fig. 156, D), the two halves of the endochrome first retreat from one another at the sutural line, and a constriction takes place round the cellulose wall; this constriction deepens until it becomes an hour-glass contraction, which proceeds until the cellulose wall entirely closes round the primordial utricle of the two segments; in this state, one half commonly remains passive, whilst the other has a motion from side to side, which gradually becomes more active; and at last one segment quits the other with a sort of jerk. At this time a constriction is seen across the middle of the primordial utricle of each segment, indicating the formation of the sutural band; but there is no division of the cell-cavity, which is that belonging to one of the halves of the original entire cell. The cyclosis, for some hours previously to subdivision, and for a few hours afterwards, runs quite round the obtuse end *a*, of the endochrome; but gradually a transparent space is formed, like that at the opposite extremity, by the retreat of the colored layer; whilst, at the same time, its obtuse form becomes changed to a more elongated and contracted shape. Thus, in five or six hours after the separation, the aspect of each extremity becomes the same, and each half resembles the cell in whose self-division it originated.

264. The process is seen to be performed after nearly the same method in *Staurastrum* (Fig. 155, D, E); the division taking place across the central constriction, and each half gradually acquiring the symmetry of the original.—In such forms as *Cosmarium*, however, in which the cell consists of two lobes united together by a narrow isthmus (Fig. 158), the division takes place after a different method; for when the two halves of the outer wall separate at the sutural line, a semiglobular protrusion of the endochrome is put forth from each half; these protrusions are separated from one another, and from the two halves of the original cell (which their interposition carries apart), by a narrow neck; and they progressively increase until they assume the appearance of the half-segments of the original cell. In this state, therefore, the plant consists of a row of four segments, lying end to end, the two old ones forming the extremes, and the two new ones (which do not usually acquire the full size or the characteristic markings of the original before the division occurs) occupying the intermediate place. At last the central fission becomes complete, and two bipartite fronds are formed, each having one old and one young segment: the young segment, however, soon acquires the full size and characteristic aspect of the old one; and the same process, the whole of which may take place within twenty-four hours, is repeated ere



long.<sup>1</sup> The same general plan is followed in *Micrasterias denticulata* (Fig. 157); but as the small hyaline hemisphere, put forth in the first instance from each frustule (A), enlarges with the flowing in of the endochrome, it undergoes progressive subdivision at its edges, first into three lobes (B), then into five (C), then into seven (D), then into thirteen (E), and finally at the time of its separation (F), acquires the characteristic notched outline of its type, being only distinguishable from the older half by its smaller size. The whole of this process may take place within three hours and a half.<sup>2</sup>—In *Sphærozosma*, the cells thus

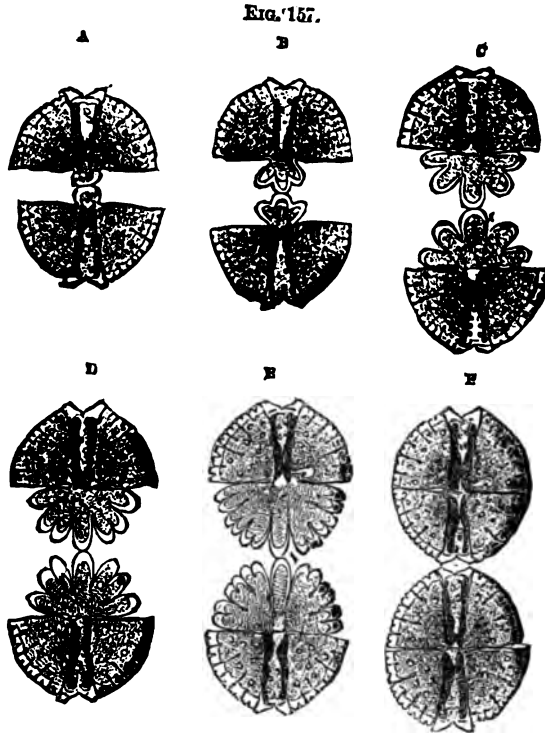

Successive stages of Binary subdivision of *Micrasterias denticulata*.

produced remain connected in rows within a gelatinous sheath, like those of *Didymoprium* (Fig. 160); and different stages of the process may commonly be observed in the different parts of any one of the filaments thus formed. In any such filament, it is obvious that the two oldest segments are found at its opposite extremities, and that each subdivision of the intermediate cells must carry them farther and farther from each other. This is a very different mode of increase from that of the *Confervaceæ*, in which the terminal cell alone undergoes subdivision (§ 252), and is consequently the one last formed.

<sup>1</sup> See the observations of Mrs. Herbert Thomas on *Cosmarium margaritifera*, in "Transact. of Microsc. Society," N.S., Vol. iii. (1855), pp. 33-36. — Several varieties in the mode of subdivision are described in this short record of long-continued observations, as of occasional occurrence.

<sup>2</sup> See Lobb in "Transact. of Microsc. Society," N.S., Vol. ix. (1861), p. 1

265. Although it is probable that the *Desmidiaceæ* generally multiply themselves also by the subdivision of their endochrome into a number of zoöspores, only one undoubted case of the kind has yet been recorded (the *Pediasireæ*, § 270, being no longer ranked within this group); that, namely, of *Docidium Ehrenbergi*, whose elongated cell puts forth from the vicinity of the sutural line, one, two, or three tubular extensions resembling the finger of a glove, through which there pass out from 20 to 50 motile *microgonidia* formed by the breaking up of the endochrome of the neighboring portion of each segment.<sup>1</sup>

266. Whether there is in this group anything that corresponds to the 'encysting' process (§ 238 note) or the formation of 'stato-spores' (§ 241) in other Protophytes, has not yet been certainly ascertained; but the following observations may have reference to such a condition. It is stated by Focke that the entire endochrome of *Closterium* sometimes retracts itself from the cell-wall, and breaks itself up into a number of globules, every one of which acquires a very firm envelope. And it is affirmed by Mr. Jenner that "in all the *Desmidiaceæ*, but especially in *Closterium* and *Micrasterias*, small, compact, seed-like bodies of a blackish color are at times to be met with. Their situation is uncertain, and their number varies from one to four. In their immediate neighborhood the endochrome is wanting, as if it had been required to form them; but in the rest of the frond it retains its usual color and appearance." It seems likely that, when thus inclosed in a firm cyst, the gonidia are more capable of preserving their vitality, than they are when destitute of such a protection; and that in this condition they may be taken up and wafted through the air, so as to convey the species into new localities.

267. The proper Generative process in the *Desmidiaceæ* is always accomplished by the act of 'conjugation;' which commences with the dehiscence of the firm external envelope of each of the conjugating cells, so as to separate it into two valves (Fig. 158, c, d; Fig. 159, c). The contents of each cell thus set free without any distinct investment, blend with those of the other; and a 'zygospore' is formed by their union, which soon acquires a truly membranous envelope.<sup>2</sup> This envelope is at first very delicate, and is filled with green and granular contents; by degrees the envelope acquires increased thickness, and its contents become brown or red. The surface of the zygospore is sometimes smooth, as in *Closterium* and its allies (Fig. 159); but in the *Cosmarieæ*, it becomes granular, tuberculated, or even spinous (Fig. 158, d), the spines being sometimes simple and sometimes forked at their extremities.<sup>3</sup>—The mode in which conjugation takes place in the filamentous species constituting the *Desmidiææ* proper, is, however, in many respects different. The filaments first separate into their component joints; and when two cells approach in conjugation, the outer cell-wall of each splits or gapes at that part which adjoins the other cell, and a new growth takes place, which forms a sort of connecting tube that unites the cavities of the two cells (Fig. 160, d, e). Through this tube the entire endochrome of one cell passes over into the cavity of the other (d); and the two are com-

<sup>1</sup> See Archer in "Quart. Journ. of Microsc. Sci.," Vol. viii. (1860), p. 227.

<sup>2</sup> In certain species of *Closterium*, as in many of the *Diatomaceæ* (§ 280), the act of conjugation gives origin to two sporangia.

<sup>3</sup> Bodies precisely resembling these, and almost certainly to be regarded as of like kind, are often found fossilized in Flints, and have been described by Ehrenberg as the remains of Animalcules, under the name of *Xanthidia*.

mingled so as to form a single mass (E), as is the case in many of the *Conjugatæ* (§ 235). The joint which contains the zygospore can scarcely be distinguished at first (after the separation of the empty cell), save by the greater density of its contents; but the proper coats of the zygospore gradually become more distinct, and the enveloping cell-wall disappears.—The subsequent history of the zygospores has hitherto been made out in only a few cases. From the observations of Mrs. H. Thomas (*loc. cit.*) on *Cosmarium*, it appeared that each zygospore gives origin, not to a single cell but to a brood of cells; and this view is fully confirmed by Hoffmeister,<sup>1</sup> who speaks of it as beyond doubt that the contents of the zygospores are transformed by repeated binary subdivisions into 8 or 16 cells, which assume the original form of the parent before they are set free by the rupture or diffidence of the inclosing wall. The observations of Jenner and Focke render it probable that the same is the case in *Closterium*; but much has still to be learned in regard to the development of the products of the Generative process, as it is by no means certain

FIG. 158.

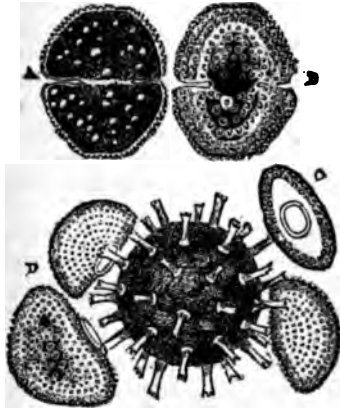

Conjugation of *Cosmarium botrytis*:  
—A, mature cells; B, empty cell-envelope; C, transverse view; D, zygospore with empty cell-envelopes

FIG. 159.

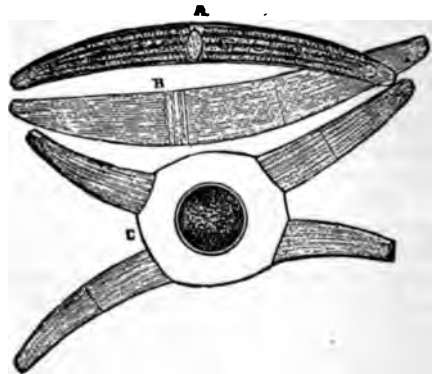

Conjugation of *Closterium striatulum*:—A, ordinary cell; B, empty cell; C, two cells in conjugation, with incipient zygospore.

that they always resemble the parent forms. For it is affirmed by Mr. Ralfs that there are several Desmidiaceæ which never make their appearance in the same pool for two years successively, although their zygospores are abundantly produced—a circumstance which would seem to indicate an ‘alternation of generations.’ It is a subject, therefore, to which the attention of Microscopists cannot be too sedulously directed.

268. The subdivision of this Family into Genera, according to the method of Mr. Ralfs (“British Desmidiæ”), as modified by Mr. Archer (Pritchard’s “Infusoria”), is based in the first instance upon the connection or disconnection of the individual cells; two groups being thus formed, of which one includes all the genera whose cells, when multiplied by binary subdivision, remain united into an elongated filament; whilst the other comprehends all those in which the cells become separated by the completion of the fission. The further division

<sup>1</sup> “Ann. of Nat. Hist.,” 3d Ser., Vol. i. (1858), p. 2.



of the filamentous group, in which the zygospores are always globular and smooth, is based on the fact that in one set of genera the joints are many times longer than they are broad, and that they are neither constricted nor furnished with lateral teeth or projections; whilst in the other set (of which *Didymoprium*, Fig. 160, is an example) the length and breadth of each joint are nearly equal, and the joints are more or less constricted, or have lateral teeth or projecting angles, or are otherwise figured; and it is for the most part upon the variations in these last particulars, that the generic characters are based. The solitary group presents a similar basis for primary division in the marked difference in the proportions of its cells; such elongated forms as *Closterium* (Figs. 156, 159), in which the length is many times the breadth, being thus separated from those in which, as in *Micrasterias* (Fig. 157), *Cosmarium* (Fig. 158), and *Staurastrum* (Fig. 155), the breadth more nearly equals the length. In the former the sporangia are smooth, whilst in the latter they are very commonly spinous and are sometimes quadrate. In this group, the chief secondary characters are derived from the degree of constriction between the two halves of the cell, the division of its margin into segments by incisions more or less deep, and its extension into teeth or spines.

269. The *Desmidiaceæ* are not found in running streams, unless the motion of the water be very slow; but are to be looked-for in standing though not stagnant waters. Small shallow pools that do not dry up in summer, especially in open exposed situations, such as boggy moors, are most productive. The larger and heavier species commonly lie at the bottom of the pools, either spread-out as a thin gelatinous stratum, or collected into finger-like tufts. By gently passing the fingers beneath these, they may be caused to rise towards the surface of the waters, and may then be lifted out by a tin-box or scoop. Other species form a greenish or dirty cloud upon the stems and leaves of other aquatic plants; and these also are best detached by passing the hand beneath them, and 'stripping' the plant between the fingers, so as to carry off upon them what adhered to it. If, on the other hand, the bodies of which we are in search should be much diffused through the water, there is no other course than to take it up in large quantities by the box or scoop, and to separate them by straining through a piece of linen. At first, nothing appears on the linen but a mere stain or a little dirt; but

FIG. 160.



Binary subdivision and conjugation of *Didymoprium Grevillii*.—A, portion of filament, surrounded by gelatinous envelope; B, dividing cell; C, single cell viewed transversely; D, two cells in conjugation; E, formation of zygospore.

by the straining of repeated quantities, a considerable accumulation may be gradually made. This should be then scraped-off with a knife, and transferred into bottles with fresh water. If what has been brought up by hand be richly charged with these forms, it should be at once deposited in a bottle; this at first seems only to contain foul water, but by allowing it to remain undisturbed for a little time, the Desmids will sink to the bottom, and most of the water may then be poured-off, to be replaced by a fresh supply. If the bottles be freely exposed to solar light, these little plants will flourish, apparently as well as in their native pools; and their various phases of multiplication and reproduction may be observed during successive months or even years.—If the pools be too deep for the use of the hand and the scoop, a collecting-bottle attached to a stick (§ 216) may be employed in its stead. The ring-net (§ 216) may also be advantageously employed, especially if it be so constructed as to allow of the ready substitution of one piece of muslin for another. For by using several pieces of previously wetted muslin in succession, a large number of these minute organisms may be separated from the water; the pieces of muslin

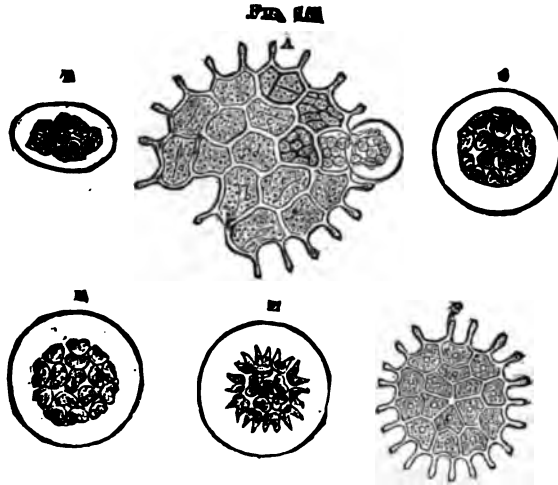

Various phases of development of *Pediastrum granulatum*.

may be brought home folded-up in wide-mouthed bottles, either separately, or several in one, according as the organisms are obtained from one or from several waters; and they are then to be opened out in jars of filtered river-water, and exposed to the light, when the Desmids will detach themselves.

270. *Pediastrææ*.—The members of this family were formerly included in the preceding group; but, though doubtless related to the true *Desmidiaceæ* in certain particulars, they present too many points of difference to be properly associated with them. Their chief point of resemblance consists in the firmness of the outer casing, and in the frequent interruption of its margin either by the protrusion of 'horns' (Fig. 161, A), or by a notching more or less deep (Fig. 162, B); but they differ in these two important particulars, that the cells are not made up of two symmetrical halves, and that they are always found in aggregation, which is not—except in such genera as *Scenodesmus* (*Arthrodesmus*, Ehr.), which

connect this group with the preceding—in linear series, but in the form of discoidal fronds. In this tribe we meet with a form of multiplication by zoöspores aggregated into *macro-gonidia*,<sup>1</sup> which reminds us of the formation of the motile spheres of *Volvox* (§ 239), and which takes place in such a manner that the resultant product may vary greatly in number of its cells, and consequently both in size and in form. Thus in, *Pediasstrum granulatum* (Fig. 161), the zoöspores formed by the subdivision of the endochrome of one cell into gonidia, which may be 4, 8, 16, 32, or 64 in number, escape from the parent frond still inclosed in the inner tunic of the cell; and it is within this that they develop themselves into a cluster resembling that in which they originated, so that whilst the frond normally consists of sixteen cells, it may be composed of either of the just-mentioned multiples or sub-multiples of that number. At A, is seen an old disk, of irregular shape, nearly emptied by the emission of its macro-gonidia, which had been seen to take place within a few hours previously from the cells *a, b, c, d, e*; most of the empty cells exhibit the cross slit through which their contents had been discharged; and where this does not present itself on the side next the observer, it is found on the other. Three of the cells still possess their colored contents, but in different conditions. One of them exhibits an early stage of the subdivision of the endochrome, namely, into two halves, into two halves, one which already appears halved again. Two others are filled by sixteen very closely-crowded gonidia, only half of which are visible, as they form a double layer. Besides these, one cell is in the very act of discharging its gonidia; nine of which have passed forth from its cavity, though still enveloped in a vesicle formed by the extension of its innermost membrane; whilst seven yet remain in its interior. The new-born family, as it appears immediately on its complete emersion, is shown at B; the gonidia are actively moving within the vesicle; and they do not as yet show any indication either of symmetrical arrangement, or of the peculiar form which they are subsequently to assume. Within a quarter of an hour, however, the gonidia are observed to settle-down into one plane, and to assume some kind of regular arrangement, most commonly that seen at C, in which there is a single central body surrounded by a circle of five, and this again by a circle of ten; they do not, however, as yet adhere firmly together. The gonidia now begin to develop themselves into new cells, increase in size, and come into closer approximation (D); and the edge of each, especially in the marginal row, presents a notch, which foreshadows the production of its characteristic 'horns.' Within about four or five hours after the escape of the gonidia, the cluster has come to assume much more of the distinctive aspect of the species, the marginal cells having grown-out into horns (E); still, however, they are not very closely connected with each other; and between the cells of the inner row considerable spaces yet intervene. It is in the course of the second day that the cells become closely applied to each other, and that the growth of the horns is completed, so as to constitute a perfect disk like that seen at F, in which, however, the arrangement of the interior cells does not follow the typical plan.<sup>2</sup>

271. The varieties which present themselves, indeed, both as to the

<sup>1</sup> Solitary zoöspores or *micro-gonidia* have been observed by Braun to make their way out and swim away; but their subsequent history is unknown.

<sup>2</sup> See Prof. Braun on "The Phenomenon of Rejuvenescence in Nature," published by the Ray Society in 1858; and his subsequent Memoir, "Algarum Unicellularum Genera nova aut minus cognita," 1855.



number of cells in each cluster, and the plan on which they are disposed, are such as to baffle all attempts to base specific distinctions on such grounds; and the more attentively the life-history of any one of these plants is studied, the more evident does it appear that many reputed 'species' have no real existence. Some of these, indeed, are nothing else than mere transitory forms; thus it can scarcely be doubted that the specimen represented in Fig. 162, D, under the name of *Pediastrum pertusum*, is in reality nothing else than a young frond of *P. granulatum*, in the stage represented in Fig. 161, E, but consisting of 32 cells. On the other hand, in Fig. 162, E, we see an emptied frond of *P. granulatum*, exhibiting the peculiar surface-marking from which the name of the species is derived, but composed of no more than eight cells. And instances every now and then occur in which the frond consists of only four cells, each of them presenting the two-horned shape. So, again, in Fig. 162, B and C, are shown two varieties of *Pediastrum biradiatum*, whose frond is normally composed of sixteen cells; whilst at A is figured a form which is designated as *P. tetras*, but which may be strongly sus-

FIG. 162

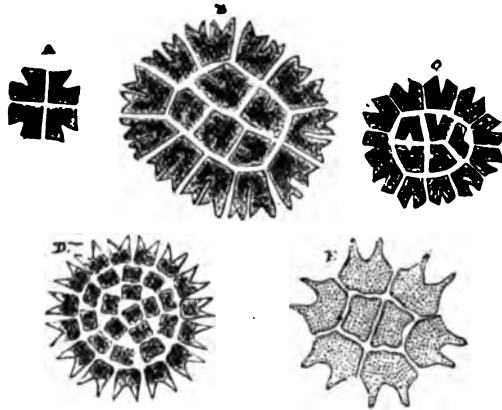

Various species (?) of *Pediastrum*.—A, *P. tetras*; B, C, *P. biradiatum*; D, *P. pertusum*; E, empty frond of *P. granulatum*.

pected to be merely a four-celled variety of B and C. Many similar cases might be cited; and the Author would strongly urge those Microscopists who have the requisite time and opportunities to apply themselves to the determination of the *real species* of these groups, by studying the entire life-history of whatever forms may happen to lie within their reach, and noting all the varieties which present themselves among the offsets from any one stock. The characters of such varieties are diffused by the process of binary subdivision amongst vast multitudes of so-called individuals. Thus it happens that, as Mr. Ralfs has remarked, "one pool may abound with individuals of *Staurastrum dejectum* or *Arthrodesmus incus*, having the mucro curved outwards; in a neighboring pool, every specimen may have it curved inwards; and in another it may be straight. The cause of the similarity in each pool no doubt is, that all its plants are offsets from a few primary fronds." Hence the universality of any particular character, in all the specimens of one gathering, is by no means sufficient to entitle these to take rank as a distinct species; since

they are, properly speaking, but repetitions of the same variety by a process of simple multiplication, really representing in their entire aggregate the one plant or tree that grows from a single seed.

272. DIATOMACEÆ.—These, like the Desmidiaceæ, are *simple cells*, having a firm external coating, within which is included an 'endochrome' whose superficial layer constitutes a 'primordial utricle:' but their external coat is consolidated by *silex*, the presence of which is one of the most distinctive characters of the group, and gives rise to the peculiar surface-markings of its members (§ 277). It has been thought by some that the solidifying mineral forms a distinct layer exuded from the exterior of the cellulose-wall; but there seems good reason for regarding that wall as itself interpenetrated by the *silex*, since a membrane bearing the characteristic surface-markings is found to remain after its removal by hydrofluoric acid. The 'endochrome' of Diatoms consists, as in other plants, of a viscid protoplasm, in which float the granules of coloring matter. In the ordinary condition of the cell, these granules are diffused through it with tolerable uniformity, except in the central spot, which is occupied by a *nucleus*; round this nucleus they commonly form a ring, from which radiating lines of granules may be seen to diverge into the cell cavity. Instead of being bright green, however, the endochrome is of a yellowish-brown. The principal coloring substance appears to be a modification of ordinary chlorophyll; it takes a green or greenish-blue tint with sulphuric acid, and often assumes this hue in drying; but with it is combined in greater or less proportion a yellow coloring matter termed *phycozanthin*, which is very unstable in the light, and fades in drying.<sup>1</sup> At certain times, oil-globules are observable in the protoplasm; these seem to represent the starch-granules of the Desmidiaceæ (§ 261) and the oil-globules of other Protophytes (§ 229). A distinct movement of the granular particles of the endochrome, closely resembling the cyclosis of the Desmidiaceæ (§ 262), has been noticed by Prof. W. Smith<sup>2</sup> in some of the larger species of Diatomaceæ, such as *Surirella biseriata*, *Nitzschia scalaris*, and *Campylodiscus spiralis*; and by Prof. Max Schultze<sup>3</sup> in *Coscinodiscus*, *Denticella*, and *Rhizosolenia*; but this movement has not the regularity so remarkable in the preceding group.

273. The *Diatomaceæ* seem to have received their name from the readiness with which those forms that grow in coherent masses (which were those with which Naturalists first became acquainted) may be *cut* or *broken through*; hence they have been also designated by the vernacular term 'brittle-worts.' Of this we have an example in the common *Diatoma* (Fig. 173), whose component cells (which in this tribe are

<sup>1</sup> A full account by M. Petit of recent Chemical and Spectroscopic investigations on the endochrome of Diatoms, will be found in "Journ. of Roy. Microsc. Soc.," Vol. iii. (1880), p. 680.

<sup>2</sup> The account of the *Diatomaceæ* here given, is chiefly based on the valuable "Synopsis of the British Diatomaceæ," by the late Prof. W. Smith; of which, and of its beautiful illustrations by Mr. Tuffen West, the Author has been enabled to make free use by the liberality of Messrs. Beck. In the sketch he has given of the Systematic arrangement of the group, however, he has followed the Classification of Mr. Ralfs (Pritchard's "Infusoria," 4th edition). A more recent Classification proposed by M. Paul Petit will be found in the "Monthly Journal of the Microscopical Society," Vol. xviii. (1877), pp. 10, 65. The new Monograph of the group by Prof. Hamilton Smith (U.S.), announced as forthcoming, will doubtless supersede all previous descriptions of it.

<sup>3</sup> "Quart. Journ. of Microsc. Science," Vol. vii. (1859), p. 13.

usually designated as *frustules*) are sometimes found adherent side by side (as at *b*) so as to form filaments, but are more commonly met with in a state of partial separation, remaining connected at their angles only (usually the *alternate* angles of the contiguous frustules) so as to form a zigzag chain. A similar cohesion at the angles is seen in the allied genus *Grammatophora* (Fig. 174), in *Isthmia* (Fig. 181), and in many other Diatoms; in *Biddulphia* (Fig. 167) there even seems to be a special organ of attachment at these points. In some Diatoms, however, the frustules produced by successive acts of binary subdivision habitually remain coherent one to another, and thus are produced filaments or clusters of various shapes. Thus it is obvious that when each frustule is a short cylinder, an aggregation of such cylinders, end to end, must form a rounded filament, as in *Melosira* (Figs. 177, 178); and whatever may be the form of the sides of the frustules, if they be parallel one to the other, a *straight* filament will be produced, as in *Achnanthes* (Fig. 185). But if, instead of being parallel, the sides be somewhat inclined towards each other, a *curved* band will be the result; this may not continue entire, but may so divide itself as to form fan-shaped expansions, as those of *Lichmophora flabellata* (Fig. 172); or the cohesion may be sufficient to occasion the band to wind itself (as it were) round a central axis, and thus to form, not merely a complete circle, but a spiral of several turns, as in *Meridion circulare* (Fig. 170). Many Diatoms, again, possess a *stipes*, or stalk-like appendage, by which aggregations of frustules are attached to other plants, or to stones, pieces of wood, etc.; and this may be a simple foot-like appendage, as in *Achnanthes longipes* (Fig. 185), or it may be a composite plant-like structure, as in *Lichmophora* (Fig. 172), *Gomphonema* (Fig. 186), and *Mastogloia* (Fig. 189). Little is known respecting the nature of this stipes; it is, however, quite flexible, and may be conceived to be an extension of the cellulose coat unconsolidated by silex, analogous to the prolongations which have been seen in the *Desmidiaceæ* (§ 261), and to the filaments which sometimes connect the cells of the *Palmellaceæ* (§ 243). Some Diatoms, again, have a mucous or gelatinous investment, which may even be so substantial that their frustules lie—as it were—in a bed of it, as in *Mastogloia* (Figs. 189 B, 190), or may form a sort of tubular sheath to them, as in *Schizonema* (Fig. 188). In a large proportion of the group, however, the frustules are always met with entirely *free*; neither remaining in the least degree coherent one to another after the process of binary subdivision has once been completed, nor being in any way connected either by a stipes or by a gelatinous investment. This is the case, for example, with *Triceratium* (Fig. 164), *Pleurosigma* (Fig. 165), *Actinocyclus* (Fig. 191, *b, b*), *Actinoptychus* (Fig. 180), *Arachnoidiscus* (Plate XI.), *Campylodiscus* (Fig. 176), *Surirella* (Fig. 175), *Coscinodiscus* (Fig. 191, *a, a*), *Heliopelta* (Plate I., Fig. 3), and many others. The solitary discoidal forms, however, when obtained in their living state, are commonly found cohering to the surface of Seaweeds.

274. We have now to examine more minutely into the curious structure of the silicified casing which incloses every Diatom-cell or 'frustule,' and the presence of which imparts a peculiar interest to the group; not merely on account of the elaborately-marked pattern which it often exhibits (Fig. 277), but also through the perpetuation of the minutest details of that pattern in the specimens obtained from fossilized deposits (Fig. 299). This casing consists of two *valves* or plates, usually of the most perfect symmetry, closely applied to each other, like the two valves.



of a Pecten, or other bivalve shell, along a line of junction or *suture*; and as each valve is more or less concavo-convex, a cavity is left between the two, which is occupied by the cell-contents. The form of this cavity, however, varies widely in different Diatoms; for sometimes each valve is hemispherical, so that the cavity is globular; sometimes it is a smaller segment of a sphere resembling a watch-glass, so that the cavity is lenticular; sometimes the central portion is completely flattened and the sides abruptly turned-up, so that the valve resembles the cover of a pill-box, in which case the cavity will be cylindrical; and these and other varieties may co-exist with any modifications of the contour of the valves, which may be square, triangular (Fig. 164), heart-shaped (Fig. 176), boat-shaped (Fig. 175, A), or very much elongated (Fig. 171), and may be furnished (though this is rare among Diatoms) with projecting out-growths (Figs. 182, 183). Hence the shape presented by the frustule differs completely with the aspect under which it is seen. In all instances, the frustule is considered to present its 'front' view when its suture is turned towards the eye, as in Fig. 175, B, C; whilst its 'side' view is seen when the centre of either valve is directly beneath the eye (A). Although the two valves meet along the suture in those newly-formed frustules which have been just produced by binary subdivision (as shown in Fig. 167, A, e), yet as soon as they begin to undergo any increase, the valves separate from one another; and by the silicification of the cell-membrane thus left exposed, a pair of *hoops* is formed, each of which is attached by one edge to the adjacent valve, while the other edge is free. As will be presently explained, one of the valves is always older than the other; and the hoop of the older valve partly incloses that of the younger, just as the cover of a pill-box surrounds the upper part of the box itself.<sup>1</sup> As the newly-formed cell increases in length, separating the valves from one another, both hoops increase in breadth by additions to their free edges; and the outer hoop slides off the inner one, until there is often but a very small 'overlap.' As growth and self-division are continually going on when the frustules are in a healthy vigorous condition, it is rare to find a specimen in which the valves are not in some degree separated by the interposition of the hoops.

275. The impermeability of the silicified casing renders necessary some special aperture, through which the surrounding water may come into relation with the contents of the cell. Such apertures are found along the whole line of suture in disk-like frustules; but when the Diatom is of an elongated form, they are found at the extremities of the frustules only. They do not appear to be absolute perforations in the envelope, but are merely points at which its siliceous impregnation is wanting; and these are usually indicated by slight depressions of its

<sup>1</sup> This was long since pointed out by Dr. Wallich in his important Memoir on the 'Development and Structure of the Diatom-valve' ("Transact. of Microsc. Soc.," N.S., Vol. viii., 1860, p. 129); but his observation seems not to have attracted the notice of Diatomists, until in 1877 he called attention to it in a more explicit manner ("Monthly Microsc. Journ.," Vol. xvii., p. 61). The correctness of his statement has been confirmed by the distinguished American Diatomist, Prof. W. Hamilton Smith; but as it has been called in question by Mr. J. D. Cox ("American Journal of Microscopy," Vol. iii., 1878, p. 100), who asserts that in *Isthmia* there are three hoops—two attached to the two valves, and the third overlapping them both at their line of junction,—the Author has himself made a very careful examination of a large series of specimens of *Isthmia* and *Biddulphia*, the result of which has fully satisfied him of the correctness of Dr. Wallich's original description.

surface. In some Diatoms, as *Surirella* (Fig. 175) and *Campylodiscus* (Fig. 176), these interruptions are connected with what were thought, by Prof. W. Smith, to be minute canals hollowed out between the silicified casing and the membrane investing the endochrome; but the apparent canals are really internal ribs, or projections of the shell, showing its characteristic 'beaded' structure under sufficiently good objectives.—In many genera the surface of each valve is distinguished by the presence of a longitudinal band on which the usual markings are deficient, and this is widened into small expansions at the extremities, and sometimes at the centre also, as we see in *Pleurosigma* (Fig. 164) and *Gomphonema* (Fig. 186); but this band is merely a portion in which the silicified casing is thicker than it is elsewhere, forming a sort of rib that gives firmness to the valve, its expansions being solid *nodules* of the same substance.—These nodules were mistaken by Prof. Ehrenberg for *apertures*; and in this error he has been followed by Kützing. There cannot any longer, however, be a doubt as to their real nature.

276. The nature of the delicate and regular markings with which probably every Diatomaceous valve is beset, has been of late years a subject of much discussion among Microscopists; but on certain points there is now a general convergence of opinion.—There can be no longer any question as to the nature of the comparatively coarse areolation seen in the larger forms, such as *Isthmia* (Fig. 163), *Triceratium* (Fig. 164), and *Biddulphia* (Fig. 167); in all of which that structure can be distinctly seen under a low magnifying power and with ordinary light. In

FIG. 163.

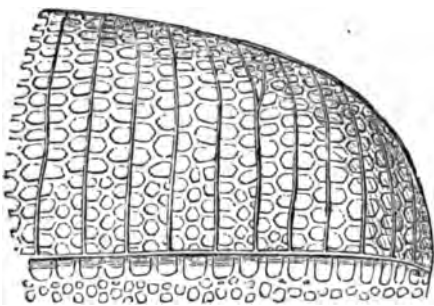

Portion of valve of *Isthmia nervosa*, highly magnified, as usually seen.

each of these instances, we see a number of symmetrically disposed *areolæ*, rounded, oval, or hexagonal, with intervening boundaries; and these have now been unmistakably proved to be *depressions*, lying in the interspaces of an elevated reticulation. The reticulation presents itself in clear *relief*, when viewed Binocularly with a sufficiently high power; and the depression of its interspaces becomes manifest when an *edge-view* is obtained of a curved surface, such as that of a valve of *Isthmia*.<sup>1</sup>—Both the depressed areolæ and the intervening network of Diatoms presenting this areolation, when examined with a sufficient magnifying power, show the 'beaded' aspect characteristically displayed in *Pleurosigma angulatum* (Fig. 166); and this is also well seen in some species of *Actinocyclus* and *Coscinodiscus*, and in the beautiful *Heliopelta* (Plate I, Fig. 3).—The observations of Mr. Stephenson on *Coscinodiscus oculus Iridis* (§

<sup>1</sup> When specimens of Diatoms which exhibit this areolation are examined by the test of Focal adjustment (§ 152), it is found that if they are mounted in Canada balsam, the optical effects are reversed; the areolæ being made to look *bright* (like elevations) when the distance of the objective is increased, and *dark* when it is diminished. This, however, is readily explicable by the fact that the refractive power of the Balsam is greater than that of the Silicified valve; so that the predominant effect will be produced by the convexities formed in the medium by the concavities of the object. (See Schultze in "Quart. Journ. of Microsc. Science," Vol. iii., N.S., 1868, p. 131.)



289), and of Mr. Shadbolt on *Arachnoidiscus* (§ 291) leave no doubt that in those Diatoms the silicified valve is composed of two layers; and the same is probably the case in all those forms which present a surface-areolation. Appearances are seen, too, in other Diatoms, which seems to indicate that in them also the valve consists of two layers.<sup>1</sup>

277. The 'beaded' aspect (Fig. 166, A), which is generally, if not universally, discernible in the silicified envelopes of *Diatoms*, when examined under a sufficiently high magnifying power, and with an illumination specially adapted to display them, is now usually regarded as indicating that the silicified envelope is composed of globular particles of silex, closely set together in regular rows.<sup>2</sup> And on this view of their nature, it is on the dimensions of their component spherules, and on the mode in which they are disposed, that those peculiar markings of certain Diatom-valves depend, which render them of special value as Test-objects (§ 161). Such valves have been commonly spoken of as marked by *striae*, longitudinal, transverse, or oblique, as the case may be; but this term does not express the real nature of the markings (the apparent *lines* being resolvable by Objectives of sufficient magnifying power and angular aperture into *rows of dots*), and should only be used for the sake of con-

(Fig. 164.



*Triceratium favus*.—A, side view; n, front view.

cisely indicating the degree of their approximation. If we examine *Pleurosigma angulatum*, one of the easier tests, with an Objective of 1-4th inch focus (having an angular aperture of 90° and a magnifying

<sup>1</sup> See Mr. C. Stodder (of Boston, U. S.), "On the Structure of the Valve of the *Diatomaceae*," in "Quart. Journ. of Microsc. Science," Vol. iii., N.S. (1863), p. 214; also Ralfs, *Op. cit.*, Vol. vi. (1858), p. 214; and Rylands, *Op. cit.*, Vol. viii. (1860), p. 27.

<sup>2</sup> See Dr. Wallich's Papers on this subject in "Quart. Journ. of Microsc. Science," Vol. vi. (1858), p. 247; "Annals of Nat. Hist.," Vol. v. Ser., 4 (Feb., 1860), p. 122; and "Trans. of Microsc. Soc.," Vol. viii., N.S. (1860), p. 129. See also Norman in "Quart. Journ. of Microsc. Sci.," Vol. ii., N.S. (1863), p. 212.—Mr. Wenham, who at one time inclined to the opposite belief, stated (when Dr. Wallich's Paper was read before the Microscopical Society), as the result of observations made with an Objective of 1-50th inch focus and large aperture, that the valves are composed wholly of spherical particles of silex, possessing high refractive power; and he showed how all the various optical appearances presented by the different species could be reconciled with the supposition that their structure is universally the same.—Recourse has been had, with a certain measure of success, to the production of 'artificial Diatoms' by the deposit of silex from its fluoride; thin films being formed, which exhibit a 'beaded' structure, often arranged in very regular patterns. See the Memoir of Prof. Max Schultze, abstracted in "Quart. Journ. of Microsc. Sci., N.S., Vol. iii. (1863), p. 120; and Mr. Slack's Paper in "Monthly Microsc. Journ.," Vol. iv. (1870), p. 181.



power of 500 diameters), we shall see very much what is represented in Fig. 165, E; namely, a double series of somewhat interrupted lines, crossing each other at an angle of 60 degrees, so as to have between them imperfectly-defined lozenge-shaped spaces. When, however, the valve is examined with an Objective of higher power, having an angular aperture

FIG. 165.

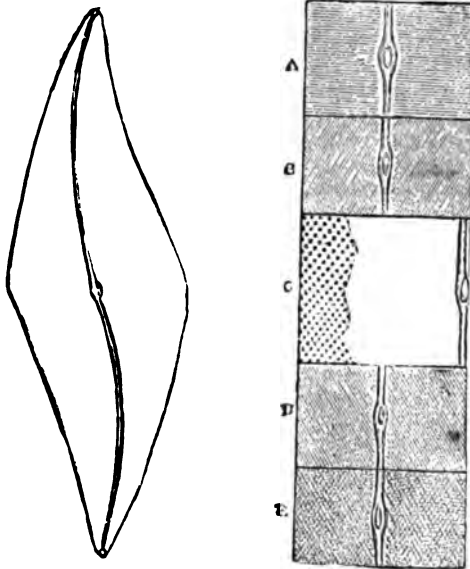

Outline of *Pleurosigma quadratum*, as seen under a power of 400 diameters:—at A, B, D, are shown the directions of the lines seen under a power of 1,300, the illuminating rays falling obliquely (in each case) in a direction at right angles to the lines; at E are shown two sets of lines, as seen when the oblique rays fall in the direction of the midrib; and at C is shown the appearance of the markings when illuminated with an Achromatic Condenser of large angular aperture, the spherules being within the focus, and the portion left blank showing the obliteration of the markings by moisture.

of 120° or more, and a magnifying power of 1,200 diameters, an appearance like that represented in Fig. 166, A) may be obtained, namely, a hexagonal areolation, in which the areolæ can be made to appear light, and the dividing network dark, or *vice versa*, according to the adjustment of the focus (Fig. 115). That the areolæ are here *elevations*, and not (like those of *Triceratium*) *depressions*, is indicated by the comparative results of the examination of fractured valves. For in *Triceratium* the fractures pass through the apparent depressions, and coincide with various optical indications in establishing their reality. Fractured valves of *P. angulatum* and allied species show that the weakest parts are *between* the bead-rows; and single beads may often be seen terminating a sharp angular portion. Further, when specimens of *Pleurosigma* mounted beneath glass have had their markings obscured by moisture, the obscurity is dissipated by the application of a gentle heat, in a way that is readily explicable on the supposition that the markings are elevations, but seems unintelligible on the idea of their being depressions.<sup>1</sup>—Notwithstanding these considerations, however, it must be freely admitted that there is still considerable uncertainty respecting the real structure of the Diatom-valve. For it cannot be positively asserted that the focal adjustment which gives the image represented in Fig. 166, A, is more correct than that which gives the equally distinct images B, C, D of other parts of the same valve, of which the last departs in the most marked manner from what is commonly regarded as the normal type. And now that it has been shown that these images are not formed dioptrically, but are resultants of the combination of numerous 'diffraction-spectra' (§ 157), it is impossible to entertain the same confidence as before that they truly *picture* the surface marking they are supposed to

<sup>1</sup> See Mr. G. Hunt in "Quart. Journ. of Microsc. Sci.," Vol. iii. (1855), p. 174.

represent.—By Mr. Stephenson, who has made a special study of the effects of the immersion of Diatom-valves in very highly-refracting media, it is believed that the light spaces really represent apertures (§ 289). The question must be regarded, therefore, as still an open one.

278. Multiplication by Binary subdivision takes place among the *Diatomaceæ* on the same general plan as in the *Desmidiaceæ*, but with some modifications incident to the peculiarities of the structure of the former group.—The first stage consists in the elongation of the cell, and the formation of a 'hoop' adherent to each end-valve (§ 274), so that the two valves are separated by a band, which progressively increases in breadth by addition to the free edges of the hoops, as is well seen in Fig. 167 A. In the newly formed cell *e*, the two valves are in immediate ap-

FIG. 166.

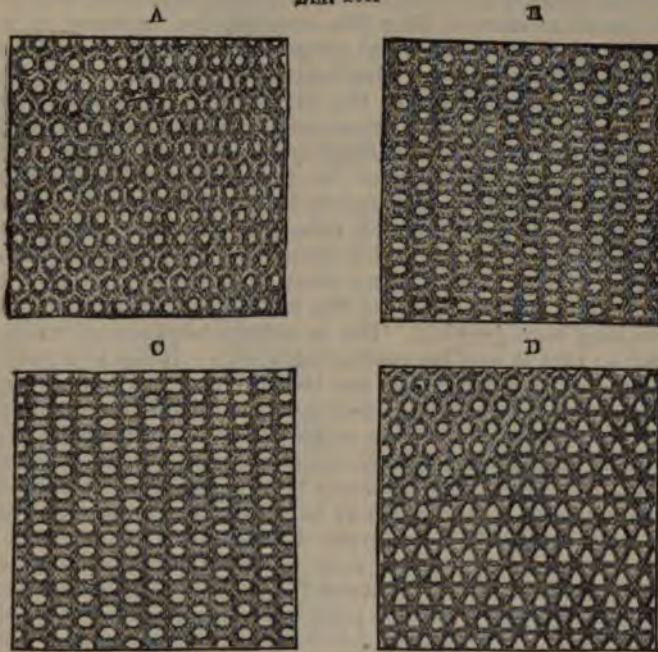

Portions of Valve of *Pleurosigma angulatum*, as seen under a magnifying power of 2,000 diameters, with central illumination; from a Photograph by Carl Günther in the possession of the Royal Microscopical Society.

A. Normal hexagonal areolation; areolæ bright circles, surrounded by dark hexagons.

B. In upper part, areolæ and their dark borders graduating from circular to elliptical; in lower part, dark borders coalescing latterly, so as to give the appearance of continuous vertical lineation.

C. Areolæ larger, brighter, and more elliptical; their dark bodies coalescing laterally, so as to form very decided vertical lineation.

D. Transition from hexagonal to triangular areolation, with three series of dark lines, one horizontal and two oblique.

position; in *d*, a band intervenes; in *a*, this band has become much wider; and in *b*, the increase has gone on until the original form of the cell is completely changed. At the same time, the endochrome separates into two halves; the nucleus also subdivides in the manner formerly shown (Plate VIII., fig. 1, G, H, I); and the primordial utricle folds-in, first forming a mere constriction, then an hour-glass contraction, and



finally a complete double partition, as in other instances (§ 252). From each of its adjacent surfaces a new siliceous valve is formed, as shown at Fig. 167, A, c, just as a new cellulose-wall is generated in the subdivision of other cells; and this valve is usually the exact counterpart of the one to which it is opposed, and forms with it a complete cell, so that the original frustule is replaced by two frustules, each of which has one old and one new valve, just as in Desmidiaceæ (§ 264). Generally speaking, the new valves are a little smaller than their predecessors; so that after repeated subdivisions (as in chains of *Isthmia*), a diminution of diameter becomes obvious. But sometimes the new valves are a little larger than their predecessors; so that, in the filamentous species, there may be an increase sufficient to occasion a gradual widening of the filament, although not perceptible when two contiguous frustules are compared; whilst, in the free forms, frustules of different sizes may be met with, of which the larger are more numerous than the smaller, the increase in number having taken place in geometrical progression, whilst that of size was uniform. It is not always clear what becomes of the 'hoop.' In *Melosira* (Figs. 177, 178), and perhaps in the filamentous species generally, the 'hoops' appear to keep the new frustules united together for some time. This is at first the case also in *Biddulphia* and *Isthmia* (Fig. 181), in which the continued connection of the two frustules by its means give rise to an appearance of two complete frustules having been developed within the original (Fig. 167, A, c); subsequently, however, the two new frustules slip out of the hoop, which then becomes completely detached. The same thing happens with many other Diatoms, so that the 'hoops' are to be found in large numbers in the settlings of water in which these plants have long been growing. But in some other cases all trace of the hoop is lost; so that it may be questioned whether it has ever been properly silicified, and whether it does not become fused (as it were) into the gelatinous envelope.—During the healthy life of the Diatom, the process of self-division is continually being repeated; and a very rapid multiplication of frustules thus takes place, all of which (as in the cases already cited, §§ 229, 271), must be considered to be repetitions of one and the same individual form. Hence it may happen that myriads of frustules may be found in one locality, uniformly distinguished by some peculiarity of form, size, or marking; which may yet have had the same remote origin as another collection of frustules found in some different locality, and alike distinguished by some peculiarity of its own. For there is strong reason to believe that such differences spring-up among the progeny of any true *generative* act (§ 229); and that when that progeny is dispersed by currents into different localities, each will continue to multiply its own special type so long as the process of self-division goes on.

279. It is uncertain whether the Diatomaceæ also multiply by the breaking-up of their endochrome into segments, and by the liberation of these, either in the active condition of 'zoöspores,' or in the state of 'still' or 'resting' spores. Certain observations by Focke,<sup>1</sup> however, taken in connection with the analogy of other Protophytes, and with the fact that the zygospore-frustules almost certainly thus multiply by gonidia (§ 280), seem to justify the conclusion that such a method of multiplication does obtain in this group. And it is not at all unlikely that very considerable differences in the size, form, and markings of the frustules, such as many consider sufficient to establish a diversity of species, have their origin in

<sup>1</sup> "Physiologisch. Studien," Heft ii., 1853.



this mode of propagation. It seems probable that, so long as the vegetating processes are in full activity, multiplication takes place in preference by self-division; and that it is when deficiency of warmth, of moisture, or of some other condition, gives a check to these, that the formation of encysted 'gonidia,' having a greater power of resisting unfavorable influences, will take place; whereby the species is maintained in a dormant state until the external conditions favor a renewal of active vegetation (§ 234).

280. Conjugation, so far as is at present known, takes place among the ordinary Diatomaceæ almost exactly as among the Desmidiaceæ; except that it sometimes results in the production of two 'zygospores,' instead of a single one. Thus in *Surirella* (Fig. 175), the valves of two

FIG. 167.

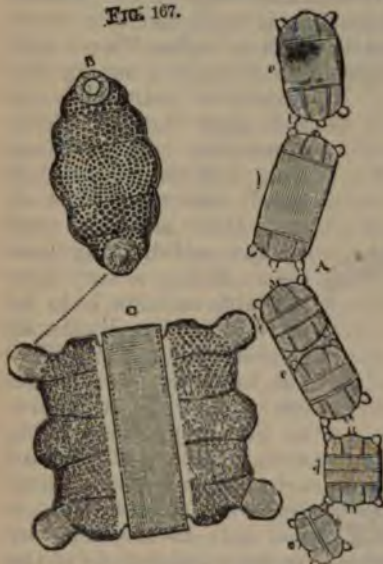

*Biddulphia pulchella*:—A, chain of cells in different states; a, full size; b, elongation preparatory to subdivision; c, formation of two new cells; d, e, young cells;—a, end-view;—c, side-view of a cell more highly magnified.

FIG. 168.

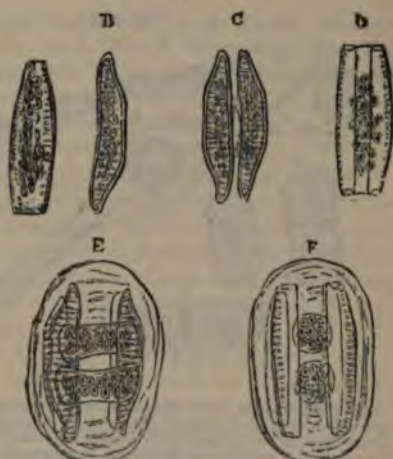

Conjugation of *Epithemia turgida*:—A, front view of single frustule; b, side view of the same; c, two frustules with their concave surfaces in close apposition; d, front view of one of the frustules showing the separation of its valves along the suture; E, F, side and front views after the formation of the zygospores.

free and adjacent frustules separate from each other at the sutures, and the two endochromes (probably included in their primordial utricles) are discharged; these coalesce to form a single mass, which becomes inclosed in a gelatinous envelope; and in due time this 'zygospore' shapes itself into a frustule resembling that of its parent, but of larger size. But in *Epithemia* (Fig 168, A, B)—the first Diatom in which the conjugating process was observed by Mr. Thwaites<sup>1</sup>—the endochrome of each of the conjugating frustules (C, D) appears to divide at the time of its discharge into two halves; each half coalesces with half of the other endochrome; and thus two 'zygospores' (E, F) are formed, which, as in the preceding case, become invested with a gelatinous envelope, and gradually assume

<sup>1</sup> See "Annals of Natural History," Ser. 1, Vol. xx. (1847), pp. 9, 343; and Ser. 2, Vol. i. (1848), p. 161.

the form and markings of the parent-frustules, but grow to a very much larger size, the sporangial masses having obviously a power of self-increase up to the time when their envelopes are consolidated. It seems to be in this way that the normal size is recovered, after the progressive diminution which is incident to repeated binary multiplication (§ 278). Of the subsequent history of the 'zygospores' much remains to be learned; and it may not be the same in all cases. Appearances have been seen which make it almost certain that the contents of each zygospore break-up into a brood of *gonidia*, and that it is from these that the new generation originates. These gonidia, if each be surrounded (as in many other cases) by a distinct cyst, may remain undeveloped for a considerable period; and they must augment considerably in size before they obtain the dimensions of the parent frustule.—It is in this stage of the process that the modifying influence of external agencies is most likely to exert its effects; and it may be easily conceived that (as in higher Plants and Animals) this influence may give rise to various diversities among the

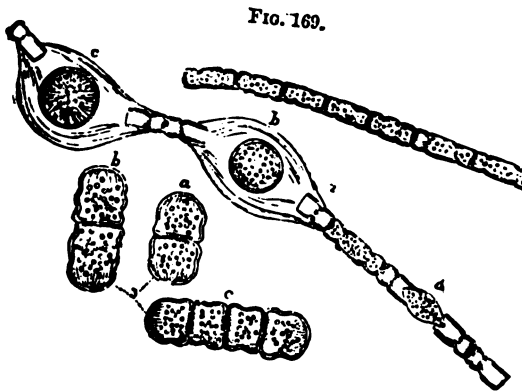

FIG. 169.  
Self-Conjugation (1) of *Melosira Italica* (*Aulacoseira crenulata*, Thwaites):—1, simple filament; 2, filament developing auxospores; a, b, c, successive stages in the formation of auxospores; 3, auxospore-frustules, in successive stages, a, b, c, of multiplication.

respective individuals of the same brood; which diversities, as we have seen, will be transmitted to all the repetitions of each that are produced by the self-dividing process. Hence a very considerable latitude is to be allowed to the limits of Species, when the different forms of Diatomaceæ are compared; and here, as in many other cases, a most important question arises to what *are* those limits—a question which can only be answered by such a careful study of the entire life-history of every

single type, as may advantageously occupy the attention of many a Microscopist who is at present devoting himself to the resolution of the markings on Diatom-valves, and to the multiplication of reputed species by the detection of minute differences.<sup>1</sup>

281. This formation of what are termed 'auxospores'—as serving to augment the size of the cells which are to give origin to a new generation—takes place on a very different plan in some of those filamentous types, such as *Melosira* (Figs. 177, 178), in which a strange inequality presents itself in the diameters of the different cells of the same filaments, the larger ones being usually in various stages of binary subdivision, by which they multiply themselves longitudinally. According to the observations of Mr. Thwaites (*loc. cit.*), these also are the products of a kind

<sup>1</sup> See on this subject a valuable Paper by Prof. W. Smith 'On the Determination of Species in the Diatomaceæ,' in the "Quart. Journ. of Microsc. Science," Vol. iii. (1855), p. 130; a Memoir Prof. W. Gregory 'On Shape of Outline as a specific character of Diatomaceæ,' in "Trans. of Microsc. Soc.," 2d Series, Vol. iii. (1855), p. 10; and the Author's Presidential Address in the same volume, pp. 44-50.



of conjugation between the adjacent cells of the ordinary diameter; taking place before the completion of their separation. He describes the endochrome of particular frustules, after separating as if for the formation of a pair of new cells, as moving back from the extremities towards the centre, rapidly increasing in quantity, and aggregating into a zygospore (Fig. 169, 2, *a, b, c*): around this a new envelope is developed, which may or may not resemble that of the ordinary frustules, but which remains in continuity with them; and this zygospore soon undergoes binary subdivision (3, *a, b, c*), the cells of the new series thus developed presenting the character of those of the original filament (1), but greatly exceeding them in size. From what has been already stated (§ 278), it seems probable that a gradual reversion to the smaller form takes place in subsequent subdivisions; a further reduction being checked by a new formation of zygospores. Whether this formation partakes of the character of 'conjugation' (as supposed by Mr. Thwaites) is still doubtful; some later observers regarding 'auxospores' as simply enlarged forms of single cells.

282. Most of the Diatoms which are not fixed by a stipes, possess some power of spontaneous movement; and this is especially seen in those whose frustules are of a long narrow form, such as that of the *Navicula* generally. The motion is of a peculiar kind, being usually a series of jerks, which carry forward the frustule in the direction of its length, and then carry it back through nearly the same path. Sometimes, however, the motion is smooth and equable; and this is especially the case with the curious *Bacillaria paradoxa* (Fig. 171), whose frustules slide over each other in one direction until they are all but detached, and then slide as far in the opposite direction, repeating this alternate movement at very regular intervals.<sup>1</sup> In either case the motion is obviously quite of a different nature from that of beings possessed of a power of self-direction. "An obstacle in the path," says Prof. W. Smith, "is not avoided, but pushed aside; or, if it be sufficient to avert the onward course of the frustule, the latter is detained for a time equal to that which it would have occupied in its forward progression, and then retires from the impediment as if it had accomplished its full course." The character of the movement is obviously similar to that of those motile forms of Protophyta which have been already described; but it has not yet been definitely traced to any organ of impulsion; and the cause of it is still obscure. By Prof. W. Smith it is referred to forces operating within the frustule, and originating in the vital operations of growth, etc., which may cause the surrounding fluid to be drawn in through one set of apertures, and expelled through the other.<sup>2</sup> "If," as he remarks, "the motion be produced by the exosmose taking place alternatively at one and the other extremity, while endosmose is proceeding at the other, an alternating movement would be the result in frustules of a linear form; whilst in others of an elliptical or orbicular

<sup>1</sup> This curious phenomenon the Author has himself repeatedly had the opportunity of witnessing.

<sup>2</sup> It has been objected to this view, by the Authors of the "Micrographic Dictionary," that, if such were the case, the like movements would be frequently met with in other minute unicellular organisms. But there are no other such organisms in which the cell is almost entirely inclosed in an impermeable envelope, so that the imbibition and expulsion of fluid are limited to a small number of definite points, instead of being allowed to take place equally (as in other unicellular organisms) over the entire surface.—See Mereschkowski in "Journ. Roy. Microsc. Soc.," Ser. 2, Vol. i. (1881), p. 102.



outline, in which foramina exist along the entire line of suture, the movements, if any, must be irregular or slowly lateral. Such is precisely the case. The backward and forward movements of the *Navicula* have been already described; in *Surirella* (Fig. 175) and *Campylodiscus* (Fig. 176), the motion never proceeds further than a languid roll from one side to the other; and in *Gomphonema* (Fig. 187), in which a foramen fulfilling the nutritive office is found at the larger extremity only, the movement (which is only seen when the frustule is separated from its stipes) is hardly a perceptible advance in intermitted jerks in the direction of the narrow end.<sup>1</sup>

283. The principles upon which this interesting group should be classified, cannot be properly determined, until the history of the Generative process—of which nothing whatever is yet known in a large proportion of Diatoms, and very little in any of them—shall have been thoroughly followed out. The observations of Focke<sup>2</sup> render it highly probable that many of the forms at present considered as distinct from each other, would prove to be but different states of the same, if their *whole* history were ascertained. On the other hand, it is by no means impossible that some which appear to be nearly related in the structure of their frustules and in their mode of growth, may prove to have quite different modes of reproduction. At present, therefore, *any* classification must be merely provisional; and in the notice now to be taken of some of the most interesting forms of *Diatomaceæ*, the method of Prof. Kützing, which is based upon the characters of the individual frustules, is followed in preference to that of Prof. W. Smith, which was founded on the degree of connection remaining between the several frustules after self-division.<sup>3</sup>—In each Family the frustules may exist under four conditions, (*a*) free, the self-division being entire, so that the frustules separate as soon as the process has been completed; (*b*) stipitate, the frustules being implanted upon a common stem (Fig. 172), which keeps them in mutual connection after they have themselves undergone a complete self-division; (*c*) united in a filament, which will be continuous (Fig. 177) if the cohesion extend to the entire surfaces of the sides of the frustules, but may be a mere zigzag chain (Fig. 173) if the cohesion be limited to their angles; (*d*) aggregated into a frond (Fig. 188), which consists of numerous frustules more or less regularly inclosed in a gelatinous investment. It is not in every family, however, that these four conditions are at present known to exist; but they have been noticed in so many, that they may be fairly presumed to be capable of occurring in all.—Excluding the family *Actinisceæ* (of whose silicified skeletons we have examples in Fig. 191, *c, d*), which seem to have no adequate title to rank among Diatoms (their true alliance being apparently with the *Polycystina*), the entire group may be divided into two

<sup>1</sup> According to this observer ("Ann. of Nat. Hist.," 2d Ser., Vol. xv., 1855, p. 287), *Navicula bifrons* forms, by the spontaneous fission of its internal substance, spherical bodies which, like gemmules, give rise to *Surirella microcora*. These by conjugation produce *N. splendida*, which gives rise to *N. bifrons* by the same process. He is only able to speak positively, however, as to the production of *N. bifrons* from *N. splendida*; that of *Surirella microcora* from *N. bifrons*, and that of *N. splendida* from *Surirella microcora*, being matters of inference from the phenomena witnessed by him.

<sup>2</sup> The method of Kützing is the one followed, with some modification, by Mr. Ralfs in his revision of the group for the 4th Edition of Pritchard's "Infusoria;" and to his systematic arrangement the Author would refer such as desire more detailed information.

principal Sections; one (B) containing those forms in which the valves possess a true central nodule and median longitudinal line (as *Pleurosigma*, Fig. 165, and *Gomphonema*, Fig. 186, A); and the other (A) including all those in which the valves are destitute of a central nodule (as *Surirella*, Fig. 175, A). Among the latter, however, we find some (*b*) in which there is an umbilicus or pseudo-nodule with radiating lines or cellules, whilst there are others (*a*) which have no central marking whatever.

284. Commencing with the last-named division (A), the first Family is that of *Eunoticeæ*, of which we have already seen a characteristic example in *Epithemia turgida* (Fig. 168). The essential characters of this family consist in the more or less lunate form of the frustules in the lateral view (Fig. 168, B), and in the striæ being continuous across the valves without any interruption by a longitudinal line. In the genus *Eunotia* the frustules are free; in *Epithemia* they are very commonly adherent by the flat or concave surface of the connecting zone; and in *Himantidium* they are usually united into ribbon-like filaments.—In the

FIG. 170.

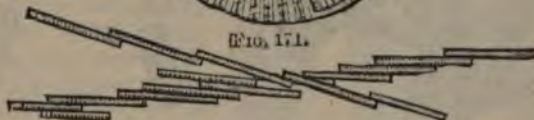

FIG. 171.

FIG. 170.—*Meridion circulare*.FIG. 171.—*Bacillaria paradoxa*.

Family *Meridiææ* we find a similar union of the transversely-striated individual frustules; but these are narrower at one end than at the other, so as to have a cuneate or wedge-like form; and are regularly disposed with their corresponding extremities always pointing in the same direction, so that the filament is curved instead of straight, as in the beautiful *Meridion circulare* (Fig. 170). Although this plant, when gathered and placed under the microscope, presents the appearance of circles overlying one another, it really grows in a helical (screw-like) form, making several continuous turns. This Diatom abounds in many localities in this country; but there is none in which it presents itself in such rich luxuriance as in the mountain-brooks about West Point in the United States, the bottoms of which, according to Prof. Bailey, "are literally covered in the first warm days of spring with a ferruginous-colored mucous matter, about a quarter of an inch thick, which, on examination by the microscope, proves to be filled with millions and millions of these exquisitely-beautiful silicious bodies. Every submerged stone, twig, and spear of grass is enveloped by them; and the waving plume-like appear-

ance of a filamentous body covered in this way is often very elegant." The frustules of *Meridion* are attached when young to a gelatinous cushion; but this disappears with the advance of age.—In the Family *Licmophoreæ* also the frustules are wedge-shaped; in some genera they have transverse markings, whilst in others these are deficient; but in most instances there are to be observed two longitudinal suture-like lines on each valve (which have received the special designation of *valve*) connecting the puncta at their two extremities. The newly-formed part of the stipes in the genus *Licmophora*, instead of itself becoming double with each act of self-division of the frustule, increases in breadth, while the frustules themselves remain coherent; so that a beautiful fan-like arrangement is produced (Fig. 172). A splitting-away of a few frustules seems occasionally to take place, from one side or the other, before the elongation of the stipes; so that the entire plant presents us with a more

FIG. 172.

*Licmophora flabellata.*

FIG. 173.

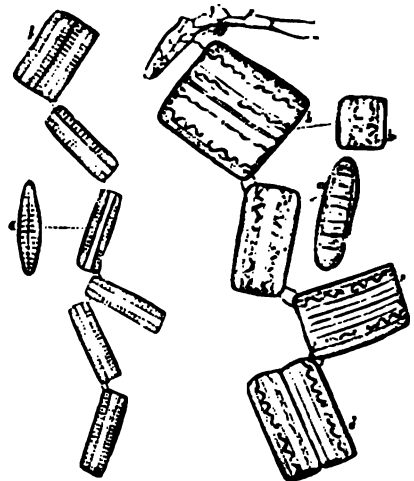

FIG. 174.

Fig. 173.—*Diatoma vulgare*:—a, side view of frustule; b, frustule undergoing self-division.  
Fig. 174.—*Grammatophora serpentina*:—a, front and side views of single frustule; b, b, front and end views of divided frustule; c, frustule about to undergo self-division; d, frustule completely divided.

or less complete *flabella* or fan upon the summit of the branches, with imperfect flabella or single frustules irregularly scattered throughout the entire length of the footstalk. This beautiful plant is marine, and is parasitic upon Seaweeds and Zoophytes.

285. In the next Family, that of *Fragillariæ*, the frustules are of the same breadth at each end, so that, if they unite into a filament, they form a straight band. In some genera they are smooth, in others transversely striated, with a central nodule; when striæ are present, they run across the valves without interruption.—To this family belongs the genus *Diatoma*, which gives its name to the entire group; that name (which means cutting through) being suggested by the curious habit of the genus, in which the frustules after self-division separate from each other along their lines of junction, but remain connected at their angles, so as to form zigzag chains (Fig. 173). The valves of *Diatoma*, when turned



sideways (*a*), are seen to be strongly marked by transverse striæ, which extend into the front view. The proportion between the length and the breadth of each valve is found to vary so considerably, that, if the extreme forms only were compared, there would seem adequate ground for regarding them as belonging to different species. The genus inhabits fresh water, preferring gently-running streams, in which it is sometimes very abundant.—The genus *Fragillaria* is nearly allied to *Diatoma*, the difference between them consisting chiefly in the mode of adhesion of the frustules, which in *Fragillaria* form long straight filaments with parallel sides: the filaments, however, as the name of the genus implies, very readily break-up into their component frustules, often separating at the slightest touch. Its various species are very common in pools and ditches.—This family is connected with the next by the genus *Nitzschia*, which is a somewhat aberrant form distinguished by the presence of a prominent keel on each valve, dividing it into two portions which are usually unequal, while the entire valve is sometimes curved, in *N. sigmoidea*, which is sometimes used as a Test-object, but is not suitable for that purpose on account of the extreme variability of its striation.—Nearly allied to this is the genus *Bacillaria*, so named from the elongated staff-like form of its frustules; its valves have a longitudinal punctated keel, and their transverse striæ are interrupted in the median line. The principal species of this genus is the *B. paradoxa*, whose remarkable movement has been already described (§ 282). Owing to this displacement of the frustules, its filaments seldom present themselves with straight parallel sides, but nearly always in forms more or less oblique, such as those represented in Fig. 171. This curious object is an inhabitant of salt or of brackish water. Many of the species formerly ranked under this genus are now referred to the genus *Diatoma*. The

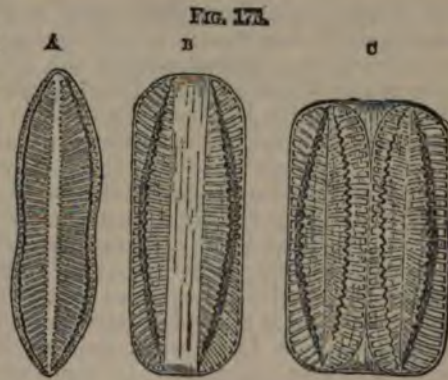

*Surirella constricta* :—A, side view; B, front view; C, binary subdivision.

Genera *Nitzschia* and *Bacillaria* are now associated by Mr. Ralfs, with some other genera which agree with them in the bacillar or staff-like form of the frustules and in the presence of a longitudinal keel, in the Sub-family *Nitzschieæ*, which ranks as a section of the *Surirellææ*.—Another Sub-family, *Synedreææ*, consists of the genus *Synedra* and its allies, in which the bacillar form is retained (Fig. 192, *l*), but the keel is wanting, and the valves are but little broader than the front of the frustule.

285. In the *Surirellææ* proper, the frustules are no longer bacillar, and the breadth of the valves is usually (though not always) greater than the front view. The distinctive character of the genus *Surirella*, in addition to the presence of the supposed 'canaliculi' (§ 275), is derived from the longitudinal line down the centre of each valve (*A*), and the

<sup>1</sup> See Pritchard's "Infusoria," 4th Ed. p. 940. The genus *Nitzschia* was in the first instance placed by Mr. Ralfs in the family *Fragillarieææ*, and the genus *Bacillaria* in the family *Surirellæææ*.

prolongation of the margins into 'alæ.' Numerous species are known, which are mostly of a somewhat ovate form, some being broader and others narrower than *S. constricta*; the greater part of them are inhabitants of fresh or brackish water, though some few are marine; and several occur in those Infusorial earths which seem to have been deposited at the bottoms of lakes, such as that of the Mourne mountains in Ireland

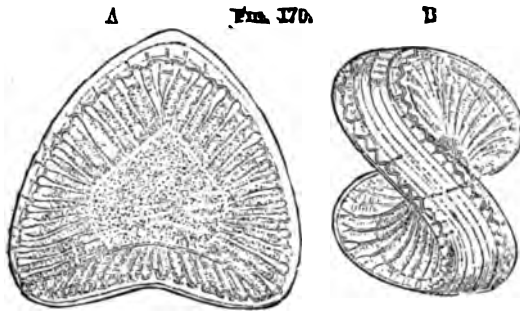

*Campylodiscus costatus*.—A, front view; B, side view

(Fig. 192, *b, c, k*).—In the genus *Campylodiscus* (Fig. 176) the valves are so greatly increased in breadth as to present almost the form of disks (A), and at the same time have more or less of a peculiar twist or saddle-shaped curvature (B). It is in this genus that the supposed 'canaliculi' are most developed, and it is consequently here that they may be best studied;

and of their being here really *costæ* or internally projecting ribs, no reasonable doubt can remain after examination of them under the Binocular microscope, especially with the 'blackground' illumination. The form of the valves in most of the species is circular or nearly so; some are nearly flat, whilst in others the twist is greater than in the species here represented. Some of the species are marine, whilst others occur in fresh water; a very beautiful form, the *C. clypeus*, exists in such abundance in the Infusorial stratum discovered by Prof. Ehrenberg at Soos near Ezer in Bohemia, that the earth seems almost entirely composed of it.

287. The next Family, *Striatelleæ*, forms a very distinct group, differentiated from every other by having longitudinal *costæ* on the connecting portions of the frustules; these *costæ* being formed by the inward projection of annular siliceous plates (which do not, however, reach to the centre), so as to form septa dividing the cavity of the cell into imperfectly-separated chambers. In some instances these annular septa are only formed during the production of the valves in the act of self-division, and on each repetition of such production being thus always *definite* in number, whilst in other cases the formation of the septa is continued after the production of the valves, and is repeated an uncertain number of times before the recurrence of a new valve-production, so that the annuli are *indefinite* in number. In the curious *Grammatophora serpentina* (Fig. 174) the septa have several undulations and incurved ends, so as to form serpentine curves, the number of which seems to vary with the length of the frustule. The lateral surfaces of the valves in *Grammatophora* are very finely striated; and some species, as *G. subtilissima* and *G. marina* are used as Test-object (§ 161). The frustules in most of the genera of this family separate into zigzag chains, as in Diatoma; but in a few instances they cohere into a filament, and still more rarely are furnished with a stipes.—The small Family *Terpsinoææ* is separated by Mr. Ralfs from the *Striatelleæ*, with which it is nearly allied in general characters, because its septa (which in the latter are nearly longitudinal and divide the central portions into chambers) are transverse and are confined to the lateral portions of the frustules,



which appear in the front view as in *Biddulphiæ* (§ 292). The typical form of this family is the *Terpsinœ musica*, so named from the resemblance which the markings of its costæ bear to musical notes.

288. We next come to two Families in which the lateral surfaces of the frustules are *circular*; so that, according to the flatness or convexity of the valves and the breadth of the intervening hooped band, the frustules may have the form either of thin disks, short cylinders, bi-convex lenses, oblate spheroids, or even of spheres. Looking at the structure of the individual frustules, the line of demarcation between these two families, *Melosireæ* and *Coscinodisceæ*, is by no means distinct; the principal difference between them being that the valves of the latter are commonly cellulated, whilst those of the former are smooth. Another important difference, however lies in this, that the frustules of the *Coscinodisceæ* are always free, whilst those of the *Melosireæ* remain coherent into filaments, which often so strongly resemble those of the simple *Confervaceæ* as to be readily distinguishable only by the effect of heat. Of these last the most important Genus is *Melosira* (Figs. 177, 178). Some of its species are marine, others fresh-water; one of the latter, the *M. ochracea*, seems to grow best in boggy pools containing a ferruginous impregnation; and it is stated by Prof. Ehrenberg to take up from the water, and to incorporate with its own substance, a considerable quantity of iron. The filaments of *Melosira* very commonly fall apart at the slightest touch: and in the Infusorial earths, in which some species abound, the frustules are always found detached (Fig. 192, *a a, d d*).

FIG. 177

*Melosira subflexilis.*

FIG. 178.

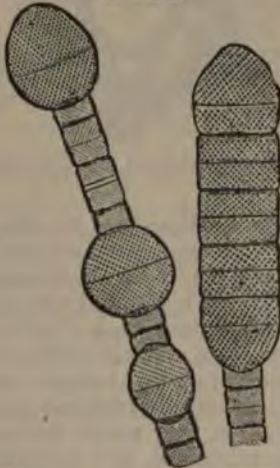
*Melosira varians.*

The meaning of the remarkable difference in the sizes and forms of the frustules of the same filaments (Figs. 177, 178) has not yet been fully ascertained (§ 281). The sides of the valves are often marked with radiating striae (Figs. 192, *d d*); and in some species they have toothed or serrated margins, by which the frustules lock-together. To this family belongs the genus *Hyalodiscus*, of which *H. subtilis* was first brought into notice by the late Prof. Bailey as a Test-object, its disk being marked, like the engine-turned back of a watch, with lines of exceeding delicacy, only visible by the highest magnifying powers and the most careful illumination.

289. The family *Coscinodisceæ* includes a large proportion of the most beautiful of those discoidal Diatoms, of which the valves do not present any considerable convexity, and are connected by a narrow zone. The genus *Coscinodiscus*, which is easily distinguished from most of the genera of this family by not having its disk divided into compartments, is of great interest from the vast abundance of its valves in certain fossil deposits (Fig. 191, *a, a, a*), especially the Infusorial earth of Richmond in Virginia, of Bermuda, and of Oman, as also in Guano. Each



frustule is of discoidal shape, being composed of two delicately undulating valves, united by a hoop; so that, if the frustules remain in adhesion, they would form a filament resembling that of *Melosira* (Fig. 178). The regularity of the hexagonal areolation shown by its valves renders them beautiful microscopic objects; in some species the areolæ are smallest near the centre, and gradually increase in size towards the margin; in others a few of the central areolæ are the largest, and the rest are of nearly uniform size; while in others, again, there are radiating lines formed by areolæ of a size different from the rest. Most of the species are either marine, or are inhabitants of brackish water; when living they are most commonly found adherent to Sea-weeds or Zoophytes; but when dead, the valves fall as a sediment to the bottom of the water. In both these conditions, they were found by Prof. J. Quekett in connection with Zoophytes which had been brought home from Melville Island by Sir E. Parry; and the species seemed to be identical with those of the Richmond earth.—The investigations of Mr. J. W. Stephenson,<sup>1</sup> on *Coscinodiscus oculus Iridis* show that the peculiar "eye-like" appearance in the centre of each of its hexagonal areola arises from the intermingling of the markings of two distinct layers, differing considerably in structure; the markings of the lower layer being partially seen through

FIG. 179

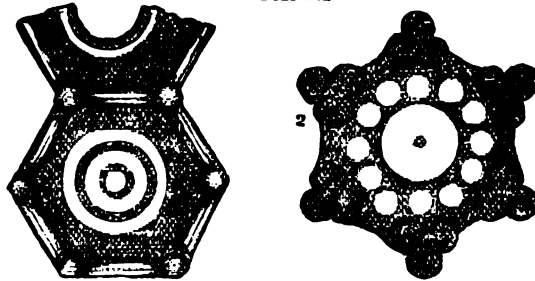

Structure of siliceous valve of *Coscinodiscus oculus Iridis*.—1. Hexagonal areola of inner or "eye-spot" layer; 2. Areola of outer layer.

those of the upper. By fracturing these Diatoms, Mr. Stephenson has succeeded in separating portions of the two layers, so that each could be examined singly. He has also mounted them in bisulphide of carbon, the refractive power of which is very high; and also in a solution of phosphorus in bisulphide of carbon, which has a still higher refractive index. If we suppose a Diatom to be marked with *convex depressions*, they would act as concave lenses in air, which is less refractive than their own silix; but when such lenses are immersed in bisulphide of carbon, or in the phosphorus solution, they would be converted into *convex lenses* of the more refractive substance, and have their action in air reversed. Analogous but opposite changes must take place, when convex Diatom-lenses are viewed first in air, and then in the more refractive media. Applying these and other tests to *Coscinodiscus oculus Iridis*, Mr. Stephenson considers both layers to be composed of hexagons, represented in Fig. 179, from drawings by Mr. Stewart. The upper layer is much stronger and thicker than the lower one; and the framework of its hexagons more readily exhibits its beaded appearance. The

<sup>1</sup> "Monthly Microscopical Journal," Vol. x. (1873), p. 1.

lower layer is nearly transparent, and little conspicuous when seen in bisulphide of carbon, except, as shown in the figure, when the framework of the hexagons, and the rings in the midst of them, appear thickened and more refractive. In both layers the balance of observations tends to the belief that the hexagons have no floors, and are in fact perforated by foramina like those of minute Polycystina. The cells formed by the hexagons of the upper layer are of considerable depth; those of the lower layer are shallower. In both layers fractured edges show the hexagon-frames to be the strongest parts; and in neither has Mr. Stephenson been able to detect any broken remnants of floors, which might be expected to be visible with high powers if they existed at all.—If further observations should confirm Mr. Stephenson's belief that *Coscinodisci* are perforated by numerous foramina, a similar structure will be sought for in other Diatoms, and the views of naturalists as to the character of the group may be materially modified. At present the chief difference in minute structure that has been recognized, may be seen by comparing the apparently simple beading of *Pleurosigma* with the hexagonal formations in *Coscinodiscus*, etc.; but a far more important divergence will have to be considered, if some Diatom-valves have a multiplicity of foramina, and others either none, or only a few at certain spots. It is very desirable that living forms of *Coscinodisci* should be carefully examined; since, if they really have foramina, some minute organs may be protruded through them.

290. The genus *Actinocyclus*<sup>1</sup> closely resembles the preceding in form, but differs in the markings of its valvular disks, which are minutely and densely punctated or cellulated, and are divided radially by single or double dotted lines, which, however, are not continuous but interrupted (Plate I., Fig. 1). The disks are generally iridescent; and, when mounted in balsam, they present various shades of brown, green, blue, purple, and red: blue or purple, however, being the most frequent. An immense number of species have been erected by Prof. Ehrenberg on minute differences presented by the rays as to number and distribution; but since scarcely two specimens can be found in which there is a perfect identity as to these particulars, it is evident that such minute differences between organisms otherwise similar are not of sufficient account to serve for the separation of species. This form is very common in guano from Ichaboe.—Allied to the preceding are the two genera *Asterolampra* and *Asteromphalus*, both of which have circular disks of which the marginal portion is minutely areolated, whilst the central area is smooth and perfectly hyaline in appearance, but is divided by lines into radial compartments which extend from the central umbilicus towards the periphery. The difference between them simply consists in this; that in *Asterolampra* all the compartments are similar and equidistant, and the rays equal (Plate I., Fig. 2); whilst in *Asteromphalus* two of the compartments are closer together than the rest, and the inclosed hyaline ray (which is distinguished as the median or basal ray) differs in form from the others, and is sometimes specially continuous with the umbilicus (Plate I., Fig. 4). The eccentricity thus produced in the other rays has been made the basis of another generic designation, *Spatangidium*; but it may be

---

<sup>1</sup> The Author concurs with Mr. Ralfs in thinking it preferable to limit the genus *Actinocyclus* to the forms originally included in it by Ehrenberg, and to restore the genus *Actinoptychus* of Ehrenberg, which had been improperly united with *Actinocyclus* by Profs. Kützinger and W. Smith.

doubted whether this is founded on a valid distinction.<sup>1</sup> These beautiful disks are for the most part obtainable from guano, and from soundings in tropical and antarctic seas.—From these we pass on to the genus *Actinoptychus* (Fig. 180), of which also the frustules are discoidal in form,

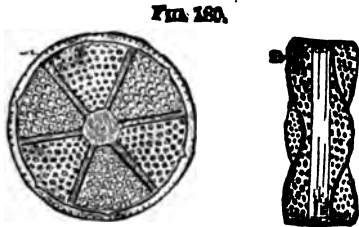

*Actinoptychus undulatus*.—A, side view;  
B, front view.

but of which each valve, instead of being flat, has an undulating surface, as is seen in front view (B); giving to the side view (A) the appearance of being marked by radiating bands. Owing to this peculiarity of shape, the whole surface cannot be brought into focus at once except with a low power; and the difference of aspect which the different radial divisions present in Fig. 180, is simply due to the fact that one set is out of focus whilst the other is in it, since the appearances are reversed by

merely altering the focal adjustment. The number of radial divisions has been considered a character of sufficient importance to serve for the distinction of species; but this is probably subject to variation; since we not unfrequently meet with disks, of which one has (say) 8 and another 10 such divisions, but which are precisely alike in every other particular. The valves of this genus also are very abundant in the Infusorial earth of Richmond, Bermuda, and Oran (Fig. 191, *b, b, b*); and many of the same species have been found recently in guano, and in the seas of various parts of the world. The frustules in their living state appear to be generally attached to Seaweeds or Zoophytes.

291. The Bermuda earth also contains the very beautiful form (Plate I., fig. 3), which, though scarcely separable from *Actinoptychus* except by its marginal spines, has received from Prof. Ehrenberg the distinctive appellation of *Heliopelta* (sun-shield). The object is represented as seen on its *internal* aspect by the Parabolic Illuminator (§ 105), which brings into view certain features that can scarcely be seen by ordinary transmitted light. Five of the radial divisions are seen to be marked out into circular areolæ; but in the five which alternate with them, a minute beaded structure is observable. This may be shown by careful adjustment of the focus to exist over the whole interior of the valve, even on the divisions in which the circular areolation is here displayed; and it hence appears that this marking belongs to the *internal* layer<sup>2</sup> (§ 289), and that the circular areolation exists in the *outer* layer of the silicified lorica. In the alternating divisions whose surface is here displayed, the areolation of the outer layer, when brought into view by focussing down to it, is seen to be formed by equilateral triangles; it is not, however, nearly so well marked as the circular areolation of the first-mentioned divisions. The dark spots seen at the ends of the rays, like the dark centre, appear to be solid tubercles of siliceous matter not traversed by markings,

<sup>1</sup> See Greville in "Quart. Journ. of Microsc. Science," Vol. vii (1859), p. 158, and in "Transact. of Microsc. Soc.," Vol. viii., N.S. (1860), p. 102, and Vol. x. (1862), p. 41; also Wallich in the same Transactions, Vol. viii. (1860), p. 44.

<sup>2</sup> It is stated by Mr. Stodder ("Quart. Journ. of Microsc. Science," Vol. iii., N.S., 1863, p. 215), that not only has he seen, in broken specimens, the inner granulated plate projecting beyond the outer, but that he has found the inner plate altogether separated from the outer. The Author is indebted to this gentleman for pointing out that his Figure represents the *inner* surface of the valve.



as in many other Diatoms; most assuredly they are *not* orifices, as supposed by Prof. Ehrenberg. Of this type, again, specimens are found presenting 6, 8, 10, or 12 radial divisions, but in other respects exactly similar; on the other hand, two specimens agreeing in their number of divisions may exhibit minute differences of other kinds; in fact, it is rare to find two that are *precisely* alike. It seems probable, then, that we must allow a considerable latitude of variation in these forms, before attempting to separate any of them as distinct species.—Another very beautiful discoidal Diatom, which occurs in Guano, and is also found attached to Sea-weeds from different parts of the world (especially to a species employed by the Japanese in making soup), is the *Arachnoidiscus* (Plate XI.), so named from the resemblance which the beautiful markings on its disk cause it to bear to a Spider's web. According to Mr. Shadbolt,<sup>1</sup> who first carefully examined its structure, each valve consists of two layers; the outer one, a thin flexible horny membrane, indestructible by boiling in nitric acid; the inner one, siliceous. It is the former which has upon it the peculiar spider's web-like markings: whilst it is the latter that forms the supporting frame-work, which bears a very strong resemblance to that of a circular Gothic window. The two can occasionally be separated entire, by first boiling the disks for a considerable time in nitric acid, and then carefully washing them in distilled water. Even without such separation, however, the distinctness of the two layers can be made out by focussing for each separately under a 1-4th or 1-5th inch Objective; or by looking at a valve as an opaque object (either by the Parabolic Illuminator, or by the Lieberkühn, or by a side light) with a 4-10ths inch Objective, first from one side, and then from the other.<sup>2</sup>—This family is connected with the succeeding by the small group of *Eupodisceæ*, the members of which agree with the *Coscinodisceæ* in the general character of their discoid frustules, and with the *Biddulphiæ* in having tubercular processes on their lateral surfaces. In the beautiful *Aulacodiscus* (Plate I., Fig. 5) these tubercles are situated near the margin, and are connected with bands radiating from the centre; the surface also is frequently inflated in a manner that reminds us of *Actinoptychus*. These forms are for the most part obtained from Guano.

292. The members of the next Family *Biddulphiæ* differ greatly in their general form from the preceding; being remarkable for the great development of the lateral valves, which, instead of being nearly flat or discoidal, so as only to present a thin edge in front view, are so convex or inflated as always to enter largely into the front view, causing the central zone to appear like a band between them. This band is very narrow when the new frustules are first produced by self-division (§ 278); but it increases gradually in breadth, until the new frustule is fully formed and is itself undergoing the same duplicative change. In *Biddulphia* (Fig. 167) the frustules have a quadrilateral form, and remain coherent by their alternate angles (which are elongated into toothlike projections), so as to form a zigzag chain. They are marked externally by ribbings which seem to be indicative of internal *costæ* partially subdividing the cavity. Nearly allied to this is the beautiful genus *Isthmia* (Fig. 181), in which the frustules have a trapezoidal form owing to the oblique pro-

<sup>1</sup> "Transact. of Microsc. Society," First Series, Vol. iii, p. 49.

<sup>2</sup> These valves afford admirable objects for showing the 'conversion of relief' in Nachet's Stereo-Pseudoscopic Microscope (§ 38).

PLATE XL

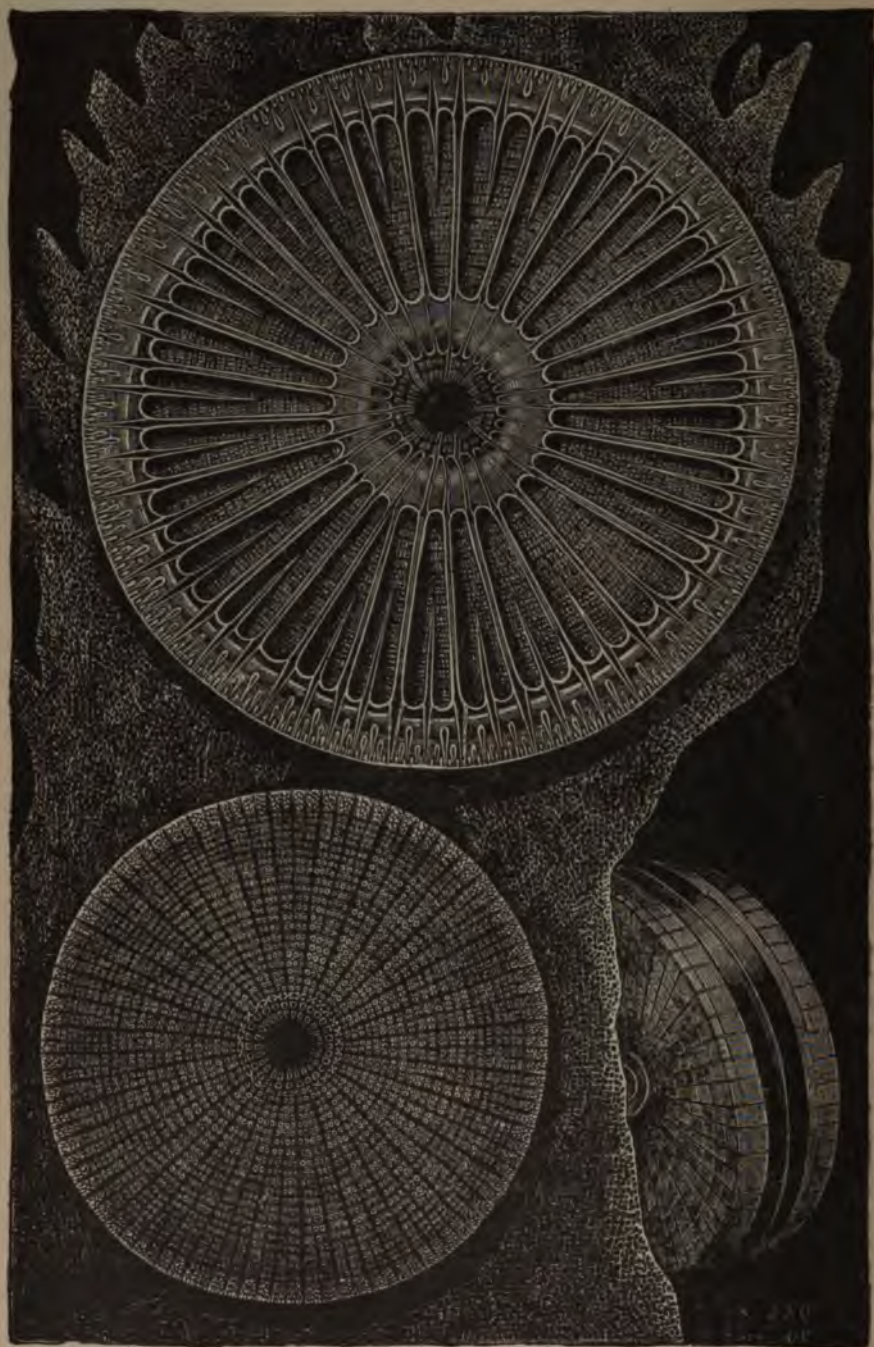

ARACHNOIDISCUS JAPONICUS (after R. Beck).

The specimens attached to the surface of a Sea-weed, are represented as seen under a 1-4th Objective, with Lieberkühn illumination:—a, internal surface; b, external surface; c, front view showing incipient subdivision.



longation of the valves; the lower angle of each frustule is coherent to the middle of the next one beneath, and from the basal frustule proceeds a stipes by which the filament is attached. Like the preceding, this genus is marine, and is found attached to the *Algæ* of our own shores. The areolated structure of its surface (Fig. 163) is very conspicuous both in the valves and in the connecting 'hoop;' and this hoop, being silicified, not only connects the two new frustules (as at *b*, Fig. 181), until they have separated from each other, but, after such separation, remains for a time round one of the frustules, so as to give it a truncated appearance (*a*, *c*).

293. The Family *Anguliferae*, distinguished by the angular form of its valves in their lateral aspect, is in many respects closely allied to the preceding; but in the comparative flattening of their valves, its members more resemble the *Coscinodisceæ* and *Eupodisceæ*. Of this family we have a characteristic example in the genus *Triceratium*; of which striking form a considerable number of species are met with in the Bermuda and other Infusorial earths, while others are inhabitants of the existing ocean and of tidal rivers. The *T. favus* (Fig. 164), which is one of the largest and most regularly-marked on any of these, occurs in the mud of the Thames and in various other estuaries on our own coast; it has been found, also, on the surface of large sea-shells from various parts of the world, such as those of *Hippopus* and *Haliotis*, before they have been cleaned; and it presents itself likewise in the Infusorial earth of Petersburg (U. S.). The projections at the angles which are shown in that species, are prolonged in some other species into 'horns,' whilst in others, again, they are mere tubercular elevations. Although the triangular form of the frustule, when looked at sideways, is that which is characteristic of the genus, yet in some of the species there seems a tendency to produce *quadrangular* and even *pentagonal* forms; these being marked as *varieties* by their exact correspondence in sculpture, color, etc., with the normal triangular forms.<sup>1</sup> This departure is extremely remarkable, since it breaks down what seems at first to be the most distinctive character of the genus; and its occurrence is an indication of the degree of latitude which we ought to allow in other cases. It is difficult, in fact, to distinguish the square forms of *Triceratium* from those included in the genus *Amphitetras*, which is chiefly characterized by the cubiform shape of its frustules. In the latter, the frustules cohere at their angles so as to form zigzag filaments, whilst in the former the frustules are usually free, though they have occasionally been found catenated.—Another group that seems allied to the *Biddulphiae* is the curious assemblage of forms brought together in the Family *Chatocerae*, some of the filamentous types of which seem also allied to the *Melosireæ*. The peculiar dis-

FIG. 181.

*Isthmia nervosa.*

<sup>1</sup> See Mr. Brightwell's excellent Memoirs 'On the genus *Triceratium*,' in "Quart. Journ. of Microsc. Science," Vol. i. (1853), p. 245, Vol. iv. (1856), p. 272, Vol. vi. (1858), p. 153; also Wallich in the same Journal, Vol. iv. (1858), p. 242; and Greville in "Transact. of Microsc. Soc.," N. S., Vol. ix. (1861), pp. 43, 69.



tion of this group consists in the presence of tubular 'awns,' frequently proceeding from the connecting hoop, sometimes spinous and serrated, and often of great length (Fig. 182); by the interlacing of which the frustules are united into filaments, whose continuity, however, is easily broken. In the genus *Bacteriastrum* (Fig. 183) there are sometimes as many as twelve of these awns, radiating from each frustule like the spokes of a wheel, and in some instances regularly bifurcating. With this group is associated the genus *Rhizosolenia*, of which several species are distinguished by the extraordinary length of the frustule (which may be from 6 to 20 times its breadth), giving it the aspect of a filament (Fig. 184), by a transverse annulation that imparts to this filament a jointed appearance, and by the termination of the frustule at each end in a cone, from the apex of which a straight awn proceeds. It is not a little remarkable that the greater number of the examples of this curious family are obtained from the stomachs of Ascidians, Salpæ, Holothuræ, and other Marine animals.<sup>1</sup>

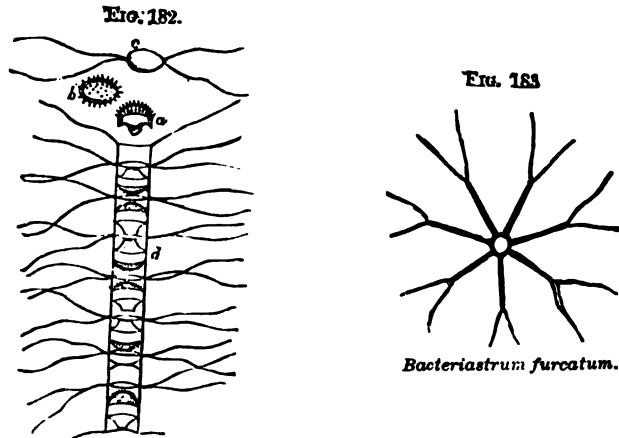

*Chatoceros Wighamii*:—a, front view, and b, side view of frustule; c, side view of connecting hoop and awns; d, entire filament.

294. The second principal division (B) of the Diatomaceæ consists, it will be remembered, of those in which the frustules have a median longitudinal line and a central nodule. In the first of the Families which it includes, that of *Cocconeideæ*, the central nodule is obscure or altogether wanting on one of the valves, which is distinguished as the inferior. This family consists of but a single genus *Cocconeis*, which includes, however, a great number of species, some or other of them occurring in every part of the globe. Their form is usually that of ellipsoidal disks, with surfaces more or less exactly parallel, plane, or slightly curved; and they are very commonly found adherent to each other. The frustules in this genus are frequently invested by a membranous envelope which forms a border to them; but this seems to belong to the immature state, subsequently disappearing more or less completely.—Another Family in which there is a dissimilarity in the two lateral surfaces, is that of *Achnantheæ*; the frustules of which are remarkable for the bend they show in the direc-

<sup>1</sup> See Brightwell in "Quart. Journ. of Microsc. Science," Vol. iv. (1856), p. 106; Vol. vi. (1858), p. 93; Wallich in "Trans. of Microsc. Soc.," N.S., Vol. viii. (1860), p. 48; and West in the same, p. 151.

tion of their length, often more conspicuously than in the example here represented. This family contains free, adherent, and stipitate forms; one of the most common of the latter being the *Achnanthes longipes* (Fig. 185), which is often found growing on Marine Algæ. The difference between the markings of the upper and lower valves is here distinctly seen; for while both are traversed by striæ, which are resolvable under a sufficient power into rows of dots, as well as by a longitudinal line which sometimes has a nodule at each end (as in *Navicula*), the lower valve (*a*) has also a transverse line, forming a *sturos* or cross, which is wanting in

FIG. 184.

FIG. 185.

FIG. 186.

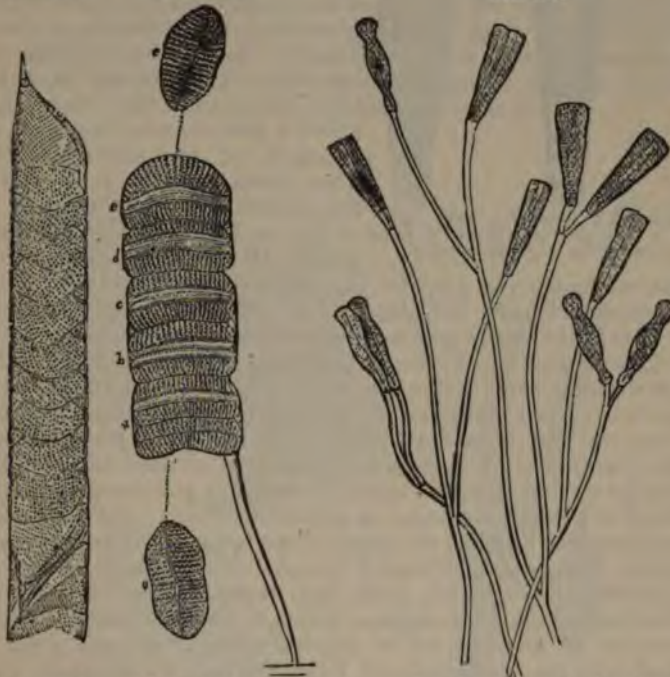

*Rhizosolenia imbricata.*

*Achnanthes longipes*:—*a*, *b*, *c*, *d*, *e* successive frustules in different stages of self-division.

*Gomphonema geminatum*: its frustules connected by a dichotomous stipes.

the upper valve (*e*). A persistence of the connecting membrane, so as to form an additional connection between the cells, may sometimes be observed in this genus; thus in Fig. 185, it not only holds together the two new frustules resulting from the subdivision of the lowest cell, *a*, which are not yet completely separated the one from the other, but it may be observed to invest the two frustules, *b* and *c*, which have not merely separated, but are themselves beginning to undergo binary subdivision; and it may also be perceived to invest the frustule *d*, from which the frustule *e*, being the terminal one, has more completely freed itself.—In the Family *Cymbellæ*, on the other hand, both valves possess the longitudinal line with a nodule in the middle of its length; but the valves have the general form of those of the *Eunotia*, and the line is so much nearer one margin than the other, that the nodule is sometimes rather

marginal than central, as we see in *Cocconema* (Fig. 192).—The *Gomphonemææ*, like the *Meridiææ* and *Licmophoreææ*, have frustules which are cuneate or wedge-shaped in their front view (Figs. 186, 187), but are distinguished from those forms by the presence of the longitudinal line and central nodule. Although there are some free forms in this family, the greater part of them, included in the genus *Gomphonema*, have their

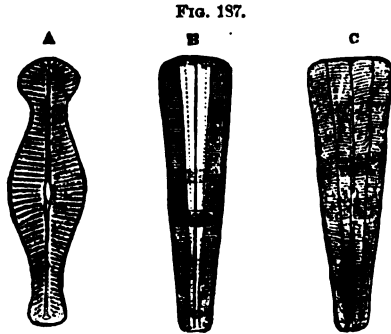

FIG. 187.  
*Gomphonema geminatum*, more highly magnified: a, side view of frustule; b, front view; c, frustule in the act of self-division.

frustules either affixed at their bases or attached to a stipes. This stipes seems to be formed by an exudation from the frustule, which is secreted only during the process of self-division: hence when this process has been completed, the extension of the single filament below the frustule ceases; but when it recommences, a sort of joint or articulation is formed, from which a new filament begins to sprout for each of the half-frustules; and when these separate, they carry apart the peduncles which support them, as far as their divergence can take place. It is in this manner that the dichotomous character is given to the entire stipes (Fig. 186). The species of *Gomphonema* are, with scarcely an exception, inhabitants of fresh water, and are among the commonest forms of Diatomaceæ.

295. Lastly, we come to the large Family *Naviculeææ*, the members of which are distinguished by the symmetry of their frustules as well in the lateral as in the front view, and by the presence of a median longitudinal line and central nodule in both valves. In the genus *Navicula* and its allies, the frustules are free or simply adherent to each other; whilst in another large section they are included within a gelatinous envelope, or are inclosed in a definite tubular or gelatinous frond. Of the genus *Navicula* an immense number of species have been described, the grounds of separation being often extremely trivial. Those which have a lateral sigmoid curvature (Fig. 165) have been separated by Prof. W. Smith under the designation *Pleurosigma*, which is now generally adopted; but his separation of another set of species under the name *Pinnularia* (which had been previously applied by Ehrenberg to designate the striated species), on the ground that its striæ (costæ) are not resolvable into dots, was not considered valid by Mr. Ralfs, on the ground that in many of the more minute species it is impossible to distinguish with certainty between striæ and costæ. Mr. Slack has since given an account of the resolution of the so-called costæ of twelve species of *Pinnularia* into beaded structures.<sup>1</sup> The beautiful genus *Stauroneis*, which belongs to the same group, differs from all the preceding forms in having the central nodule of each valve dilated laterally into a band free from striæ, which forms a cross with the longitudinal band.

296. The multitudinous species of the genus *Navicula* are for the most part inhabitants of fresh water; and they constitute a large part of most of the so-called 'infusorial earths' which were deposited at the bottoms of lakes. Among the most remarkable of such deposits are the substances

<sup>1</sup> "Monthly Microscopical Journal," Vol. vi. (1871), p. 71.



largely used in the arts for the polishing of metals, under the names of Tripoli and rotten-stone; these consist in great part of the frustules of *Naviculæ* and *Pinnulariæ*. The Polierschiefer or 'polishing slate' of Bilin in Bohemia, the powder of which is largely used in Germany for the same purpose, and which also furnishes the fine sand used for the most delicate castings in iron, occurs in a series of beds averaging fourteen feet in thickness; and these present appearances which indicate that they have been at some time exposed to a high temperature. The well-known 'Turkey stone,' so generally employed for the sharpening of edge-tools, seems to be essentially composed of a similar aggregation of frustules of *Naviculæ*, etc., which has been consolidated by heat.—The species of *Pleurosigma*, on the other hand, are for the most part either marine or are inhabitants of brackish water; and they comparatively seldom present themselves in a fossilized state. Of *Stauroneis*, some species inhabit fresh water, while others are marine; and the former present themselves frequently in certain 'infusorial earths.'

FIG. 188.



*Schizonema Grevillii*.—A, natural size; B, portion magnified five diameters; C, filament magnified 100 diameters; D, single frustule.

297. Of the members of the Suo-family *Schizonemææ*, consisting of those *Naviculææ* in which the frustules are united by a gelatinous envelope, some are remarkable for the great external resemblance they bear to acknowledged Algæ. This is especially the case with the genus *Schizonema*; in which the gelatinous envelope forms a regular tubular frond, more or less branched, and of nearly equal diameter throughout, within which the frustules lie either in single file or without any definite arrangement (Fig. 188); all these frustules having arisen from the self-division of one individual. In the genus *Mastogloia*, which is specially distinguished by having the annulus furnished with internal costæ projecting into the cavity of the frustule, each frustule is separately sup-

ported on a gelatinous cushion (Fig. 189, B), which may itself be either borne on a branching stipes (A), or may be aggregated with others into an indefinite mass (Fig. 190).—The careful study of these composite forms is a matter of great importance; since it enables us to bring into comparison with each other great numbers of frustules which have unquestionably a common descent, and which must therefore be accounted as of the same species; and thus to obtain an idea of the *range of variation* prevailing in this group, without a knowledge of which specific definition is altogether unsafe. Of the very strongly marked varieties which may occur within the limits of a single species, we have an example in the valves C, D, E, F (Fig. 169), which would scarcely have been supposed to belong to the same specific type, did they not occur upon the same stipes. The careful study of these varieties in every instance in which any disposition to variation shows itself, so as to

FIG. 189.



FIG. 190.

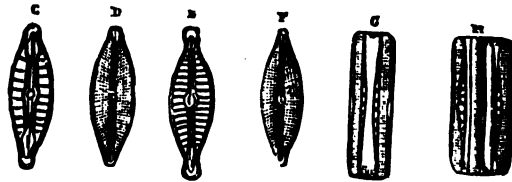

Fig. 189. *Mastogloia Smithii*.—A, entire stipes; B, frustule in the gelatinous envelope; C—F, different forms of frustule as seen in side view; G, front view; H, frustule undergoing subdivision.  
Fig. 190. *Mastogloia lanceolata*.

*reduce* the enormous number of species with which our systematic treatises are loaded, is a pursuit of far greater real value than the *multiplication* of species by the detection of such minute differences as may be presented by forms discovered in newly explored localities; such differences, as already pointed out, being, probably, in a large proportion of cases, the result of the multiplication of some one form, which, under modifying influences that we do not yet understand, has departed from the ordinary type. The more faithfully and comprehensively this study is carried out in *any* department of Natural History, the more does it prove that the range of variation is far more extensive than had been previously imagined; and this is especially likely to be the case with such humble organisms as those we have been considering, since they are

obviously more influenced than those of higher types by the conditions under which they are developed, whilst, from the very wide Geographical range through which the same forms are diffused, they are subject to very great diversities of such conditions.

298. The general habits of this most interesting group cannot be better stated than in the words of Prof. W. Smith. "The Diatomaceæ inhabit the sea or fresh water; but the species peculiar to the one are never found in a living state in any other locality; though there are some which prefer a medium of a mixed nature, and are only to be met with in water more or less brackish. The latter are often found in great abundance and variety in districts occasionally subject to marine influences, such as marshes, in the neighborhood of the sea, or the deltas of rivers, where, on the occurrence of high tides, the freshness of the water is affected by percolation from the adjoining stream, or more directly by the occasional overflow of its banks. Other favorite habitats of the Diatomaceæ are stones of mountain streams or waterfalls, and the shallow pools left by the retiring tide at the mouths of our larger rivers. They are not, however, confined to the localities I have mentioned—they are, in fact, most ubiquitous, and there is hardly a roadside ditch, water trough, or cistern, which will not reward a search, and furnish specimens of the tribe." Such is their abundance in some rivers and estuaries, that their multiplication is affirmed by Prof. Ehrenberg to have exercised an important influence in blocking up harbors and diminishing the depth of channels! Of their extraordinary abundance in certain parts of the Ocean, the best evidence is afforded by the observations of Sir J. D. Hooker upon the Diatomaceæ of the southern seas; for within the Antarctic Circle they are rendered peculiarly conspicuous by becoming inclosed in the newly formed ice, and by being washed up in myriads by the sea on to the 'pack' and 'bergs,' everywhere staining the white ice and snow of a pale ochreous brown. A deposit of mud, chiefly consisting of the siliceous loriceæ of Diatomaceæ, not less than 400 miles long and 120 miles broad, was found at a depth of between 200 and 400 feet, on the flanks of Victoria Land in 70° South latitude. Of the thickness of this deposit no conjecture could be formed; but that it must be continually increasing is evident, the silex of which it is in a great measure composed being indestructible. A fact of peculiar interest in connection with this deposit, is its extension over the submarine flanks of Mount Erebus, an active Volcano of 12,400 feet elevation; since a communication between the ocean waters and the bowels of a volcano, such as there are other reasons for believing to be occasionally formed, would account for the presence of Diatomaceæ in volcanic ashes and pumice, which was discovered by Prof. Ehrenberg. It is remarked by Sir J. D. Hooker, that the universal presence of this invisible vegetation throughout the South Polar Ocean is a most important feature, since there is a marked deficiency in this region of higher forms of vegetation; and were it not for them, there would neither be food for aquatic Animals, nor (if it were possible for these to maintain themselves by preying on one another) could the Ocean waters be purified of the carbonic acid which animal respiration and decomposition would be continually imparting to them. It is interesting to observe that some species of marine Diatoms are found through every degree of latitude between Spitzbergen and Victoria Land, whilst others seem limited to particular regions. One of the most singular instances of the preservation of Diatomaceous forms, is their existence in Guano; into which they must have passed from the



intestinal canals of the Birds of whose accumulated excrement that substance is composed; those birds having received them, it is probable, from Shell-fish, to which these minute organisms serve as ordinary food (§ 300).

299. The indestructible nature of the silicified casings of *Diatomaceæ* has also served to perpetuate their presence in numerous localities from which their living forms have long since disappeared; for the accumulation of sediment formed by their successive production and death, even on the bed of the Ocean, or on the bottoms of fresh-water Lakes, gives rise to deposits which may attain considerable thickness, and which, by subsequent changes of level, may come to form part of the dry land. Thus very extensive Siliceous strata, consisting almost entirely of marine *Diatomaceæ*, are found to alternate, in the neighborhood of the Mediterranean, with Calcareous strata chiefly formed of *Foraminifera* (Chap. XII.); the whole series being the representative of the Chalk formation of Northern Europe, in which the silex that was probably deposited at first in this form has undergone conversion into *flint*, by agencies hereafter to be considered (Chaps. XII., XXI.). Of the Diatomaceous composition of these strata we have a characteristic example in Fig. 191, which represents the Fossil *Diatomaceæ* of Oran in Algeria. The so-called 'infusorial earth' of Richmond in Virginia, and that of Bermuda, also Marine deposits, are very celebrated among Microscopists for the number and beauty of the forms they have yielded; the former constitutes a stratum of 18 feet in thickness, underlying the whole city, and extending over an area whose limits are not known. Several deposits of more limited extent, and apparently of fresh-water origin, have been found in our own islands; as for instance at Dolgelly in North Wales, at South Mourne in Ireland (Fig. 192), and in the island of Mull in Scotland. Similar deposits in Sweden and Norway are known under the name of *berg-mehl* or mountain-flour; and in times of scarcity the inhabitants of those countries are accustomed to mix these substances with their dough in making bread. This has been supposed merely to have the effect of giving increased bulk to their loaves, so as to render the really nutritive portion more satisfying; but as the *berg-mehl* has been found to lose from a quarter to a third of its weight by exposure to a red-heat, there seems a strong probability that it contains Organic matter enough to render it nutritious in itself. When thus occurring in strata of a fossil or sub-fossil character, the Diatomaceous deposits are generally distinguishable as white or cream-colored powders of extreme fineness.

300. For collecting fresh *Diatomaceæ*, those general methods are to be had recourse to which have been already described (§ 269). "Their living masses," says Prof. W. Smith, "present themselves as colored fringes attached to larger plants, or forming a covering to stones or rocks in cushion-like tufts—or spread over their surface as delicate velvet—or depositing themselves as a filmy stratum on the mud, or intermixed with the scum of living or decayed vegetation floating on the surface of the water. Their color is usually a yellowish-brown of a greater or less intensity, varying from a light chestnut, in individual specimens, to a shade almost approaching black in the aggregated masses. Their presence may often be detected without the aid of a microscope, by the absence, in many species, of the fibrous tenacity which distinguishes other plants: when removed from their natural position they become distributed through the water, and are held in suspension by it, only subsiding after some little time has elapsed." Notwithstanding every care, the collected specimens

are liable to be mixed with much foreign matter: this may be partly got rid of by repeated washings in pure water, and by taking advantage, at the same time, of the different specific gravities of the Diatoms and of the intermixed substances, to secure their separation. Sand, being the heaviest, will subside first; fine particles of mud on the other hand, will float after the Diatoms have subsided. The tendency of living Diatoms to make their way towards the light, will afford much assistance in procuring the free forms in a tolerably clean state; for if the gathering which contains them be left undisturbed for a sufficient length of time in a shallow vessel exposed to the sunlight, they may be skimmed from the surface. Marine forms must be looked-for upon Sea-weeds, and in the fine mud or sand of soundings or dredgings; they are frequently found also, in considerable numbers, in the stomachs of Holothuriæ, Ascidians,

FIG. 191.



*Fossil Diatomaceæ, etc., from Oran:—a, a, a, Coseinodiscus; b, b, b, Actinocyclus; c, Dictyochoya fibula; d, Lithasteriscus radiatus; e, Spongolithis acicularis; f, f, Grammatophora parallela (side view); g, g, Grammatophora angulosa (front view).*

and Salpæ, in those of the oyster, scallop, whelk, and other testaceous Mollusks, in those of the crab and lobster, and other Crustacea, and even in those of the sole, turbot, and other Flat-fish. In fact the Diatom-collector will do well to examine the digestive cavity of *any* small aquatic animals that may fall in his way; rare and beautiful forms having been obtained from the interior of *Noctiluca* (Fig. 297). The separation of the Diatoms from the other contents of these stomachs must be accomplished by the same process as that by which they are obtained from Guano or the calcareous 'infusorial earths'; of this, the following are the most essential particulars:—The guano or earth is first to be washed several times in pure water, which should be well stirred, and the sediment then allowed to subside for some hours before the water is poured off, since, if it be decanted too soon, it may carry the lighter forms away with it. Some kinds of earth have so little impurity that one washing suffices; but in any case it is to be continued so long as the water remains

colored. The deposit is then to be treated, in a flask or test-tube, with Hydrochloric (muriatic) acid; and after the first effervescence is over, a gentle heat may be applied. As soon as the action has ceased, and time has been given for the sediment to subside, the acid should be poured off, and another portion added; and this should be repeated as often as any effect is produced. When hydrochloric acid ceases to act, strong Nitric acid should be substituted; and after the first effervescence is over, a continued heat of about 200° should be applied for some hours. When sufficient time has been given for subsidence, the acid may be poured off and the sediment treated with another portion; and this is to be repeated until no further action takes place. The sediment is then to be washed until all trace of the acid is removed: and, if there have been no admixture of siliceous sand in the earth or guano, this sediment will consist almost entirely of *Diatomacea*, with the addition, perhaps, of Spongespicules. The separation of siliceous sand, and the subdivision of the

FIG. 132



*Fossil Diatomacea*, etc., from Mourne Mountain, Ireland:—*a, a, a*, *Gallionella* (*Melosira*) *procera*, and *G. granulata*; *d, d, d*, *G. biseriata* (side view); *b, b*, *Surirella plicata*; *c*, *S. craticula*; *k*, *S. caledonica*; *e*, *Gomphonema gracile*; *f*, *Cocconeia fusidium*; *g*, *Tabellaria vulgaris*; *h*, *Pinnularia dactylus*; *i*, *P. nobilis*; *l*, *Synedra ulna*.

entire aggregate of Diatoms into the larger and the finer kinds, may be accomplished by stirring the sediment in a tall jar of water, and then, while it is still in motion, pouring off the supernatant fluid as soon as the coarser particles have subsided; this fluid should be set aside, and, as soon as a finer sediment has subsided, it should again be poured off; and this process may be repeated three or four times at increasing intervals, until no further sediment subsides after the lapse of half an hour. The first sediment will probably contain all the sandy particles, with, perhaps, some of the largest Diatoms, which may be picked out from among them; and the subsequent sediments will consist almost exclusively of Diatoms, the sizes of which will be so graduated, that the earliest sediments may be examined with the lower powers, the next with medium powers, while



the latest will require the higher powers—a separation which is attended with great convenience.<sup>1</sup> It sometimes happens that fossilized Diatoms are so strongly united to each other by Siliceous cement, as not to be separable by ordinary methods; in this case, small lumps of the deposit should be boiled for a short time in a weak Alkaline solution, which will act upon this cement more readily than on the siliceous frustules; and as soon as they are softened so as to crumble to mud, this must be immediately washed in a large quantity of water, and then treated in the usual way. If a very weak alkaline solution does not answer the purpose, a stronger one may then be tried. This method, devised by Prof. Bailey, has been practised by him with much success in various cases.<sup>2</sup>

301. The mode of mounting specimens of *Diatomaceæ* will depend upon the purpose which they are intended to serve. If they can be obtained quite fresh, and if it be desired that they should exhibit, as closely as possible the appearance presented by the living plants, they should be put-up in aqueous media (§ 206) within Cement-cells (§ 211); but if they are not thus mounted within a short time after they have been gathered, about a tenth-part of alcohol should be added to the water. If it be desired to exhibit the stipitate forms in their natural parasitism upon other aquatic plants, the entire mass may be mounted in Deane's Medium or in Glycerine jelly (§ 206 *h*), in a deeper cell; and such a preparation is a very beautiful object for the back-ground illumination. If, on the other hand, the minute structure of the siliceous envelope is the feature to be brought into view, the fresh Diatoms must be boiled in nitric or hydrochloric acid, which must then be poured off (sufficient time being allowed for the deposit of the residue); and the sediment, after being washed, should be boiled in water with a small piece of soap, whereby the Diatoms will be cleansed from the flocculent matter which they often obstinately retain.<sup>3</sup> After a further washing in pure water, they are to be either mounted in Balsam in the ordinary manner (§ 210), or to be set-up 'dry' on a very thin slide (§§ 165, 169). In order to obtain a satisfactory view of their markings, Objectives of very wide angular aperture are required, and all the refinements which have recently been introduced into the methods of Illumination need to be put in practice. (Chaps. III., IV.)—It will often be convenient to mount certain particular forms of *Diatomaceæ* separately from the general aggregate; but on account of their minuteness, they cannot be selected and removed by the usual means. The larger forms, which may be readily distinguished under a Simple Microscope, may be taken-up by a camel-hair pencil which has been so trimmed as to leave two or three hairs projecting beyond the rest. But the smaller can only be dealt with by a single fine bristle

<sup>1</sup> A somewhat more complicated method of applying the same principle is described by Mr. Okeden, in the "Quart. Journ. of Microsc. Science," Vol. iii. (1855), p. 158. The Author believes, however, that the method above described will answer every purpose.

<sup>2</sup> For other methods of cleaning and preparing Diatoms, see "Quart. Journ. of Microsc. Science," Vol. vii. (1859), p. 167, and Vol. i., N.S. (1861), p. 143; and "Trans. of Microsc. Soc.," Vol. xi., N.S. (1863), p. 4.—A little book entitled "Practical Directions for collecting, preserving, transporting, preparing, and mounting Diatoms" (New York, 1877), containing Papers by Professors A. Mead Edwards, Christopher Johnson, and Hamilton L. Smith, will be found to contain much useful information.

<sup>3</sup> See Prof. H. L. Smith in "Amer. Journ. of Microscopy," Vol. v. (1880), p. 257.—It is important that the soap should be free from kaolin, silica, or any other insoluble matter.

or stout sable-hair, which may be inserted into the cleft-end of a slender wooden-handle; and if the bristle or hair should be split at its extremity in a brush-like manner, it will be particularly useful. (Such split-hairs may always be found in a Shaving-brush which has been for some time in use; those should be selected which have their split-portions so closely in contact, that they appear single until touched at their ends.) When the split extremity of such a hair touches the glass-slide, its parts separate from each other to an amount proportionate to the pressure; and, on being brought up to the object, first pushed to the edge of the fluid on the slide, may generally be made to seize it. A very experienced American Diatomist, Prof. Hamilton Smith, strongly recommends a thread of glass drawn-out to capillary fineness and flexibility, by which (he says) the most delicate Diatom may be safely taken up, and deposited upon a slide damped by the breadth.—For the selection and transference of Diatoms under the Compound Microscope, recourse may be had to some of the forms of ‘mechanical finger’ which have been recently devised by American Diatomists.<sup>1</sup>

---

<sup>1</sup> For a description of those of Prof. Hamilton Smith and Dr. Reznor, see “*Journ. of Roy. Microsc. Soc.*,” Vol. ii. (1879), p. 951; and that of Mr. Veeder, Vol. iii. (1880), p. 700, of the same Journal.

## CHAPTER VII.

## PROTOPHYTIC AND OTHER FUNGI.—LICHENS.

302. IN the lowest forms of the group of Fungi, we return to the simplest type of Vegetation—the single cell; and such forms, equally with the lowest *Algæ*, rank as *Protophytes*. Their essential difference from the Protophytic *Algæ* seems to lie in their incapacity for the formation of Chlorophyll and of carbon-compounds, under the influence of Light, out of the simple binary compounds—Water, Carbonic Acid, and Ammonia—supplied by the Inorganic world; and in their dependence (like Animals, § 220) upon those more complex combinations which the Organic world alone supplies. There seems, however, to be this general difference between the nutrition of Fungi and that of ordinary Animals: that the former not only live, but thrive best, in the midst of *decomposing* or *decomposable* Organic matter, apparently utilizing the products of such decomposition; whilst the latter directly convert into their own substance the nitrogenous compounds prepared for them by Plants. There are, however, cases in which this distinction, also, seems to fail; and in which it is impossible, in the present state of our knowledge, to draw a definite line of division between *Fungi* and *Protozoa* (§ 322).

303. Among the Protophytic *Fungi*, there are none of which the study is more practically important, than the group of *Schizomycetes*; consisting of a series of very minute organisms, known as *Bacteria*, *Vibriones*, etc., which were formerly ranked by Ehrenberg and Dujardin among Animalcules. They are all aquatic in their habit, and are in that respect allied to *Algæ*; but they cannot live in pure water, thriving best in liquids that contain decomposing or decomposable organic matter; whilst many of them also grow and reproduce themselves in solutions in which ammonia-salts of the vegetable acids (acetates, tartrates, or citrates) are combined with purely inorganic ash-salts, so that they may be 'cultivated' in such liquids for the purposes of study.<sup>1</sup> Thus the *Schizomycetes* resemble ordinary Plants in forming Nitrogenized compounds out of ammonia, which Animals cannot do; while they differ from green Plants in their inability to form Carbon-compounds by the decomposition of carbonic acid, requiring for their support the carbo-hydrates or their derivatives.—They all consist of minute cells, which multiply rapidly by subdivision; and most of them, at some stage of their existence, have the power of moving more or less quickly through the liquid they inhabit, by the action of *flagella*. Although usually colorless, or nearly so, they sometimes form reddish, bluish, or brownish coloring matters;

<sup>1</sup> Cohn's solution is composed of 1 part of Potassium Phosphate, 1 part of Magnesium Sulphate, 2 parts of Ammonium Tartrate, and 0.1 part of Calcium Chloride, dissolved in 200 parts of distilled water.—See also p. 128 *note*.



and thus, when they multiply to a sufficient extent, make their presence apparent to the unaided eye, either as colored films on the sides of the glass jars holding the solutions, or as (in the cases of blood-colored milk and blue-green pus) imparting their color to the whole liquid. Liquids in which any of these *Schizomycetes* are actively developing themselves, usually bear on their surface a gelatinous scum, which is termed by Prof. Cohn (who first drew attention to it) the *Zooglæa*. This scum, when examined microscopically, is found to contain *Schizomycetes*, sometimes of several different kinds, and in different stages of development, often mingled with true *Infusoria*, matted together into a mass; at the edges of which they present themselves in a more separated condition, and seem escaping to disperse themselves freely through the liquid beneath. By Prof. Cohn,<sup>1</sup> who has made a special study of this group, it is considered to include a large number of generic and specific types, whose distinctness is always preserved; but other observers, who have devoted themselves to the more prolonged and complete study (by 'cultivation') of a small number of forms, seem to have made it clear that there is—at least in certain types—a wide range of variation; so that when the entire life-history of any one type shall be completely known, a number of supposed species will be merged in it, either as *transitory phases* of its existence, or as *varieties* resulting from differences in the media in which they develop themselves.<sup>2</sup> There are, however, five well-marked types, of each of which it will be desirable to give a separate account; namely—1. *Micrococcus*; 2. *Bacterium*; 3. *Bacillus*; 4. *Vibrio*; and 5. *Spirillum*.

304. The *Micrococci* are darkish or colored granules, so minute as not to be measurable with certainty, and destitute of any power of movement; which may occur either solitarily, or forming small groups or beaded chains, such as would be produced by cell-division; but which may also accumulate in irregular aggregations. The *Monas prodigiosa* of Ehrenberg, which is sometimes found imparting to the surface of mouldy bread a blood-red tinge (attributed by the superstitious to a miraculous exudation of blood), is regarded by Cohn as a *Micrococcus*. There is considerable doubt whether any of these *Micrococci* are independent organisms; as it is certain that some of them are nothing else than sporules of *Bacteria* or *Bacilli* (Plate XII., figs. 1–3). But as some of them do not, under cultivation, develop themselves into any higher form, continuing to multiply as isolated cells by binary subdivision, they must for the present be ranked as distinct.<sup>3</sup>

305. *Bacteria* are minute oblong cells, which are usually seen attached in pairs end to end (Fig. 193, A, C), but not unfrequently present themselves singly (B, D), the pairs being produced by the self-division of solitary cells. They are usually seen in 'vacillating' movement, produced by the action of their *flagella*, of which, in their paired state, each cell bears one at its free extremity, whilst the solitary cells bear a flagellum at each extremity. The formation of the second flagellum seems to take place by the drawing-out of a filament of protoplasm be-

<sup>1</sup> "Beiträge zur Biologie der Pflanzen," Band i., Heft ii. (1872), and Heft iii. (1875); Band. ii., Heft ii. (1870).

<sup>2</sup> See especially Prof. E. Ray Lankester's account of 'A Peach-colored *Bacterium*,' in "Quart. Journ. Microsc. Science," Vol. xiii. (1873), p. 408; and Mr. J. C. Ewart 'On the Life-history of *Bacillus anthracis*,' in Vol. xviii. (1878), p. 161, of the same Journal.

<sup>3</sup> See Ewart in "Proceedings of Royal Society," June 20th, 1878.

tween two cells that are separating from each other (as in Fig. 196, a, b), the rupture of which gives a new flagellum to each. Two species of this type, differing considerably in size, have been especially studied. The cells of *Bacterium termo* (Fig. 193, A), which seem to be the 'ferment' of ordinary putrefactive change, have a diameter of about 1-20-000th of an inch, and are somewhat longer than they are broad. Their flagella are so minute as to be among the most 'difficult' of all Microscopic objects (p. 162); their diameter being estimated by Mr. Dallinger at no more than 1-200,000th of an inch.' Although this species does not

FIG. 193

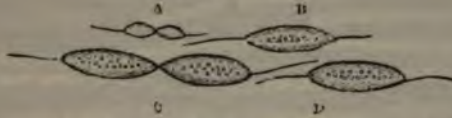

A, *Bacterium termo*, each cell furnished with a single flagellum: Magnified 4,000 diameters. B, C, D, *Bacterium lineola*, each cell when separated having a flagellum at either end. Magnified 3,000 diameters.

ordinarily multiply in any other way than by transverse subdivision, yet, under 'cultivation' at a temperature of 86° Fahr., its cells have been seen to elongate themselves into motionless rods, resembling those of *Bacilli* (Plate XII.), whose endoplasm breaks up into separate particles that are set free as small, bright, almost spherical spores, which sometimes congregate so as to form a *zoogloea*-film. These germinate into short, slender rods, which are at first motionless, but soon undergo transverse fission, and then acquire flagella.<sup>1</sup>—The *B. lineola*, which is the

FIG. 194.



A, *Bacillus subtilis*; each cell, when separated, biflagellate. Magnified 4,000 diameters. B, *Bacillus ulna*, each cell biflagellate. Magnified 3,000 diameters.

special 'ferment' that turns milk sour, occasioning the conversion of its sugar into lactic acid, has about three times the length and diameter of the preceding, and exhibits much stronger to-and-fro movements.

306. The special peculiarity of *Bacillus* consists in the extension of its cells into straight rods, sometimes of considerable length, which break-up by transverse subdivision into separate cells, each of which has a flagellum at either end, though, when the cells are paired (like those of *Bacteria*), each carries a flagellum at its free end alone. The *B. subtilis* (*Vibrio subtilis* of Ehrenberg), found in stale boiled milk that is undergoing the butyric fermentation, is a slender supple thread (Fig. 194, A), whose cells average about 1-5,000th of an inch in length, moving in a 'pausing' manner, "like a fish forcing its way through reeds." The *B. ulna* (Fig. 194, B), found by Cohn in a stale infusion of boiled egg,

<sup>1</sup> "Journ. of Roy. Microsc. Soc. Vol. i. (1878), p. 175.

<sup>2</sup> Ewart, *loc. cit.*

## PLATE XII.



## LIFE-HISTORY OF BACILLUS ANTHRACIS (after Ewart).

Fig. 1. Spores which have escaped from the filaments. 2. Division of spore into four sporules. 3. Sporules forming a zooglaea. 4, 5. Sporules developing into a rod, which at a divides into two segments. 6. A rod undergoing segmentation, and the segments showing flagella. 7. Rods with corpuscles (vacuoles or nuclei). 8. A newly-developed filament. 9. Filament in which the endoplasm has divided into somewhat long segments. 10. Further segmentation of a filament. 11. First appearance of spores as minute specks in the endoplasm near the ends of the segments. 12. Fully developed spores formed by contraction of the endoplasm. 13. Granular matters in spaces between spores, indicative of disintegration of filament. 14. Almost complete disappearance of filament. 15. Filament from which spores have escaped. 16. Filament broken into short segments, of which some still contain spores. 17. Filament still more disintegrated, with one of the spores, a, in process of division. 18. Rods forming a zooglaea. 19. Rod undergoing segmentation. 20. Rod lengthening into filament. 21. Filament containing spores becoming granular at one end, with transverse lines between spores. 22. Spore-bearing filaments forming rope-work. 23. Part of filament containing a spore in process of division. 24. Different stages of development of spore into rod. 25. Short filaments containing spores.



is distinguished from the preceding by the greater thickness of its filaments and by its rigidity. The *B. anthracis*, which is found in the blood and tissues of animals affected with carbuncle and splenic fever, usually presents itself in straight slender rods, of from 1-2,000th to 1-10-000ths of an inch in length (Fig. 195); these, so long as they are imbedded in living tissues, seem to multiply indefinitely by transverse division (Plate XII., 5, 6), thus continuing to produce short motile filaments, furnished with flagella, without extending themselves into longer filaments, or giving origin to spores. When, however, these are 'cultivated' at about the temperature of 90°, they lengthen-out (after alternations of rest and motion) into very long filaments (22), whose endoplasm divides into numerous segments (9), which may again divide (10, 11), and then rapidly contract to form spores (12, 13). These spores, escaping by the disintegration of the filaments (14, 17), and presenting themselves (1) as Micrococcus-forms, may either multiply as round or oval cells by binary subdivision (2), sometimes aggregating into a zooglæa (3); or they may at once develop themselves (4, 5) into the straight rods characteristic of the type. The sporuliferous filaments (20, 21) are often

FIG. 195.



Matted Rods of *Bacillus anthracis*, extending in rows between connective tissue-fibres of subcutaneous tissue.

very much smaller in diameter than the ordinary rods; and are disposed to break up and aggregate themselves either into an ordinary zooglæa (19), or into a double spiral rope-work (23).<sup>1</sup> It appears from Mr. Ewart's later observations<sup>2</sup> on a *Bacillus* from sea-water resembling *B. anthracis* in size and form, that by the continued subdivision and aggregation of the spores (or, possibly, by the emission of their contents), granular masses of considerable size are produced; the rupture of which by pressure diffuses over the field their component granules, every one of which seems capable, when placed in a drop of sea-water, of germinating into a rod. If, as seems probable, similar 'minimization' and multiplication of the reproductive germs takes place in *Bacteria* also (as it will be shown to do in the true *Monads* (§ 417), the idea of the universal diffusion of such germs through the atmosphere, which seems necessary to account for the phenomena of putrefaction (§ 310), should not be found difficult of acceptance.

307. The *Vibriones*, although very long known, have not been studied with the same completeness as other *Schizomycetes*. They resemble *Bacilla* in the slenderness of their forms; but instead of being straight and rod-like, are flexible, with more or less of S-shaped curva-

<sup>1</sup> See Ewart, *loc. cit.*

<sup>2</sup> "Proceedings of Royal Society," June 20th, 1878.

ture. They present themselves abundantly in infusions of decomposing organic matter, in combination with other Bacteria forms, from which they are distinguishable by their wavy serpentine movement. The length of one of the commonest species, *V. rugula* (Fig. 196), is usually from 1-1,200th to 1-2,500th of an inch.

FIG. 196

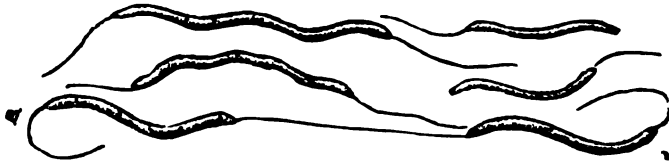

Four individuals of *Vibrio rugula*, each showing flagellum at one or both ends; two other individuals, *a* and *b*, separating from each other, and drawing out protoplasmic filament to their flagella. Magnified 2,000 diameter.

308. *Spirilla*, which are the largest of the whole group, are characterized by the spiral coiling of their cells (Fig. 197), and by their cork-screw-like movement; and are found not so much in newly decomposing infusions of organic matter, as in stale liquids which have passed through the active stages of putrescence. Nothing has been certainly known, until recently, of their life-history; but the observations of Messrs. Geddes and Ewart<sup>1</sup> seem to render it clear that they pass through a

FIG. 197.

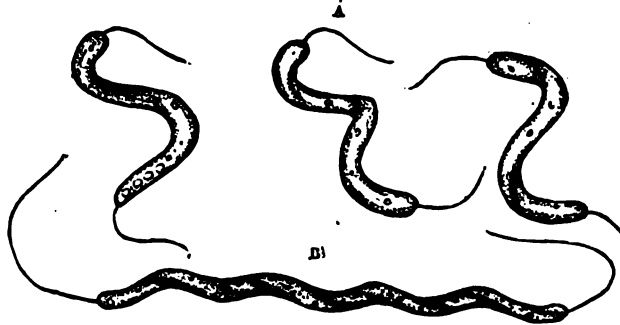

*A. Spirillum undula*, showing flagellum at each end. Magnified 3,000 diameters. *B. Spirillum volutans*. Magnified 2,000 diameters.

series of stages closely corresponding to those of Bacillus. The 'zooglæa' film formed by the aggregation of *Spirilla* has a brownish tint; some of the organisms of which it is composed are at rest, and others in rapid movement. The resting *Spirilla* are sometimes nearly straight, with a slight curvature at one or both ends, the curve increasing until the characteristic spiral of the motile form is attained; and the change from the still to the motile state may take place very rapidly, often with a passage through a transition *Vibrio* stage. But *Spirillum*, like the forms already described, may lengthen out into long filaments, which lose their characteristic twist and their motile powers; and their endoplasm breaks up into spores, which, after their escape from the filaments, form a distinct capsular investment, which holds them together in groups while multiplying by subdivision. Sometimes, again, a mere cellulose

<sup>1</sup> "Proceedings of Royal Society," June 20th, 1878.



envelope is formed, in which the spores lie irregularly imbedded, continuing to multiply by subdivision, so as to form large irregular masses. The development of the spore into a filament commences by the putting forth of a small curved prolongation, which gives it the shape of a comma; and as every possible gradation in size and form is seen between the smallest comma and the largest filament, there can be no reasonable doubt of the development of the former into the latter. Granular spheres are also seen, which may consist, like those of *Bacillus*, of minute particles emitted from the spores, and capable of development into a new generation of Spirilla.

309. Of the whole of this group it may be remarked that, so far as is yet known, they multiply either by transverse cell-division, or by the breaking up of their endoplasm into spores, the production of which is entirely non-sexual. Nothing like 'conjugation,' or any other form of sexual Generation, has yet been witnessed in any of them; and until such shall have been discovered, no confidence can be felt that we know the entire life history of any one type.<sup>1</sup>—It is a fact of great importance in the physiology of the *Schizomycetes*, that, in certain stages of their lives, they can resist both very high and very low temperatures without the loss of their vitality. In the active state of *Bacteria*, etc., they appear from the experiments of Dr. Eidam (which were conducted under the superintendence of Prof. Cohn) to be killed by continuous exposure to a temperature of 124° for three hours, or to 115° for thirteen or fourteen hours, although capable of sustaining a temperature of 120° for a short time without losing their vitality. But in the *Micrococcus*-stage, although killed by being boiled for a few minutes, they can sustain exposure to a dry heat of 230° Fahr., but are killed by being heated to 248°.<sup>2</sup> And this is probably the explanation of the fact, that Prof. Tyndall found that he could not sterilize an infusion of *old hay* (the *Bacteria* germs contained in which may be supposed to have had peculiarly dry hard envelopes) without boiling it continuously for several hours; though repeated short boilings with intervals of cooling would effectually destroy their power of germinating.<sup>3</sup> Even severe cold does not destroy the vitality of *Bacteria* and *Bacilli* in their ordinary condition, although it suspends their activity; for *Bacteria* have been found to recover themselves completely after exposure to a temperature of 0° Fahr.; and the spores of *Bacillus anthracis* have recovered their germinal power after exposure for several hours to a temperature averaging 8° below the zero of Fahrenheit.

310. When these facts are allowed their due weight, no difficulty ought to be felt in admitting the action of *Bacteria*, etc., in producing decomposition, under conditions which might at first view be fairly supposed to preclude the possibility of their presence. This action is altogether analogous to that of the Yeast-plant (§ 311) in producing saccharine fermentation; and the careful and exact experiments of Pasteur,<sup>4</sup> repeated and verified in a great variety of modes by Professors

<sup>1</sup> As it seems unquestionable that among the higher Fungi 'conjugation' often takes place at a very early stage of growth, it seems a not improbable surmise that the 'granular spheres' observed by Mr. Ewart in *Bacillus* and *Spirillum*, which seem to correspond with the 'microplasts' observed by Prof. E. Ray Lankester in his *Bacterium rubescens*, may be a product of conjugation in the *Micrococcus*-stage of these organisms.

<sup>2</sup> "Beiträge zur Biologie der Pflanzen," Heft 3 (1875).

<sup>3</sup> "Philosophical Transactions," 1877, p. 183.

<sup>4</sup> The experiments which have always seemed to the Author most satisfactory,



Lister, Tyndall, and others, seem to the writer to leave no reasonable doubt on these two points—(1) that putrefactive fermentation does not take place, even in liquids which are peculiarly disposed to pass into it, except in the presence of Bacteria-germs; and (2) that neither these germs, nor any others, arise in such liquids *de novo*, but that they are all conveyed into them by the air, when not otherwise introduced. Whether there are different species of *Bacteria*, *Bacillus*, etc., which (as maintained by some) excite distinct forms of disease respectively peculiar to them, in the bodies of animals into which they find their way, is a question which he thinks is scarcely yet ripe for decision. Strong evidence in its favor is afforded by the facts now accumulated in regard to the transmission of special forms of disease by inoculation, in some instances with *Bacillus* germs, and in others with very minute germinal particles termed *microzymes*, whose nature is still unknown. Thus 'splenic fever' is producible by the inoculation of *Bacillus anthracis*, and the typhoid fever of the pig by inoculation with another species of *Bacillus*,<sup>1</sup> the plants having been in both cases 'cultivated,' so as to be free from other contaminating matter. Again, it has been ascertained by careful microscopical examination of the fluid of the Vaccine vesicle, that it is charged with a multitude of minute granules not above 1-20,000th of an inch in diameter; and it has been further determined that these, rather than the fluid in which they are suspended, are the active agents in the production of a similar vesicle in the skin into which they are inserted. This vesicle must contain hundreds or thousands of 'microzymes' for every one originally introduced; and it is obvious that their multiplication has so strong an analogy to that of *Bacteria*, as to suggest the idea that it must take place by a like process of cell-development. Similar observations have been made upon Glanders, Sheep-pox, and Cattle plague; so that an animal suffering under either of these terrible diseases is a focus of infection to others, for precisely the same reason that a tub of ferment-

---

are those in which the careful *filtration* of the air (as by simply plugging the mouth of the tube or flask with cotton-wool), or its *purification* by the subsidence of the minute particles it ordinarily holds in suspension (as demonstrated by Prof. Tyndall's optical test), prevents any putrefactive change from taking place in organic liquids exposed to it. He would refer such as wish to study this important question, to the following papers in particular:—Prof. Huxley's Presidential Address to the British Association in 1870, reprinted in his "Critiques and Addresses;" Prof. Lister on 'Bacteria and the Germ-theory,' in "Quart. Journ. of Microsc. Science," Vol. xiii., p. 380, on 'The Nature of Fermentation' in vol. xviii. of the same Journal, p. 177, and his Address to the British Medical Association at Cambridge, in 'Brit. Med. Journ.,' 1880, p. 363; and Prof. Tyndall on 'The Optical Department of the Atmosphere in Relation to the Phenomena of Putrefaction and Infection,' in "Philos. Transact.," 1876, p. 27, and 'Further Researches' in "Philos. Trans.," 1877, p. 149; also, for an account of recent Pathological researches by Pasteur and others, 'Journ. of Roy. Microsc. Soc.,' vol. iii. (1880), pp. 1006-1020. The doctrines advanced on the other side in Dr. H. Charlton Bastian's "Beginnings of Life," do not, in his judgment, stand the test of rigid scrutiny.

<sup>1</sup>The dried blood of horses that had died in India of 'Loodiana fever,' having been sent to the Brown Institution, a crop of *Bacillus anthracis* was grown from it, which reproduced the disease in healthy animals.—The very important fact has been discovered at the same institution, that the 'brewers' grains' largely used as food for cattle, afford a soil which is peculiarly favorable for the growth and development of the spore-filaments of *Bacillus*; and thus an obvious explanation was given of an epidemic of anthrax in a previously uninfected district, destroying a large number of animals, all of which had been fed with 'grains' obtained from a particular brewery.

ing beer is capable of propagating its fermentation to fresh wort.<sup>1</sup>—A most notable instance of such propagation is afforded by the spread of the disease termed 'pebrine' among the Silkworms of the south of France; the mortality caused by it being estimated to produce a money-loss of from three to four millions sterling annually, for several years following 1853, when it first broke out with violence. It has been shown by microscopic investigation, that in silkworms strongly affected with this disease, every tissue and organ in the body is swarming with minute cylindrical corpuscles about 1-6,000th of an inch long; and that these even pass into the undeveloped eggs of the female moth, so that the disease is hereditarily transmitted. And it has been further ascertained by the researches of Pasteur, that these corpuscles are the active agents in the production of the disease, which is engendered in healthy silkworms by their reception into their bodies; whilst, if due precautions be taken against their transmission, the malady may be completely exterminated.

311. Nearly allied to the *Schizomycetes* in the simplicity of its character and in its 'zymotic' action, is the *Saccharomyces (Torula) cerevisiæ*; the presence of which in Yeast gives to it the power of exciting the alcoholic fermentation in saccharine liquids. When a small drop of yeast is placed under a magnifying power of 400 or 500 diameters, it is seen to contain a large number of globular or ovoid cells, averaging about 1-3,000th of an inch in diameter, for the most part isolated, but some-

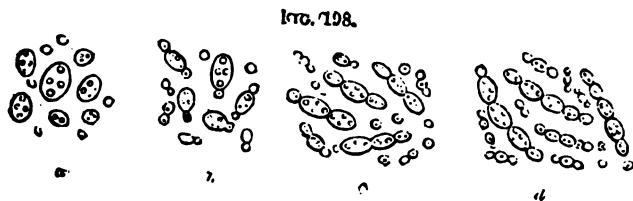

*Torula cerevisiæ*, or Yeast-plant, as developed during the process of fermentation:—a, b, c, d, successive stages of cell-multiplication.

times connected in short series; and each cell is filled with a nearly colorless 'endoplasm,' usually exhibiting one or more vacuoles, but never showing a nucleus. When placed in a fermentible fluid containing some form of nitrogenous matter in addition to sugar,<sup>2</sup> they vegetate, in the manner represented in Fig. 198. Each cell puts forth one or two projections, which seem to be young cells developed as buds or offsets from their predecessors; these, in the course of a short time, become complete cells, and again perform the same process; and in this manner the single cells of yeast develop themselves, in the course of a few hours, into rows of four, five, or six, which remain in continuity with each other whilst the plant is still growing, but which separate if the fermenting process be checked, and return to the isolated condition of those which originally constituted the yeast. Thus it is that the quantity of yeast first intro-

<sup>1</sup> See Prof. Burdon Sanderson 'On the Intimate Pathology of Contagion' in the Privy Council "Reports on the Public Health" for 1870

<sup>2</sup> It appears from the researches of Pasteur, that although the presence of Albuminous matter (such as is contained in a saccharine wort, or in the juices of fruits) favors the growth and reproduction of Yeast, yet that it can live and multiply in a solution of pure Sugar, containing ammonium-tartrate with small quantities of Mineral salts; the decomposition of the ammonia-salt affording it the nitrogen it requires for the production of protoplasm, while the sugar and water supply the carbon, oxygen, and hydrogen.

duced into the fermentible fluid, is multiplied six times or more during the changes in which it takes part. Under certain conditions not yet determined, the Yeast-cells multiply in another mode—namely, by the breaking-up of the endoplasm into segments, usually four in number, around each of which a new 'cell-wall' forms itself; and these *endogonidia* (which correspond with the 'zoöspores' of *Algæ*, save in having no motile power) being set free by the dissolution of the wall of the parent-cell, soon enlarge and comport themselves as ordinary Yeast-cells. No conjugation or other form of sexual action has yet been observed in *Torula*; and there are various reasons for surmising that we do not yet know its whole life-history.—Many other Fungi of like simplicity have the power to act as 'ferments:' thus in wine-making, the fermentation of the juices of the grapes or other fruit employed, is set going by the development of minute fungi whose germs have settled on their skins; these germs not being injured by desiccation, and being readily transported by the atmosphere in the dried-up state. There is reason to believe, moreover, that a similar 'zymotic' action may be excited by Fungi of a higher grade in the earlier stages of their growth; the alcoholic fermentation being set-up in a suitable liquid (such as an aqueous solution of cane-sugar, with a little fruit-juice) by sowing in it the sporules of any one of the ordinary 'moulds,' such as *Penicillium glaucum*, *Mucor*, or *Aspergillus*, provided the temperature be kept up to blood-heat; and this even though the solution has been previously heated to 284° Fahr., a temperature which must kill any germs it may itself contain.<sup>1</sup>

FIG. 290.

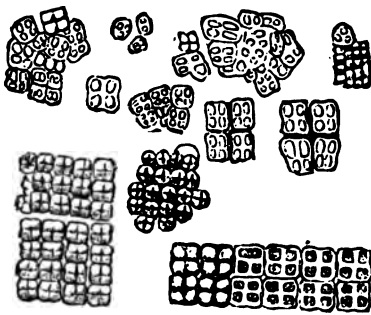
*Sarcina ventriculi*.

312. The *Sarcina ventriculi* (Fig. 199) is another Protophyte which seems related both to *Algæ* and *Fungi*; corresponding with the former in its aquatic habit and mode of growth, and with the latter in requiring organic matter of some kind for its sustenance. This Plant is most frequently found in the matters vomited by persons suffering under disorder of the stomach, but has also been met with in other diseased parts of the body. It has been detected in the contents of the stomach, however, under circumstances which seem to indicate that it is not an uncommon

tenant of that organ even in health, and that it may accumulate there to a considerable amount without producing any inconvenience. It seems probable, therefore, that its presence in disease is rather to be considered as favored by the changed state of the fluids which the disease induces (either an acid or a fermentible state of the contents of the stomach having been generally found to exist in the cases in which the plant has been most abundant), than to be itself the occasion of the disease, as some have supposed. The *Sarcina* presents itself in the form of clusters of adherent cells arranged in squares, each square containing from 4 to 64, and the number of cells being obviously multiplied by duplicative subdivision in directions transverse to each other. In fact, its

<sup>1</sup> See the observations of Mad. Lüders, in Schulze's "Archiv für Mikroskopische Anatomie," Band iii., abstracted in "Quart. Journ. Microsc. Sci.," N.S., vol. xiii. (1868), p. 35.



general mode of growth would indicate a near relation to *Gonium*, one of the *Volvocineae*, which presents itself in similar quadripartite aggregations; but there can be little doubt that, as no fructification has yet been seen in it, only its earlier and simpler condition is yet known to us; and its true place cannot be determined until its whole life-history shall have been followed out.

313. Another form of Fungous vegetation that develops itself within the living body, and which is of great economic importance as well as of scientific interest, is the *Botrytis bassiana* (Fig. 200), a kind of 'mould,' the growth of which is the real source of the disease termed *muscardine*,

FIG. 200

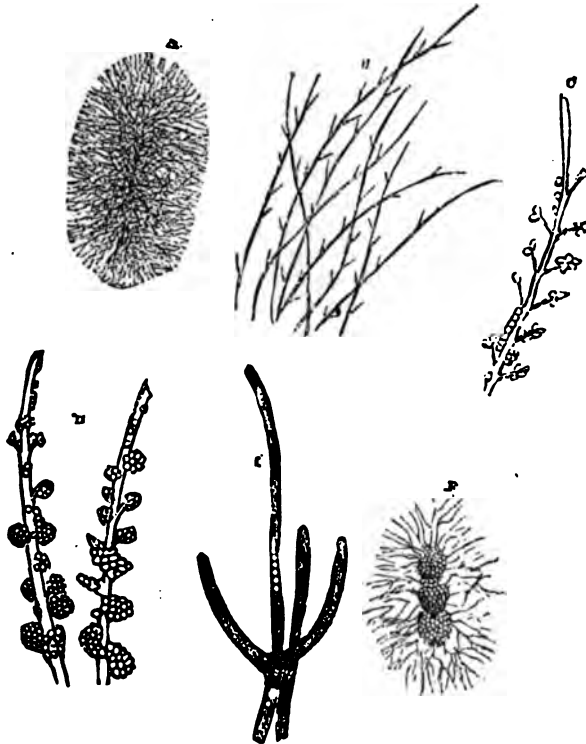

*Botrytis bassiana*.—A, the fungus as it first appears at the orifices of the stigmata; B, tubular filaments, bearing short branches, as seen two days afterwards; C, magnified view of the same; D, appearance of filaments on the fourth and sixth days; E, masses of mature spores falling off the branches, with filaments proceeding from them.

which formerly carried off Silk-worms in large numbers, just when they were about to enter the chrysalis state, to the great injury of their breeders. The plant presents itself under a considerable variety of forms (A-F), all of which, however, are of extremely simple structure, consisting of elongated or rounded cells, connected in necklace-like filaments, very nearly as in the ordinary 'bead-moulds.' The sporules of this fungus, floating in the air, enter the breathing-pores (Fig. 433) which open into the tracheal system of the Silkworm: they first develop themselves within the air-tubes, which are soon blocked up by their growth; and they then extend themselves through the fatty mass beneath the skin,

occasioning the destruction of this tissue, which is very important as a reservoir of nutriment to the animal when it is about to pass into its chrysalis condition. The disease invariably occasions the death of the worm which it attacks; but it seldom shows itself externally until afterwards, when it rapidly shoots-forth from beneath the skin, especially at the junction of the rings of the body. Although it spontaneously attacks only the larva, yet it may be communicated by inoculation to the chrysalis and the moth, as well as to the worm; and it has also been observed to attack other Lepidopterous Insects. A careful investigation of the circumstances which favor the development of this disease was made by Audouin, who first discovered its real nature; and he showed that its spread was favored by the overcrowding of the worms in the breeding establishments, and particularly by the practice of throwing the bodies of such as died into a heap into the immediate neighborhood of the living worms: for this heap speedily became covered with this kind of 'mould,' which found upon it a most congenial soil; and it kept up a continual supply of sporules, which, being diffused through the atmosphere of the neighborhood, were drawn into the breathing pores of individuals previously healthy. The precautions obviously suggested by the knowledge of the nature of the disease, thus afforded by the Microscope, having been duly put in force, its extension was successfully kept down.

314. An example of the like kind is frequently presented in the destruction of the common House-fly by a minute fungus termed *Empusa muscæ*. In its fully developed condition, the spore-bearing filaments of this plant stand out from the body of the fly like the 'pile' of velvet; and the spores thrown off from these in all directions form a white circle round it, as it rests motionless on a window-pane. The filaments which show themselves externally are the fructification of the fungus which occupies the interior of the Fly's body; and this originates in minute corpuscles which find their way into the circulating fluid from without. A healthy fly shut up with a diseased one, takes the disease from it by the deposit of a sporule on some part of its surface; for this, beginning to germinate, sends out a process which finds its way into the interior, either through the breathing-pores, or between the rings of the body; and having reached the interior cavity, it gives off the minute corpuscles which constitute the earliest stage of the *Empusa*.—Again it is not all uncommon in the West Indies, to see individuals of a species of *Polistes* (the representative of the Wasp of our own country) flying about with plants of their own length projecting from some part of their surface, the germs of which have been probably introduced (as in the preceding case) through the breathing-pores at their sides, and have taken root in their substance, so as to produce a luxuriant vegetation. In time, however, this fungous growth spreads through the body, and destroys the life of the insect; it then seems to grow more rapidly, the decomposing tissue of the dead body being still more adapted than the living structure to afford it nutriment.—A similar growth of different species of the genus *Sphæria* takes place in the bodies of certain caterpillars, in New Zealand, Australia, and China; and being thus completely pervaded by a dense substance, which, when dried, has almost the solidity of wood, these caterpillars come to present the appearance of twigs, with long slender stalks that are formed by the growth of the fungus itself. The Chinese species is valued as a medicinal drug.

315. The stomachs and intestines of many Worms and Insects are infested with parasitic Fungi, which grow there with great luxuriance. In

the accompanying illustrations (Figs. 201, 202) are shown some of the forms of the *Enterobryus*,<sup>1</sup> which has been found by Dr. Leidy<sup>2</sup> to be so constantly present in the stomach of certain species of *Iulus* (gally worm), that it is extremely rare to meet with individuals whose stomachs do not contain it. The *Enterobryus* originally consists of a single long tubular

cell, which sometimes grows in a spiral mode (Fig. 201); sometimes straight and tapering (Fig. 202, A). In its young state the cell contains a transparent protoplasm, with granules and globules of various sizes; but in its more advanced condition the tube of the filament is occupied by cells in various stages of development; these distend the terminal part of the cell (Fig. 202, B), and press so much against each other that their walls become flattened; whilst nearer the middle of the same filament (C) we find them retaining their rounded form, and merely lying in contact with each other; and at the base (D), they lie detached in the midst of the granular protoplasm. In *E. spiralis* the primary cells (Fig. 201, b, c) very commonly have secondary and even ternary cells (d) developed at their



Growth of *Enterobryus spiralis* from mucous membrane of stomach of *Iulus*: —a, epithelial cells of mucous membrane; b, spiral filament of enterobryus; c, primary cell; d, secondary cell.

extremities; but this is rarely seen in *E. attenuatus* (Fig. 202). It may be considered as next to certain that the tubular filaments rupture, when the contained cells have arrived at maturity, and give them exit; and that these cells are developed, under favorable circumstances, into tubular filaments like those from which they sprang; but the process has not yet been thoroughly made out. This is obviously not the true Generation of the plant, but is analogous to the development of zoöspores in *Achlya* (§ 250).—It is not a little curious; moreover, that the Entozoa or parasitic Worms infesting the alimentary canal of these animals should be often clothed *externally* with an abundant growth of such plants; in one instance, Dr. Leidy found an *Ascaris* bearing twenty-three filaments of *Enterobryus*, “which appeared to cause no inconvenience to the animal, as it moved and wriggled about with all the ordinary activity of the species.” The presence of this kind of vegetation seems to be related to the peculiar food of the animals in whose stomachs it is found; for Dr. Leidy could not discover traces of these or any other parasitic plants in the alimentary canal of the *carnivorous* Myriapods which he examined; whilst he met with a constant and most extraordinary profusion of vegetation in the stomach of a *herbivorous* Beetle, the *Passulus cornutus*, which lives like the Iuli, in stumps of old trees, and feeds as they do on decaying wood.

316. There are various diseased conditions of the Human skin and mucous membranes, in which there is a combination of fungoid Vegeta-

<sup>1</sup> This plant, also, has much affinity to Algae in its general type of structure, and is referred to that group by many botanists; but the conditions of its growth, as in the case of *Sarcina*, seem rather to indicate its affinity to the Fungi; and until its proper fructification shall have been made out, its true place in the scale must be considered as undetermined.

<sup>2</sup> “Smithsonian Contributions to Knowledge,” Vol. v.



tion and morbid growth of the Animal tissues: this is the case, for example, with the *Tinea favosa*, a disease of the scalp, in which yellow crusts are formed that consist almost entirely of the mycelium, receptacles, and sporules of a fungus; and the like is true also of those white patches (*Aphthæ*) on the lining membrane of the mouth of infants, which are known as *thrush*, and of the exudations of 'false membrane' in the disease termed *diphtheria*. In these and similar cases, two opinions are entertained as to the relation of the Fungi to the diseases in which they present themselves: some maintaining that their presence is the essential condition of these diseases, which originate in the introduction of the vegetable germs; and others considering their presence to be secondary to some morbid alteration of the parts wherein the fungi appear, which alteration favors their development. The first of these doctrines derives a strong support from the fact, that the diseases in question may be communicated to healthy individuals, through the introduction of the germs of the Fungi by inoculation; whilst the second is rather consistent with general analogy, and especially with what is known of the conditions

FIG. 202.

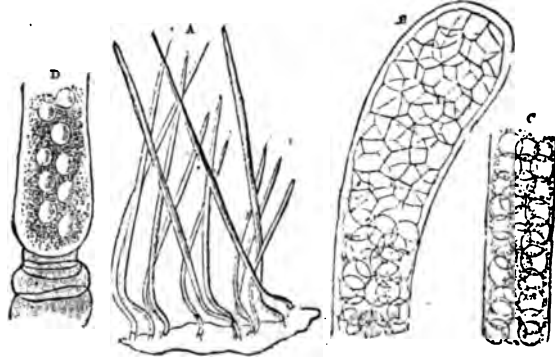

Structure of *Enterobryus*.—A, growth of *E. attenuatus*, from mucous membrane of stomach of *Passulus*; B, dilated extremity of primary cell of *E. elegans*, filled with secondary cells, which, near its termination, become mutually flattened by pressure; C, lower portion of the same filament, containing cells mingled with granules; D, base of the same filament, containing globules interposed among granules.

under which the various kinds of fungoid 'blights' develop themselves in or upon growing Plants (§ 320).—It is not a little remarkable that even Corals, Shells, Fish-scales, and other hard tissues of Animals, are not un-frequently penetrated by fungous Vegetation, which usually presents itself in the form of simple tubes more or less regularly disposed (Fig. 203), and closely resembling those of an ordinary *mycelium* (compare Fig. 207, a), but occasionally exhibits a distinct fructification that enables its true character to be recognized.<sup>1</sup>

<sup>1</sup> See Professor Kölliker 'On the Frequent Occurrence of Vegetable Parasites in the Hard Tissues of Animals,' in "Quart. Journ. of Microsc. Science," Vol. viii. (1860), p. 171.—Previously to the publication of his friend Prof. K.'s paper, the Author had himself arrived at a similar conclusion in regard to the parasitic nature of many of the tubular structures which had been originally regarded not merely by himself, but by Prof. Kölliker, as proper to the Shells in which they occur.—Prof. Duncan has recognized like parasitic growths, apparently allied to *Achlya*, § 250 (which is now ranked by many among Fungi), both in recent and Fossil Corals. See "Proceed. of Roy. Soc.," Vol. xxv. (1879), p. 238; and "Quart. Journ. Geolog. Soc.," Vol. xxxii., p. 205.

317. There are scarcely any Microscopic objects more beautiful than some of those forms of 'mould' or 'mildew,' which are commonly found growing upon the surface of jams and other preserves; especially when they are viewed with a low magnifying power, by reflected light. For they present themselves as a forest of stems and branches, of extremely varied and elegant forms (Fig. 204), loaded with fruit of a singular delicacy of conformation, all glistening brightly on a dark ground. In removing a portion of the 'mould' from the surface whereon it grows, for the purpose of microscopic examination, it is desirable to disturb it no more than can be helped, in order that it may be seen as nearly as possible in its natural condition; and it is therefore preferable to take up a portion of the membrane-like substance whereon it usually rests, which is, in fact, a *mycelium* composed of interlacing filaments of the *vegetative* part of the plant, the stems and branches being its *reproductive* portion (§ 321).—The universality of the appearance of these simple forms of Fungi upon all spots favorable to their development, has given rise to the belief that they are spontaneously produced by decaying substances: but there is no

FIG. 203.

Shell of *Anomia* penetrated by Parasitic Fungus.

FIG. 204.

*Styxanus caput-medusæ*.

occasion for this mode of accounting for it; since the extraordinary means adopted by Nature for the production and diffusion of the germs of these plants adequately suffice to explain the facts of the case. The number of sporules which any one Fungus may develop is almost incalculable; a single individual of the puff-ball tribe has been computed to send forth no fewer than ten millions. And their minuteness is such that they are scattered through the air in the condition of the finest possible dust; so that it is difficult to conceive of a place from which they should be excluded. This universal diffusion was clearly proved several years ago by an experiment made by Dr. Brittan, of Bristol; who caused air to be pumped for several hours together through an inverted siphon, the bend of which was immersed in a freezing mixture, so as to condense the aqueous vapor of the atmosphere. The water at last came to be tinged of a deep brown hue; and was found, when microscopically examined, to be charged with multitudes of sporules of Fungi. More recently, Prof. Tyndall has shown, by a peculiar application of electric light, that all ordinary air contains a multitude of excessively minute solid particles suspended in it; that these, being for the most part destructible by heat, are chiefly organic; and that they may be either strained off, so as to ren-

der the filtered air "optically pure," by passing it through cotton wool, or may be got rid of by allowing them time to subside in a closed chamber whose bottom is smeared with glycerine, so that they are held down when once they have settled on it.

318. This mode of explanation has received further confirmation from the facts recently ascertained, in regard to the great number of forms under which a single germ may develop itself. For it has been ascertained with regard to the Fungi generally, that different individuals of the same species may not only develop themselves in very dissimilar modes, but may even bear dissimilar types of fructification; and further, that even the same individual may put forth, at different periods of its life, those two kinds of fructification—the *Basidio-sporous*, in which spores are developed by outgrowth from free points (*basidia*), and the *Ascomycetous*, in which they are developed in the interior of cases (*theca* or *asci*, Fig. 205)—which had been previously considered as separately characterizing the two principal groups into which the Class was primarily divided. But the spores produced from the *ostensible* 'fructification' in this Class are all non-sexual or *gonidial* (§ 228). In a large proportion of it, nothing whatever is known of the true *Generative* process; and wherever it has been detected, it is performed in a manner that carries us back to the simplicity of the lower Algal types.—Thus the *mycelium* of the common *Mucor* which forms the 'brown mould' of bread, preserves, etc., consists of a single cell, which first sends forth wide-spreading branches that extend over the surface on which it grows, and then develops a vertical pin-like stem, enlarging at its top a little globular 'head,' the cavity of which is cut off from that of the stem by a partition, so as to form a separate 'sporangial' cell, whose endoplasm breaks up into a number of 'micro-gonidia;' and every one of these, when set free by the bursting of the sporangium, can give origin to a new mycelium. But the Generative act is performed in the mycelium itself; two branches of which, coming into contact with each other at their free extremities, there form separate terminal cells, the fusion of which unites their two endoplasm into one (just as in the conjugation of *Mesocarpus*, § 235); and this, surrounding itself with a thick cell-wall, becomes an 'oospore,' which may remain a long time in the dry state without germinating. It is by the formation of *gonidia* that a 'mould' whose germ has fallen upon a fruitful soil rapidly extends itself over a large surface; whilst the carrying of the *oospores* by currents of air forms the chief means of its transmission to a distance.—The *Penicillium*, or 'green mould,' on the other hand, sends-up from its mycelium a branching stem, the ramifications of which subdivide into a brush-like tuft of filaments, each of which bears at its extremity a succession of minute 'beads' termed *conidia*. These, detaching themselves and falling on a suitable soil, forthwith germinate into new mycelia; or, drying up, are disseminated by atmospheric currents, without loss of their vitality. Here, again, the Generative act is performed in the mycelium; but by a somewhat more complex apparatus than in *Mucor*. One of its branches elongates, and coils spirally upon itself into a corkscrew-like body, the *ascogonium*, which constitutes the female organ; whilst another branch acts as the male organ, the *pollinodium*, which extends itself over the spire, and communicates to its endoplasm some fertilizing material from its own. The germ thus formed becomes inclosed in a mass of sterile tissue; and within this it develops itself into a cluster of *asci*, each containing numerous spores, whose liberation gives origin to a 'new generation.'



319. The 'entophytic' Fungi which infest some of the Vegetables most important to Man as furnishing his staple articles of food, constitute a group of special interest to the Microscopist; of which a few of the chief examples may be here noticed. The *mildew* which is often found attacking the straw of Wheat, shows itself externally in the form of circular clusters of pear-shaped *asci* or spore-cases (Fig. 205), each containing two compartments filled with sporules; these (known as the *Puccinia graminis*) arise from a filamentous tissue constituting its *mycelium*, the threads of which interweave themselves with the tissue of the straw; and they generally make their way to the surface through the 'stomata' or breathing-pores of its epidermis. The *rust*, which makes its appearance on the leaves and chaff-scales of Wheat, has a fructification that seems essentially distinct from that just described, consisting of oval spore-cases, which grow without any regularity of arrangement from the threads of the mycelium, and hence it has been considered to belong to a different genus and species, *Uredo rubigo*. But from the observations of Prof. Henslow, it seems certain that 'rust' is only an earlier form of 'mildew;' the one form being capable of development into the other, and the fructification characteristic of the two supposed genera having been evolved on one and the same individual.—It is another reputed species of *Uredo* (the *U. segetum*), which, when it attacks the flower of the wheat, reducing the ears to black masses of sooty powder, is known as *smut* or *dust-brand*. The corn-grains are entirely replaced by aggregations of spores; and these, being of extreme minuteness, are very easily and very extensively diffused. The *bunt* or *stinking rust* is another species of *Uredo* (the *U. foetida*), which is chiefly distinguished by its disgusting odor.

320. The prevalence of these Blights to any considerable extent seems generally traceable to some seasonal influences unfavorable to the healthy development of the cereal; but they often make their appearance in particular localities through careless cultivation, or want of due precaution in the selection of seed. It may be considered as certain that an admixture of the spores of any of these Fungi with the corn grains will endanger the plant raised from them; but it is equally certain that the fungi have little tendency to develop themselves in plants that are vegetating with perfect healthfulness. The wide prevalence of such blights in bad seasons is not difficult to account for, if it be true (as the observations of Mr. John Marshall several years since rendered probable) that there are really *very few* wheat-grains, near the points of which one or two sporules of Fungi may not be found, entangled among their minute hairs; and it may be fairly surmised that these germs remain dormant, unless an unfavorable season should favor their development by inducing an unhealthy condition of the wheat-plant.—The same general doctrine probably applies to the *Peronospora*, which has a large share in the production of the "Potato-disease;" and to the *Oidium*, which has a like relation to the "Vine-disease" that was prevalent for some years through the south of Europe. There seems no doubt, that in the fully developed disease, the Fungus is always present; and that its growth and

FIG. 205.



Puccinia graminis, or Mildew.

multiplication have a large share in the increase and extension of the disorder, just as the growth of the Yeast-plant excites and accelerates fermentation; while its reproduction enables this action to be indefinitely extended through its instrumentality. But just as the Yeast-plant will not vegetate save in a fermentible fluid—that is, in a solution which, in addition to sugar, contains some decomposable nitrogenous matter—so does it seem probable, on consideration of all the phenomena of the Potato and Vine diseases, that neither the *Peronospora* of the one nor the *Oidium* of the other will vegetate in perfectly healthy plants; but

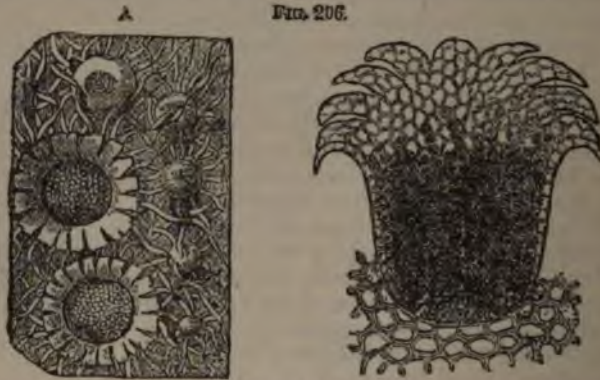

*Ecidium tussilaginis*:—A, portion of the plant magnified; a, section of one of the conceptacles with its spores.

that a disordered condition, induced either by forcing and therefore unnatural systems of cultivation, or by unfavorable seasons, or by a combination of both, is necessary as a 'predisposing' condition. This condition, in the case of the Potato-disease, is said by Prof. De Bary to consist in an undue thinness of the cuticle, accompanied by excessive humidity; whereby the sporules of the fungus will germinate on the

FIG. 207.



*Clavaria crispula*:—a, portion of the mycelium magnified.

surface of the plant, sending out processes which penetrate to its interior, though otherwise germinating only on cut surfaces.

321. In those lower forms of this Class which have been now described, there is not usually any complete separation between the Nutritive or vegetative, and the Reproductive portions of the fabric. But such a separation makes itself apparent in the higher; and this in a very curious mode. For the ostensible Fungi, known as Mushrooms, Toadstools, Puff-balls, etc., consist, in fact, of nothing else than the organs of gonidial fructification (Fig. 260), inclosing an enormous mass of non-



sexual spores; while the *nutritive* apparatus of these plants is composed of an indefinite *mycelium*, which is a filamentous expansion (Fig. 207, *a*), composed of elongated branching cells interlacing amongst each other, but having no intimate connection; and this has such an indefiniteness of form, and varies so little in the different tribes of Fungi, that no determination of species, genus, or even family, could be certainly made from it alone. A true Generative process has not hitherto been detected with certainty in these higher Fungi, although it has been supposed by some observers to be carried on in the *mycelium*. And their Life-history needs now to be carefully restudied, with all the assistance derivable

FIG. 208.



Development of *Myxomycetes*:—A, plasmodium of *Didymium serpula*;—B, successive stages, *a, a', b*, of sporosacs of *Arcyria flava*;—C, ripe spore of *Physarum album*; D, its contents escaping; E, F, G, the swarm-spore first becoming flagellated, and then amoeboid; H, conjugation of two amoeboids, which at I have fused together, and at J are beginning to put out extensions and ingest nutriment, of which two pellets are seen in its interior.

from our increased knowledge of the simpler types of the group, and with the skill which can only be acquired by considerable practice in Microscopical investigation.—The subject, however, is one of such peculiar *speciality*, that it cannot be advantageously pursued further in a Treatise like the present.

322. Many eminent Botanists still rank in the *Fungal* series of Protophytes a very peculiar group, the *Myxomycetes*, the members of which pass a large part of their lives in a state of what can scarcely be otherwise described than as one of *Animal* existence. They grow parasitically



upon decayed wood, bark, heaps of decaying leaves, tan-beds, etc.; spreading over damp surfaces as a *plasmodium*, or network of naked protoplasmic filaments (Fig. 208, A), of a soft creamy consistence, and usually of a yellowish color. The filaments of this network exhibit active undulatory movements, which in the larger ones are visible under an ordinary lens, or even to the naked eye, but which it requires microscopic power to discern in the smaller. With sufficiently high amplification, a constant movement of granules may be seen flowing along the threads, and streaming from branch to branch. Here and there offshoots of the protoplasm are projected, and again withdrawn, in the manner of the pseudopodia of an *Amœba*; while the whole organism may be occasionally seen to abandon the support over which it had grown, and to creep over neighboring surfaces, thus far resembling in all respects a colossal ramified *amœba*. It is also curiously sensitive to light, and may sometimes be found to have retreated during the day to the dark side of the leaves or into the recesses of the tan over which it had been growing, and again to creep out on the approach of night.—After a time there arise from the surface of this *plasmodium* oval capsules or sporangia (B, a, a', b), within which the reproductive bodies or 'spores' are developed, and which burst when mature to give them exit. Each 'spore' is a spherical cell (c) inclosed in a delicate membranous wall; and when it falls into water this wall undergoes rupture (D) and an *Amœba*-like body (E) escapes from it, consisting of a little mass of protoplasm, with a round central nucleus inclosing a nucleolus, and a contractile vesicle. This soon elongates (F), and becomes pointed at one end, whence a long *flagellum* is put forth, the lashing action of which gives motion to the body. After a time, the flagellum disappears, and the active movements of the spore cease; but it now begins to put forth and to withdraw finger-like pseudopodia, by means of which it creeps about like an *Amœba*, and feeds, like that *Rhizopod*, upon solid particles which it engulfs within its soft protoplasm. A 'conjugation' then takes place between two of these *Myxamœbæ* (H), their substance undergoing a complete fusion into one body (I), from which extensions are put forth (K), that constitute the beginning of a new plasmodium. This continues to grow by the ingestion and assimilation of the solid nutriment which it takes into its substance; and, by the ramification and inosculation of these extensions, a network is formed resembling that from which it originated, to bear sporangia in its turn, from which a new cycle will commence.

323. Under certain conditions not yet perfectly understood, the *Myxomycetes* have been observed to pass from the active into the 'resting' state; and this may occur both in the amœboid spores and in the plasmodium. The former return to the spherical form, and surround themselves with a firm envelope; and in this 'encysted' condition they may be dried-up so as to be carried about as dust, resuming their original activity when again placed in water. When the plasmodium is about to pass into the 'resting' state, it withdraws its finer branches, and expels such solid ingesta as may be included in it; and its motions then gradually cease. It then either breaks up into a multitude of polyhedral cells (?), which, however, remain connected in one body, that dries into a horny brittle mass termed 'sclerotium'; or separates into a number of fragments of unequal size, which take a spherical form and become 'encysted' in a double envelope. Both these 'resting' forms may undergo desiccation without the loss of their vitality. When, after

many months, the dry sclerotium is placed in water, it swells up, and its cells (?) again flow together into a protoplasmic mass, which soon resumes its former life as a *plasmodium*. So when the thick-walled cysts, after being long desiccated, are placed in water, their cysts rupture, and their protoplasmic bodies issue forth, to lead the life of *Amœba*, and to form fresh plasmodia, either by themselves, or by fusion with other like bodies.<sup>1</sup>

324. Another most interesting connecting link between the Vegetable and Animal kingdoms, is an organism discovered by Mr. W. Archer<sup>2</sup>—sometimes *within* the leaf-cells of *Sphagnum* (§ 329), and sometimes attached to the surface of its leaves—to which he has given the name of *Chlamidomyxis labyrinthuloides* (Fig. 209). In its early condition, whilst still inhabiting the *Sphagnum*-cells, this parasite resembles a large thick-walled Vegetable cell, with either green or red cell-contents; and is found to consist of a firm many-layered envelope which shows a distinctly-cellulose reaction, inclosing a colorless hyaline substance, through which a great multitude of granules are dispersed, some of them of a bright red, and others of a yellowish-green color,—the numbers of the two bearing so constant an inverse proportion to each other, as to make it likely that the red are produced by a color-change in the green. If this state alone were known to us, we should have no hesitation in regarding the organism as a *Vegetable cell*, the 'endoplasm' of which consists of protoplasm with chlorophyll-granules dispersed through it. But as it augments in size, it produces a bulging of the wall of the *Sphagnum*-cell, by the rupture of which it makes its way to the surface; and a new stage in its history then commences. Though the many-layered cellulose wall is so firm as to resist a considerable amount of external pressure, it bursts open from within, and the endoplasm then streams forth, carrying with it its imbedded granules. The protoplasmic trunk, almost directly that it leaves the cell-cavity, begins to subdivide into branches, from which others are put forth; and by this continued ramification and the inosculation of the offshoots, an extended network is formed, consisting of threads of extreme tenuity. In constant motion along these are seen minute fusiform particles of a bluish-green color, which are obviously identical with the round granules of the central mass, these changing their shape as they go forth to wander along the filaments. Sometimes the protoplasm accumulates in particular spots, forming 'islands' (*a, a*), each of which may become a centre of fresh radiation for hyaline threads. These accumulations frequently take place round *Diatoms*, *Desmids*, or other minute Vegetable organisms (*b*); which, being thus imbedded in the extensions of the protoplasmic body, are drawn towards it by their retraction, and at last engulfed within it. It would appear that the whole of the protruded endoplasm may be retracted into the original cell-cavity, and that this may be closed up again by the forma-

<sup>1</sup> The very peculiar history of the *Myxomycetes* (previously known as *Myxogastric Fungi*) was first investigated by De Bary, who was disposed to regard them as Animals ('Die Mycetozoen,' in "Zeitschr. f. w. Zool.," Bd. x., 1860). The subject was taken up by Cienkowski, the results of whose careful study of it will be found in his admirable Memoirs, 'Zur Entwicklungsgeschichte der Myxomyceten,' in Pringsheim's "Jahrbücher," Bd. iii. (1863), pp. 325, 400, and 'Ueber einige Rhizopoden und verwandte Organismen,' in "Archiv f. Mikr. Anat.," Bd. xii. (1876) p. 15; and he also is disposed to rank this group in the Animal kingdom. On the other hand, Prof. Sachs and other high Botanical authorities continue to rank it among Fungi.

<sup>2</sup> "Quart. Journ. of Microsc. Science," Vol. xv. (1875), p. 107.

tion of a new layer of cellulose within the old; for the indigestible parts of various organisms, that must have been introduced in the manner just described, are often distinguishable through the walls of completely closed-in specimens. Mr. Archer has been unable to detect a 'nucleus,' either in the body of his *Chlamidomyxis*, or in any of its extensions; but 'contractile vacuoles,' executing pretty regular rhythmical movements are to be seen, not only in the body and primary stem (in which they are usually very numerous), but also in the branches, and not

FIG. 269.



*Chlamidomyxis labyrinthoides*.—showing the protoplasmic mass extending itself from the ruptured cellulose envelope, and forming a network whose threads are traversed by fusiform particles; *a, a*, isolated masses of protoplasm; *b*, a captured *Navicula* about to be drawn into the protoplasmic mass.

unfrequently in the 'islands' also. Thus in its extended condition this creature leads a life which is essentially *Animal*, corresponding in every particular with that of the 'reticularian' *Rhizopods* hereafter to be described (Chap. x).—Nothing is yet known of its Reproduction. Mr. Archer has met with large individuals, the contents of whose many-layered cellulose wall had divided itself into a number of smaller orange-



colored spheres, of nearly equal size, each of which had its own cellulose wall; and it can scarcely be doubted that on the escape of these from the parent cyst, each would lead an independent life resembling that of its progenitor. It seems probable, moreover, that the outlying masses of the protoplasmic extension may detach themselves and live independently, each forming a cellulose envelope for itself.—But until ‘conjugation’ or some other kind of sexual union shall have been discovered in this curious organism, we cannot be said to know its whole life-history; and the peculiar interest which attaches to it renders the further study of it in the highest degree desirable. It may be hoped that the excellent observer by whom it has been brought to our knowledge, may ere long find himself able to supply the missing link.

325. LICHENS.—The Microscopic study of this group has latterly acquired a new interest for the Botanist, from the remarkable discovery announced in its complete form by Schwendener in 1869<sup>1</sup> (and now accepted by the highest authorities) that instead of constituting a special type of *Thallophytes*, parallel to *Algæ* (with which they correspond in their *vegetative* characters) and *Fungi* (to which they are more allied in *fructification*), they are really to be regarded as *composite* structure, having an Algal base, on which *Ascomycetous Fungi* (§ 318) have sown themselves and live parasitically. As, however, they do not furnish objects of interest to the ordinary Microscopist (the peculiar density of their structure rendering a minute examination of it more than ordinarily difficult), nothing more than a general account of their curious organization will here be attempted.—The Algal ‘thallus’ of a Lichen belongs to the group of *Parmellaceæ* (§ 243) or its allies; and consists of cells termed *gonidia*—usually green, but sometimes red or bluish-green—interspersed among long cellular filaments. The proportion between these two components of the thallus varies in different examples of the type. Thus, in the simplest Wall-lichens, the *Parmella*-like ‘primordial cell’ gives origin, by the ordinary process of cell-division, to a single layer of cells, which spreads itself over the stony surface in a more or less circular form; and the ‘thallus,’ which increases in thickness by the formation of new layers upon its free surface, has no very defined limit, and, in consequence of the slight adhesion of its components, is said to be ‘pulverulent.’ But, in the more complex forms of Lichens, the thallus is mainly composed of long fibre-cells, which dip down into the superficial layers of the bark of the trees on which they grow, and form by their interweaving a hard crustaceous ‘thallus’ in which the *gonidia* are imbedded, sometimes irregularly, sometimes in definite layers, covered by an envelope of interlacing filaments. It is from this Algal portion of the structure, that the *soredia* of Lichens are formed; which are little projections of the surface, composed of single or aggregate *gonidia*, invested by fibre-cells, and falling, when dry, into a powder, of which every particle is a bud, capable of reproducing the plant from which it proceeded.

326. The *fructification* of Lichens, on the other hand, is really the production of their Fungal overgrowths, which are nourished by the Algal vegetation. The Lichen-forming Fungi, in fact, live upon their Algal hosts, like the Entophytic Fungi (such as the ‘blights’ of corn, § 219) which infests the higher forms of Vegetation; each of the former

<sup>1</sup> See his memorable work “Ueber die Algentypen der Flechtengonidien” (Basel, 1869), which is said by Prof. Sachs (“Text-book of Botany,” p. 273) to have settled for the future the place of Lichens among the *Ascomycetes*, and Sir J. D. Hooker’s Presidential Address to the Royal Society, 1878.



## CHAPTER VIII.

## MICROSCOPIC STRUCTURE OF HIGHER CRYPTOGAMIA.

327. FROM the simple Protophytes, whose minuteness causes their entire fabrics to be fitting objects for Microscopic examination, we pass to those higher forms of Vegetable life whose larger dimensions require that they should be analyzed (so to speak) by the examination of their separate parts. And in the present Chapter we shall bring under notice some of the principal points of interest to the Microscopist which are presented by the *Cryptogamic* series; commencing with those simpler Algæ which scarcely rank higher than some of the Protophytes already described, and ending with the ferns and their allies, which closely abut upon the *Phanerogamia* or Flowering Plants. In ascending this

series, we shall have to notice a *gradual differentiation* of organs; those set apart for Reproduction being in the first place separated from those appropriated to Nutrition; while the principal parts of the Nutritive apparatus, which are at first so blended into a uniform expansion or *thallus* that no real distinction exists between root, stem, and leaf, are progressively evolved on types more and more peculiar to each respectively, and have their functions more and more limited to themselves alone. Hence we find a 'differentiation,' not merely in the external form of organs, but also in their intimate structure; its degree bearing a close correspondence to the degree in which their functions are respectively *specialized* or limited to particular actions. But this takes place by very slow gradations; a change of external form often showing itself, before there is any decided differentia-

tion either in structure or function. Thus in the simple *Ulva* (Fig. 144), whatever may be the extent of the thallus, every part has

FIG. 210

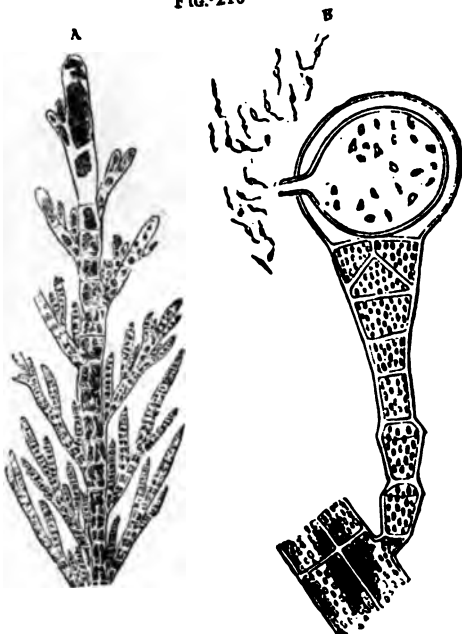

A, Terminal portion of branch of *Sphaeraria cirrhosa*; B, lateral branchlet of *S. Tribuloides*, the terminal cell of which is emitting antherozoids.



exactly the same structure, and performs the same actions, as every other part; every part is not used alike. And though, when we pass to the higher Strawberries, such as the common *Fragras* and *Lactuca*, we observe a certain blending of the distinction between Root, Stem, and Leaf, this connection is very imperfectly carried out; the root-like and stem-like portions serving for purposes other than the mechanical attachment of the plant to earth, and each still absorbing and assimilating its own nutriment, so that the transmission of fluid takes place from one part to another, not by the same means. There is not yet any



There is not yet any departure from the simple structure; the only modification being that the several layers of cells, where many exist, are of different sizes and shapes, the centre being usually closer together, and looser within; and that the texture of the stem and roots is looser than that of the leaf-expansions or fronds. The genus *Alismospermum*, or the common sea-weed, which in the genus *Fragras* exhibits the same kind of Aquatic structure, is the one with the lowest in the animal kingdom, which, notwithstanding, contains some of the most singular structures that are anywhere to be found in the group. The genus, of which we can only see a specimen in the Microscope, is *Alismospermum*, for example, which is a small and delicate sea-weed, which is very common, and parasitic upon the rocks, and flourishes in low-water pools, and is a common submerged plant. The following remarks are taken from the description of its symmetry that is given by the individual in the description of it, &c. The ends of the fronds have a layer of cells, which consists in the middle of a single row, which is the same as that which is seen in the fronds with the termination of the fronds, which is propagated in all directions, and is seen in many of the specimens that have been collected.

There is not yet any departure from the simple structure; the only modification being that the several layers of cells, where many exist, are of different sizes and shapes, the centre being usually closer together, and looser within; and that the texture of the stem and roots is looser than that of the leaf-expansions or fronds. The genus *Alismospermum*, or the common sea-weed, which in the genus *Fragras* exhibits the same kind of Aquatic structure, is the one with the lowest in the animal kingdom, which, notwithstanding, contains some of the most singular structures that are anywhere to be found in the group. The genus, of which we can only see a specimen in the Microscope, is *Alismospermum*, for example, which is a small and delicate sea-weed, which is very common, and parasitic upon the rocks, and flourishes in low-water pools, and is a common submerged plant. The following remarks are taken from the description of its symmetry that is given by the individual in the description of it, &c. The ends of the fronds have a layer of cells, which consists in the middle of a single row, which is the same as that which is seen in the fronds with the termination of the fronds, which is propagated in all directions, and is seen in many of the specimens that have been collected.

commonest of all, *F. vesiculosus* (bladder-wrack), they are limited to different individuals. When a section is made through one of the flattened receptacles of *F. platycarpus*, its interior is seen to be a nearly globular cavity (Fig. 211), lined with filamentous cells, some of which are

greatly elongated, so as to project through the pore by which the cavity opens on the surface. Among these are to be distinguished, towards the period of their maturity, certain filaments (Fig. 212, A), whose granular contents acquire an orange hue, and gradually shape themselves into oval bodies (B), each with an orange-colored spot, and two long thread-like appendages, which, when discharged by the rupture of the containing cell, have for a time a rapid undulatory motion, whereby these 'antherozoids' are diffused through the surrounding liquid. Lying amidst the filamentous mass, near the walls of the cavity, are seen

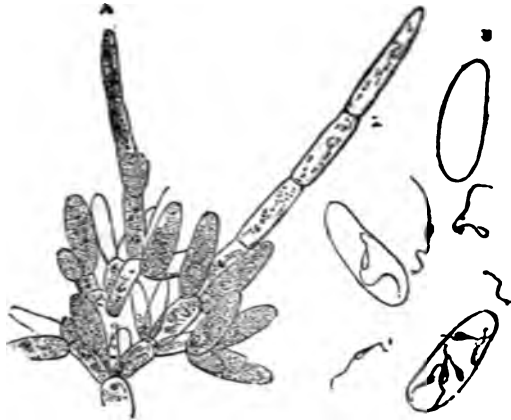

Antheridia and antherozoids of *Fucus platycarpus*:—A, branching articulated hairs, detached from the walls of the receptacle, bearing antheridia in different stages of development; B, antherozoids, some of them free, others still included in their antheridial cells.

(Fig. 211) numerous dark pear-shaped bodies, which are the *oögonia*, or parent-cells of the 'germ-cells.' Each of these *oögonia* gives origin, by binary subdivision, to a cluster of eight germ-cells or *oöspheres*, which is thence known as an 'octospore;' and these are liberated from their envelopes before the act of fertilization takes place. This act consists in the swarming of the antherozoids over the surface of the *oöspheres*, to which they communicate a rotatory motion by the vibration of their own filaments. In the hermaphrodite *Fuci* it takes place within the receptacles, so that the *oöspheres* do not make their exit from the cavity until after they have been fecundated; but in the monöcious and diöcious species, each kind of receptacle separately discharges its contents, which come into contact on their exterior. The antheridial cells are usually ejected entire, but soon rupture so as to give exit to their filaments; and the 'octospores' separate into their component *oöspheres*, which, meeting with antherozoids, are fecundated by them. The fertilized *oöspheres* soon acquire a new and firmer envelope; and, under favorable circumstances, they speedily begin to develop themselves into new plants. The first change is the projection and narrowing of one end into a kind of footstalk, by which the *oöspore* attaches itself, its form passing from the globular to the pear-shaped; a partition is speedily observable in its interior, its single cell being subdivided into two; and by a continuation of a like process of duplication, first a filament and then a frondose expansion is produced, which gradually evolves itself into the likeness of the parent plant.

329. The whole of this process may be watched without difficulty, by obtaining specimens of *F. vesiculosus* at the period at which the fructification is shown to be mature by the recent discharge of the contents of

the conceptacles in some genera are masses on their orifices; for if some of the spores which are set free from the olive-green (female) receptacles be placed in a drop of sea-water in a very shallow cell, and a small quantity of the mass of antherozoids set free from the orange-yellow (male) receptacles be mingled with the fluid, they will speedily be observed, with the aid of a magnifying power of 200 or 250 diameters, to go through the same process of fertilization, and the subsequent processes of germination may be watched by means of the 'growing slide.'<sup>1</sup> The winter months, from December to March, are the most favorable for the observation of these plants, but where Fuci abound, some individuals will usually be seen in fruit at almost any period of the year.—Even in the Fucus, according to recent observations, a multiplication by transverse division of *Cerata* (§ 245), also takes place; these bodies being produced within certain of the cells that form the superficial layer of the frond, and swimming about freely for a time after their emission, until they fix themselves and begin to grow. That they

are to be considered as *gemma* (or buds), and not as generative products, appears certain from the fact that they will vegetate without the assistance of any other bodies; whereas the antherozoids of themselves never come to anything; while the octospores undergo no further changes, but decay away (as M. Thuret has experimentally ascertained) if not fecundated by the antherozoids.

330. Among the *Rhodospirææ*, or red Sea-weeds, also, we find various simple but most beautiful forms, which connect this group with the more elevated Proto-phytes, especially with the family *Charophoraceæ* (§ 256): such delicate feathery or leaf-like fronds belong for the most part to the family *Ceramium*, some members of which are found upon every part of our coasts, attached

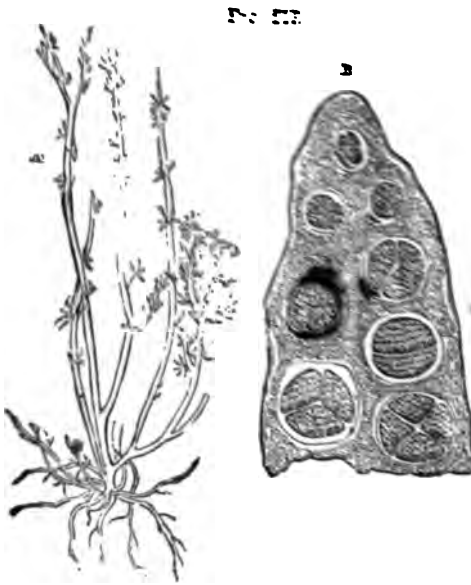

Arrangement of Tetraspores in *Carpacaulon mediterraneum*.—A, entire plant; B, longitudinal section of spore-bearing branch. (N.B. Where only three tetraspores are seen, it is merely because the fourth did not happen to be so placed as to be seen at the same view.)

either to rocks or stones or to larger Algæ, and often themselves affording an attachment to Zoophytes and Polyzoa. They chiefly live in deeper water than the other sea-weeds; and their richest tints are only exhibited when they grow under the shade of projecting rocks, or of larger dark-colored Algæ. Hence in growing them artificially in Aquaria, it is requisite to protect them from an excess of light; since otherwise they become unhealthy. Various species of the genera *Ceramium*, *Griffithsia*, *Callithamnion*, and *Ptilota*, are extremely beautiful objects for low powers, when mounted in glycerine jelly.—The only mode of propagation which

<sup>1</sup> A shallow cell should be used, so as to keep the pressure of the thin glass from the minute bodies beneath, whose movements it will otherwise impede.



was until recently known to exist in this group, is the production and liberation of 'tetraspores' (Fig. 213, B), formed by the binary subdivision of the endochromes of special cells, which sometimes form part of the general substance, of the frond, but sometimes congregate in particular parts, or are restricted to special branches. If the second binary division takes place in the same direction as the first, the spores forming the tetraspore are arranged in linear series; but if its direction is transverse to that of the first, the four spores cluster together. These, when separated by the rupture of their envelope, do not comport themselves as 'zoospores,' but, being destitute of propulsive organs, are passively dispersed by the motion of the sea itself. Their production, however, taking place by simple cell-division, and not being the result of any form of sexual conjunction, the 'tetraspores' of the *Rhodospiræ* must be regarded, like the zoospores of the *Ulvacæ*, as *gonidia*, analogous rather to the *buds* than to the *seeds* of higher Plants.—It is now known that a true Generative process takes place in this group, but the sexual organs are not usually found on the plants which produce tetraspores; so that there would appear to be an alternation between the two modes of propagation. Antheridial cells are found, sometimes on the general surface of the frond, more commonly at the ends of branches, and occasionally in special conceptacles. Their contents, however, are not motile 'antherozoids,' but minute rounded particles having no power of spontaneous movement. Sometimes on the same individuals as the antheridia, and sometimes on different ones, are organs that curiously prefigure the pistil in flowering plants; each consisting of a projecting cluster of cells, from which arises a long cell-tube termed the *trichogyne*. Fertilization is effected by the attachment of one of the antheridial particles to the trichogyne, the walls of which are absorbed at that spot, so that the fertilizing material passes down its tube to the cluster of cells at its base; and 'oospores' are thus formed either among these or in adjacent cells.—In the true *Corallines*, which are *Rhodospiræ* whose tissue is consolidated by calcareous deposit, the tetraspores are developed within a *ceramidium*, which is an urn-shaped case, furnished with a pore at its summit, and containing a tuft of pear-shaped spores arising from the base of its cavity.

331. *Hepaticæ*.—Quitting now the Algal type, and entering the series of Terrestrial Cryptogams, we have first to notice the little group of *Hepaticæ* or Liverworts, which is intermediate between Lichens and ordinary Mosses;—agreeing rather with the Algal thallus of the former in its general mode of growth, whilst approaching the latter in its fructification. This group presents numerous objects of great interest to the Microscopist; and no species is richer in these than the very common *Marchantia Polymorpha*, which may often be found growing between the paving stones of damp court-yards, but which particularly luxuriates in the neighborhood of springs or waterfalls, where its lobed fronds are found covering extensive surfaces of moist rock or soil, adhering by the radical (root) filaments which arise from their lower surface. At the period of fructification these fronds send up stalks; which carry at their

FIG. 214.



Frond of *Marchantia polymorpha*, with gemmiparous conceptacles, and lobed receptacles bearing Archegonia.

summits either round shield-like disks, or radiating bodies that bear some resemblance to a wheel without its tire (Fig. 214). The former carry the male organs, or *antheridia*; while the latter in the first instance bear the female organs, or *archegonia*, which afterwards give place to the *sporangia* or spore-cases.<sup>1</sup>

332. The green surface of the frond of *Marchantia* is seen under a low magnifying power to be divided into minute diamond-shaped spaces (Fig. 215, A, a, a) bounded by raised bands (c, c); every one of these spaces has in its centre a curious brownish-colored body (b, b), with an

FIG. 215.

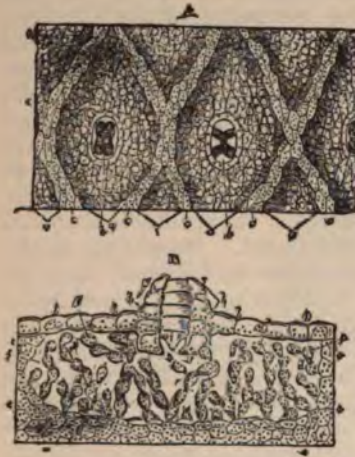

Structure of frond of *Marchantia polymorpha*:—A, portion seen from above; a, a, lozenge-shaped divisions; b, b, stomata in the centre of the lozenges; c, c, greenish bands separating the lozenges;—B, vertical section of the frond, showing a, a, the dense layer of cellular tissue forming the floor of the air-chamber, d, d; the epidermic layer, b, b, forming its roof; c, c, its walls; f, f, loose cells in its interior; g, g, stoma divided perpendicularly; h, h, rings of cells forming its wall; i, i, cells forming the obturator-ring.

FIG. 216.

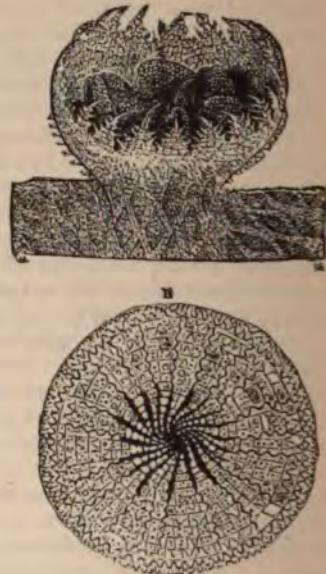

Gemmiparous Conceptacles of *Marchantia polymorpha*.—A, conceptacle fully expanded, rising from the surface of the frond, a, a, and containing gonidial disks already detached;—B, first appearance of conceptacle on the surface of the frond, showing the formation of its fringe by the splitting of the cuticle.

opening in its middle, which allows a few small green cells to be seen through it. When a thin vertical section is made of the frond (B), it is seen that each of the lozenge-shaped divisions of its surface corresponds with an air-chamber in its interior, which is bounded below by a floor (a, a) of closely-set cells, from whose under surface the radical filaments arise; at the sides by walls (c, c) of similar solid parenchyma, the projection of whose summits forms the raised bands on the surface; and above by an epidermis (b, b) formed of a single layer of cells; whilst its interior is occupied by a loosely arranged parenchyma, composed of branching

<sup>1</sup> In some species, the same shields bear both sets of organs; and in *Marchantia androgyna* we find the upper surface of one half of the pelta developing antheridia, whilst the under surface of the other half bears archegonia.

rows of cells (*f, f*) that seem to spring from the floor,—these cells being what are seen from above, when the observer looks down through the central aperture just mentioned. If the vertical section should happen to traverse one of the peculiar bodies which occupies the centres of the divisions, it will bring into view a structure of remarkable complexity. Each of these *stomata* (as they are termed, from the Greek *στομα*, mouth) forms a sort of shaft (*g*), composed of four or five rings (like the ‘courses’ of bricks in a chimney) placed one upon the other (*h*), every ring being made up of four or five cells; and the lowest of these rings (*i*) appears to regulate the aperture, by the contraction or expansion of the cells which compose it, and is hence termed the ‘obturator-ring.’ In this manner each of the air-chambers of the frond is brought into communication with the external atmosphere, the degree of that communication being regulated by the limitation of the aperture. We shall hereafter find (§ 383) that the leaves of the higher Plants contain intercellular spaces, which also communicate with the exterior by stomata; but that the structure of these organs is far less complex in them, than in this humble Liverwort.

333. The frond of *Marchantia* usually bears upon its surface, as shown in Fig. 214, a number of little open basket-shaped *gemmiparous conceptacles* (Fig. 216), which may often be found in all stages of development, and are structures of singular beauty. They contain, when mature, a number of little green round or oblong discoidal *gemmæ*, each composed of two or more layers of cells; and their wall is surmounted by a glistening fringe of ‘teeth,’ whose edges are themselves regularly fringed with minute out-growths. This fringe is at first formed by the splitting-up of the epidermis, as seen at B, at the time when the ‘conceptacle’ and its contents are first making their way above the surface. The little disks which correspond with the *gonidia* of Lichens (§ 325), are at first evolved as single globular cells, supported upon other cells which form their footstalks; these single cells, undergoing duplicative subdivision, evolve themselves into the disks; and these disks, when mature, spontaneously detach themselves from their footstalks, and lie free within the cavity of the conceptacle. Most commonly they are at last washed out by rain, and are thus carried to different parts of the neighboring soil, on which they grow very rapidly when well supplied with moisture; sometimes, however, they may be found growing whilst still contained within the conceptacles, forming natural grafts (so to speak) upon the stock from which they have been developed and detached; and many of the irregular lobes which the frond of the *Marchantia* puts forth, seem to have this origin.—The very curious observation was long ago made by Mirbel, who carefully watched the development of these *gemmæ*, that stomata are formed on the side which happens to be exposed to the light, and that root-fibres are put forth from the lower side; it being apparently a matter of indifference *which* side of the little disk is at first turned upwards, since each has the power of developing either stomata or root-fibres according to the influence it receives. After the tendency to the formation of these organs has once been given, however, by the sufficiently prolonged influence of light upon one side and of darkness and moisture on the other, any attempt to alter it is found to be vain; for if the surfaces of the young fronds be then inverted, a twisting growth soon restores them to their original aspect.

334. When the *Marchantia* vegetates in damp shady situations which are favorable to the nutritive processes, it does not readily produce the



true Fructification, which is to be looked-for rather in plants growing in more exposed places. Each of the stalked peltate (shield-like) disks contains a number of flask-shaped cavities opening upon its upper surface, which are brought into view by a vertical section; and in each of these cavities is lodged an *antheridium*, composed of a mass of 'sperm-cells,' within which are developed 'antherozoids' like those of *Chara* (Fig. 154 H), and surmounted by a long neck that projects through the mouth of the

FIG. 217

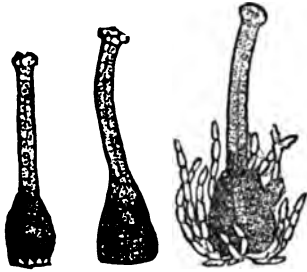

Archegonia of *Marchantia polymorpha*, in successive stages of development.

flask-shaped cavity. The wheel-like receptacles (Fig. 214), on the other hand, bear on their under surface, at an early stage, concealed between membranes that connect the origins of the lobes with one another, a set of *archegonia*, shaped like flasks with elongated necks (Fig. 217); each of these has in its interior an 'oosphere' or 'germ-cell,' to which a canal leads down from the extremity of the neck, and which is fertilized by the penetration of the antherozoids through this canal until they reach it. Instead, however, of at once evolving itself into a new plant resembling its parent, the fertilized oosphere or 'embryo-cell' develops itself into a mass of cells inclosed within a capsule, which is termed a *sporangium*; and thus the mature receptacle, in place of archegonia, bears capsules or sporangia, each of them filled with an aggregation of cells that constitute the immediate progeny of the original germ-cell. These cells, discharged by the bursting of the sporangium, are of two kinds: namely, *spores*, or gonidial-cells, inclosed in firm yellow envelopes; and *elators*, which are oval cells, each containing a double spiral fibre coiled up in its interior. This fibre is so elastic, that, when the surrounding pressure is withdrawn by the bursting of the sporangium, the spires extend themselves (Fig. 218), tearing apart the cell-membrane; and they do this so suddenly as to jerk forth the spores which may be adherent to their coils, and thus to assist in their dispersion. The spores, when subjected to moisture, with a moderate amount of light and warmth, develop themselves into little collections of cells, which gradually assume the form of flattened fronds; and thus the species is very extensively multiplied, every one of the aggregate of spores which is the product of a single germ-cell being capable of giving origin to an independent individual.

335. *Musci*.—There is not one of the tribe of *mosses* whose external organs do not serve as beautiful objects when viewed with low powers of the Microscope; while their more concealed wonders are admirably fitted for the detailed scrutiny of the practised observer. Mosses always possess a distinct axis of growth, commonly more or less erect, on which the minute and delicately-formed leaves are arranged with great regularity. The stem shows some indication of the separation of a *cortical* or bark-like portion from the *medullary* or pith-like, by the intervention of a circle of bundles of elongated cells, which seem to prefigure the woody portion of the stem of higher plants, and from which prolongations pass into the leaves so as to afford them a sort of midrib. The leaf usually consists of either a single or a double layer of cells, having flattened sides by which they adhere one to another: they rarely present any distinct epidermic layer; but such a layer, perforated by stomata of simple

structure, is commonly found on the *setæ* or bristle-like footstalks bearing the fructification and sometimes on the midribs of the leaves. The root-fibres of Mosses, like those of *Marchantia*, consist of long tubular cells of extreme transparence, within which the protoplasm may frequently be seen to circulate, as in the elongated cells of *Chara*; and according to Dr. Hicks,<sup>1</sup> it is not uncommon for portions of the protoplasmic substance to pass into an amœboid condition resembling that of the gonidia of *Volvox* (§ 242). The protoplasm first detaches itself from contact with the cell-wall, and collects itself into ovoid masses of various sizes; these gradually change their color to red or reddish-brown, subsequently, however, becoming almost colorless; and they protrude and retract processes,

FIG. 218



Elator and Spores of *Marchantia*.

FIG. 219

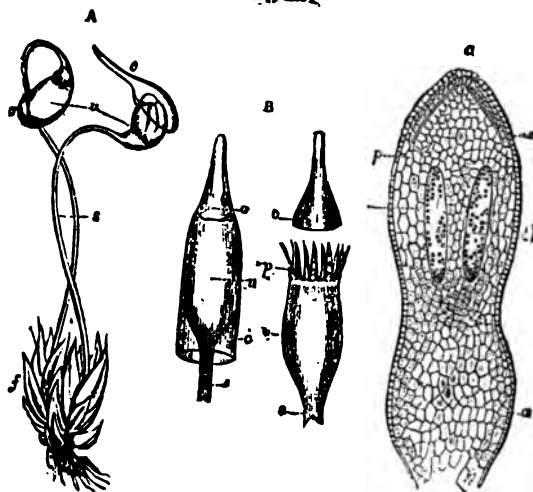

Structure of Mosses:—A, Plant of *Funaria hygrometrica*, showing *l* the leaves, *u* the urns supported upon the *setæ* or footstalks *s*, closed by the operculum *o*, and covered by the calyptra *c*:—B, Urns of *Encalypta vulgaris*, one of them closed and covered with the calyptra; the other open; *u*, *u*, the urns; *o*, *o*, the opercula; *c*, calyptra; *p*, peristome; *s*, *s*, *setæ*:—C, longitudinal section of very young urn of *Splachnum*; *a*, solid tissue forming the lower part of the capsule; *c*, columella; *l*, loculus or space around it for the development of the spores; *e*, epidermic layer of cell, thickened at the top to form the operculum *o*; *p*, two intermediate layers, from which the peristome will be formed; *s*, inner layer of cells forming the wall of the loculus.

exactly after the manner of *Amœbæ*, occasionally elongating themselves into an almost linear form, and travelling up and down in the interior of the tubular cells. This kind of movement was observed by Dr. Hicks to subside gradually, the masses of protoplasm then returning to their ovoid form; but their exterior subsequently became invested with minute cilia, by which they were kept in constant agitation within their containing cells. As to their subsequent history, we are at present entirely in the dark; and the verification and extension of Dr. Hicks's observations constitute an object well worthy of the attention of Microscopists.

<sup>1</sup> "Quart. Journ. Microsc. Science," N.S., Vol. ii. (1862), p. 96.

336. What has commonly been regarded as the 'fructification' of Mosses—namely, the 'urn' or 'capsule' filled with sporules, which is borne at the top of a long footstalk that springs from the centre of a cluster of leaves (Fig. 219, A)—is not the real fructification, but its product; for Mosses, like Liverworts, possess both *antheridia* and *archegonia*, although they are by no means conspicuous. These organs are sometimes found in the same envelope (or *perigone*), sometimes on different parts of the same plant, sometimes only on different individuals; but in

FIG. 220.

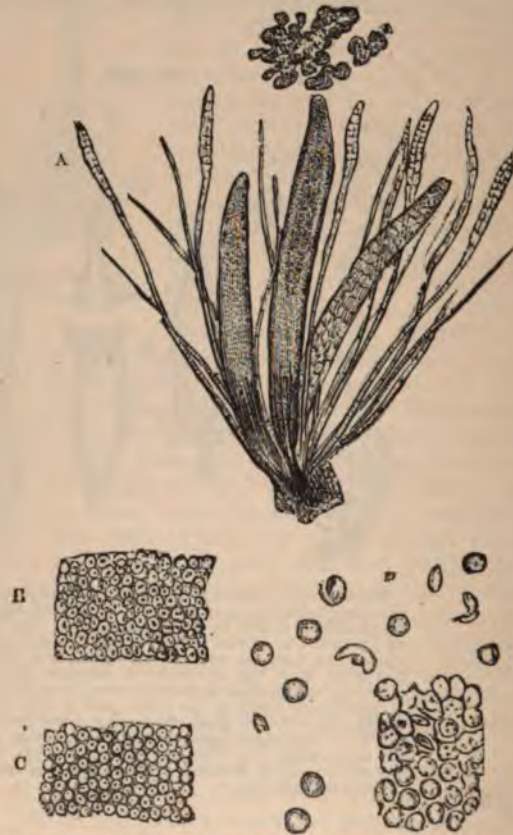

Antheridia and Antherozoids of *Polytrichum commune*:—A, group of antheridia, mingled with hairs and sterile filaments (paraphyses); of the three antheridia, the central one is in the act of discharging its contents; that on the left is not yet mature; while that on the right has already emptied itself, so that the cellular structure of its walls becomes apparent;—B, cellular contents of an antheridium, previously to the development of the antherozoids;—C, the same, showing the first appearance of the antherozoids;—D, the same, mature and discharging the antherozoids.

either case they are usually situated close to the axis, among the bases of the leaves.—The 'antheridia' are globular, oval, or elongated bodies (Fig. 220, A), composed of aggregations of cells, of which the exterior form a sort of capsule, whilst the interior are sperm-cells, each of which, as it comes to maturity, develops within itself an 'antherozoid' (B, C, D); and the antherozoids, set free by the rupture of the cells within which



they are formed, make their escape by a passage that opens for them at the summit of the antheridium. The antheridia are generally surrounded by a cluster of hair-like filaments, composed of cells joined together (Fig. 220, A), which are called *paraphyses*; these seem to be 'sterile' or undeveloped antheridia. The 'archegonia' bear a general resemblance to those of *Marchantia* (Fig. 214); and the fertilization of their contained 'oospheres' or 'germ-cells' is accomplished in the manner already described. The fertilized 'embryo-cell' becomes gradually developed by

FIG. 221.



Mouth of capsule of *Funaria*, showing the Peristome *in situ*.

FIG. 222.



Double Peristome of *Fontinalis antipyretica*.

cell-division into a conical body elevated upon a stalk; and this at length tears across the walls of a flask-shaped archegonium by a circular fissure, carrying the higher part upwards on its summit as a *calyptra* or 'hood'

FIG. 223.



Double Peristome of *Bryum intermedium*.

FIG. 224.



Double Peristome of *Cinclidium arcticum*.

(Fig. 219, B, c), while the lower part remains to form a kind of collar round the base of the stalk.

337. The Urn or 'spore-capsule,' which is thus the immediate product of the generative act, is closed at its summit by an *operculum* or lid (Fig. 219, B, o, o), which falls off when the contents of the capsule are mature, so as to give them free exit; and the mouth thus laid open is surrounded by a beautiful toothed fringe, which is turned the *peristome*. The fringe, as seen in its original undisturbed position (Fig. 221), is a beautiful ob-

ject for the Binocular Microscope: it is very 'hygometric,' executing, when breathed-on, a curious movement, which is probably concerned in the dispersion of the spores. In Figs. 222-224, are shown three different forms of peristome, spread out and detached, illustrating the varieties which it exhibits in different genera of Mosses:—varieties whose existence and readiness of recognition render them characters of extreme value to the systematic Botanist, whilst they furnish objects of great interest and beauty for the Microscopist. The peristome seems always to be originally double, one layer springing from the outer, and the other from the inner, of two layers of cells which may be always distinguished in the immature capsule (Fig. 219, c. p); but one or other of these is frequently wanting at the time of maturity, and sometimes both are obliterated, so that there is no peristome at all. The number of the 'teeth' is always a multiple of 4, varying from 4 to 64: sometimes they are prolonged into straight or twisted hairs.—The spores, or gonidial cells, are contained in the upper part of the capsule, where they are clustered round a central pillar, which is termed the *columella*. In the young capsule the whole mass is nearly solid (Fig. 219, c), the space (i) in which the spores are developed being very small: but this gradually augments, the walls becoming more condensed; and at the time of maturity the interior of the capsule is almost entirely occupied by the spores. These are formed in groups of four, by the duplicative subdivision of the 'mother-cell' which first differentiate themselves from those forming the capsule itself. Thus the 'spore-capsule in Liverworts and Mosses, being the immediate product of the act of fertilization (which constitutes the point of departure of each 'new generation'), is to be considered as the *progeny* of the plant that bears it; which, supplying the nutriment at whose expense it develops itself, acts as its 'nurse.'

335. The development of the spore into a new plant commences with the rupture of its firm, yellowish-brown outer-coat, and the protrusion of its green cell-wall proper: from the projecting extremity of which new cells are put forth by a process of out-growth, which form a sort of Coniferoid filament (as in Fig. 231, c). At certain points of this filament, its component cells multiply by subdivision, so as to form rounded clusters, from every one of which an independent plant may arise; so that several individuals may be evolved from a single spore. And as a numerous aggregate of spores is developed, as we have seen, from a single germ-cell, the rapid extension of the Mosses is thus secured, although no separate individual ever attains more than a very limited size.

339. The tribe of *Sphagnaceæ* or 'Bog-Mosses,' is now separated by Muscologists from true Mosses, on account of the marked differences by which they are distinguished: the three groups, *Hepaticæ*, *Bryaceæ* (or ordinary Mosses), and *Sphagnaceæ*, being ranked as together forming the Muscal Alliance. The stem of the *Sphagnaceæ* is more distinctly differentiated than that of the *Bryaceæ* into the central or medullary, the outer or cortical, and the intermediate or woody portions; and a very rapid passage of fluid takes place through its elongated cells, especially in the medullary and cortical layers, so that if one of the plants be placed dry in a flask of water, with its capitulum of leaves bent downwards, the water will speedily drop from this until the flask is emptied. The leaf-cells of the *Sphagnaceæ* exhibit a very curious departure from the ordinary type: for instead of being small and polygonal, they are large and elongated (Fig. 225): they contain no chlorophyll, but have spiral fibres loosely coiled in their interior: and their membranous walls have large

rounded apertures, by which their cavities freely communicate with one another, as is sometimes curiously evidenced by the passage of Wheel-Animacules that make their habitation in these chambers. Between these coarsely-spiral cells are some thick-walled narrow elongated cells, containing chlorophyll; these, which give to the leaf its firmness, do not, in the very young leaf (as Prof. Huxley first pointed out<sup>1</sup>) differ much in appearance from the others, the peculiarities of both being evolved by a gradual process of differentiation. The antheridia or male organs of *Sphagnaceæ* resemble those of Liverworts, rather than those of Mosses, in their form and arrangement; they are grouped in catkins at the tips of lateral branches, each of the imbricated perigonal leaves inclosing a single globose antheridium on a slender footstalk; and they are surrounded by very long branched paraphyses of cobweb-like tenuity. The female organs, or archegonia, which do not differ in structure from those of Mosses, are grouped together in a sheath of deep green leaves at the end

FIG. 225.



Portion of the leaf of *Sphagnum*; showing the large cells, *a, a, a*, with spiral fibres and communicating apertures; and the intervening bands, *b, b, b*, composed of small elongated cells.

FIG. 226.



Oblique section of footstalk of *Fern-leaf*, showing bundle of Scleriform Ducts.

one of the short lateral branchlets at the sides of the capitulum or summit-crown of leaves. The two sets of organs are always distributed on different branches, and in some instances on different plants. The 'capsule,' which is formed as the product of the impregnation of the germ-cell, is very uniform in all the species; being almost spherical, with a slightly convex lid, without beak or point, and showing no trace of a peristome; and the spores it contains are produced in groups of four (as in Mosses) around a hemispherical 'columella.' Besides the ordinary capsules, however, the *Sphagnaceæ* develop a smaller set of *sporogonia*, in which 'microspores' are formed by a further division of the mother-cells; the significance of these is unknown. The ordinary spores, when germinating, do not produce the branched confervoid filament of true Mosses; but if growing on wet peat, evolve themselves into a lobed foliaceous 'pro-

<sup>1</sup> See his important Article on 'The Cell-Theory' in the "British and Foreign medico-Chirurgical Review," Vol. xii. (Oct., 1853), pp. 306, 307.



thallium,' resembling the frond of Liverworts; whilst, if they develop in water, a single long filament is formed, of which the lower end gives off root-fibres, while the upper enlarges into a nodule from which the young plant is evolved. In either case, the prothallium and its temporary roots wither away as soon as the young plant begins to branch.—From their extraordinary power of imbibing and holding water, the *Sphagnaceæ* are of great importance in the economy of Nature; clothing with vegetation many areas which would otherwise be sterile, and serving as reservoirs for storing up moisture for the use of higher forms of vegetation.'

340. *Filices*.—In the general structure of *Ferns* we find a much nearer approximation to Flowering plants; but this does not extend to their Reproductive apparatus, which is formed upon a type essentially the same as that of Mosses, though evolved at a very different period of life. As the tissues of which their fabrics are composed are essentially the same as

FIG. 227.

Leaflet of *Polypodium*, with Sori.

FIG. 228.

Portion of Frond of *Hamionitis*, with Sori.

those to be described in the next chapter, it will not be requisite here to dwell upon them. The Stem (where it exists) is for the most part made up of cellular parenchyma, which is separated into a cortical and a medullary portion by the interposition of a circular series of fibro-vascular bundles containing true Woody tissue and Ducts. These bundles form a kind of irregular network, from which prolongations are given off that pass into the leaf-stalks, and thence into the midrib and its lateral branches; and it is their peculiar arrangement in the leaf-stalks, which gives to the transverse section of these the figured marking commonly known as "King Charles in the oak." A thin section, especially if somewhat oblique (Fig. 226), displays extremely well the peculiar character of the ducts of the Fern; which are termed 'scalariform,' from the

<sup>1</sup> See Dr. Braithwaite's Papers on the *Sphagnaceæ* in the "Monthly Microscopical Journal," Vol. vi., *et seq.*

resemblance of the regular markings on their walls to the rungs of a ladder.

341. What is usually considered the *fructification* of the Ferns affords a most beautiful and readily-prepared class of opaque objects for the lower powers of the Microscope; nothing more being necessary than to lay a fragment of the frond that bears it upon the glass Stage-plate, or to hold it in the Stage-forceps, and to throw an adequate light upon it by the Side-condenser. It usually presents itself in the form of isolated spots on the under surface of the frond, termed *sori*, as in the common *Polypodium* (Fig. 227), and in the *Aspidium* (Fig. 229): but sometimes these 'sori' are elongated into bands, as in the common *Scolopendrum* (hart's tongue); and these may coalesce with each other, so as almost to cover the surface of the frond with a network, as in *Hæmionitis* (Fig. 228); or they may form merely a single band along its borders, as in the common *Pteris* (brake-fern). The sori are sometimes 'naked' on the under surface of the fronds; but they are frequently covered with a delicate membrane termed the *indusium*, which may either form a sort of cap upon the summit of each sorus, as in *Aspidium* (Fig. 229), or a long fold, as in *Scolopendrum* and *Pteris*; or a sort of cup, as in *Deparia* (Fig.

FIG. 229

Sorus and Indusium of *Aspidium*.

FIG. 230.

Sorus and cup-shaped Indusium of *Deparia prolifera*.

230). Each of these sori, when sufficiently magnified, is found to be made up of a multitude of *thecæ* or spore-capsules (Figs. 229, 230), which are sometimes closely attached to the surface of the frond, but more commonly spring from it by a pedicle or footstalk. The wall of the theca is composed of flattened cells, applied to each other by their edges: but there is generally one row of these thicker and larger than the rest, which springs from the pedicle, and is continued over the summit of the capsule, so as to form a projecting ring, which is known as the *annulus* (Fig. 230). This ring has an elasticity superior to that of all the rest of the capsular wall, causing it to split across when mature, so that the contained spores may escape; and in many instances the two halves of the capsule are carried widely apart from each other, the fissures extending to such a depth as to separate them completely.—In *Osmunda* (the so-called 'flowering-fern') and *Ophioglossum* (adder's tongue), the thecæ have no annulus.—It will frequently happen that specimens of Fern-fructification gathered for the Microscope will be found to have all the capsules burst and the spores dispersed, whilst in others less advanced the capsules may all be closed; others, however, may often be met with in which some of the capsules are closed, and others are open; and if





to form a kind of confervoid filament (c); but the multiplication of cells by subdivision soon takes place transversely as well as longitudinally, so that a flattened leaf-like expansion (d) is produced, so closely resembling that of a young *Marchantia* as to be readily mistaken for it. This expansion, which is termed the *prothallium* varies in its configuration, in different species; but its essential structure always remains the same. From its under surface are developed not merely the root-fibres (a, b) which serve at the same time to fix it in the soil and to supply it with moisture, but also the *antheridia* and *archegonia* which constitute the true representatives of the essential parts of the Flower of higher

Plants. Some of the former may be distinguished at an early period of the development of the prothallium (h, h); and at the time of its complete evolution these bodies are seen in considerable numbers, especially about the origins of the root-fibres. Each has its origin in a peculiar protrusion that takes place from one of the cells of the prothallium (Fig. 232, A, a): this is at first entirely filled with chlorophyll-granules; but soon a peculiar free cell (b) is seen in its interior, filled with mucilage and colorless granules. This cell gradually becomes filled with another brood of young cells (e), and increases considerably in its dimensions, so as to fill the projection which incloses it: this part of the original cavity is now cut off from that of the cell of which it was an offshoot, and the antheridium henceforth ranks as a distinct and independent organ. Each of the sperm-cells (B, e) included within the antheridial cell, is seen, as it approaches maturity, to contain a spirally-coiled filament; and when set free by the bursting of the antheridium, the sperm-cells themselves burst, and give exit to their antherozoids (c), which execute rapid movements of rotation on their axes, partly dependent on the six long cilia with which they are furnished.

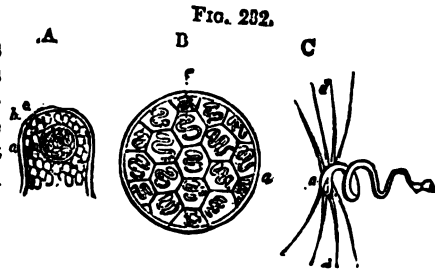

Development of the Antheridia and Antherozoids of *Pteris serrulata*.—A, projection of one of the cells of prothallium, showing the antheridial cell b, with its sperm-cells e, within the cavity of the original cell a;—B, Antheridium completely developed; a, wall of antheridial cell; e, sperm-cells, each inclosing an antherozoid;—C, Antherozoid more highly magnified, showing its large extremity a, its small extremity b, and its cilia d, d.

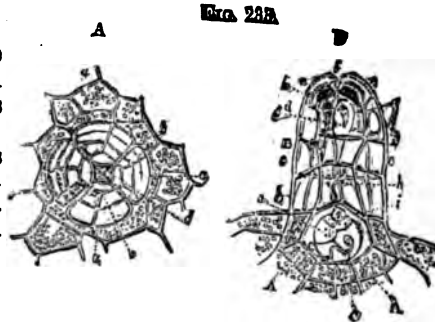

Archegonium of *Pteris serrulata*.—A, as seen from above; a, a, a, cells surrounding the base of the cavity; b, c, d, successive layers of cells, the highest inclosing a quadrangular orifice;—B, side view, showing A, A, cavity containing the germ-cell, a; b, b, walls of the archegonium, made up of the four layers of cells, b, c, d, e, and having an opening, f, on the summit; c, c, antherozoids within the cavity; g, large extremity; h, thread-like portion; i, small extremity in contact with the germ-cell, and dilated.

343. The *archegonia* are fewer in number, and are found upon a different part of the prothallium. Each of them originates in a single cell of its superficial layer, which undergoes subdivision by a horizontal partition. Of the two cells thus produced, the upper gives origin, by successive subdivisions, to the 'neck' of the archegonium, which, when fully developed (Fig. 233), is composed of twelve or more cells,

built up in layers of four cells each, one upon another, so as to form a kind of chimney or shaft, having a central passage that leads down to a cavity at its base. The lower of the two first-formed cells becomes the 'central cell' of the archegonium; and this again undergoing horizontal subdivision, the lower half becomes the oosphere or germ-cell, whilst the upper extends itself into the 'neck,' and forms a canal filled with mucilaginous protoplasm, through which the antherozoids make their way to the oosphere lying at its bottom (Fig. 233 B, a). The oosphere, when fertilized by the penetration of the antherozoids, becomes the 'embryo-cell' of a new plant, the development of which speedily commences.—In the aberrant group of *Ophioglossæ* (Adders' tongue ferns), the development of the prothallium takes place underground, in the form of a small roundish tuber, composed of parenchymatous tissue containing no chlorophyll, and producing antheridia and archegonia on its upper surface.

344. The early development of the Embryo-cell takes place according to the usual method of repeated binary subdivision, producing a homogeneous globular mass of cells. Soon, however, rudiments of special organs begin to make their appearance; the embryo grows at the expense of the nutriment prepared for it by the prothallium; and it bursts forth from the cavity of the archegonium, which organ in the mean time is becoming atrophied. In the very beginning of its development, the tendency is seen in the cells of one extremity to grow upward so as to evolve the stem and leaves, and in those of other extremity to grow downward to form the root; and when these organs have been sufficiently developed to absorb and prepare the nutriment which the young Fern requires, the prothallium decays away. Thus, then, the 'spore' of the Fern must be considered as a generative *gonidium* or detached flower-bud, capable of developing itself into a prothallium that may be likened to a receptacle bearing the sexual apparatus. But this prothallium serves the further purpose of 'nursing' the embryos originated by the generative act; which embryos finally develop themselves,—not, as in Mosses, into mere

---

'The study of the development of the spores of Ferns, and of the act of fertilization and of its products, may be conveniently prosecuted as follows:—Let a frond of a Fern whose fructification is mature be laid upon a piece of fine paper, with its spore-bearing surface downwards; in the course of a day or two this paper will be found to be covered with a very fine brownish dust, which consists of the discharged spores. This must be carefully collected, and should be spread upon the surface of a smoothed fragment of porous sandstone, the stone being placed in a saucer, the bottom of which is covered with water; and a glass tumbler being inverted over it, the requisite supply of moisture is insured, and the spores will germinate luxuriantly. Some of the prothallia soon advance beyond the rest; and at the time when the advanced ones have long ceased to produce antheridia, and bear abundance of archegonia, those which have remained behind in their growth are beginning to be covered with antheridia. If the crop be now kept with little moisture for several weeks, and then suddenly watered, a large number of antheridia and archegonia simultaneously open; and in a few hours afterwards, the surface of the larger prothallia will be found almost covered with moving antherozoids. Such prothallia as exhibit freshly-opened archegonia are now to be held by one lobe between the forefinger and thumb of the left hand, so that the upper surface of the prothallium lies upon the thumb; and the thinnest possible sections are then to be made with a thin narrow-bladed knife, perpendicularly to its surface. Of these sections, which, after much practice, may be made no more than 1-15th of a line in thickness, some will probably lay open the canals of the archegonia; and within these, when examined with a power of 200 or 300 diameters, antherozoids may be occasionally distinguished. The prothallium of the common *Osmunda regalis* will be found to afford peculiar facilities for observation of the development of the antheridia, which are produced at its margin. (See Rev. F. Howlett in "Intellectual Observer," Vol. vii., p. 33.)

spore-capsules,—but, as in Phanerogamia, into entire plants, complete in everything but the true generative organs, which evolve themselves from the detached spores.

345. The little group of *Equisetaceæ* (Horse-tails) which seem nearly allied to the Ferns in the type of their generative apparatus, though that of their vegetative portion is very different, affords certain objects of considerable interest to the Microscopist. The whole of their structure is penetrated to such an extraordinary degree by *silex*, that even when its organic portion has been destroyed by prolonged maceration in dilute nitric acid, a consistent skeleton still remains. This mineral, in fact, constitutes in some species not less than 13 per cent of the whole solid matter, and 50 per cent of the inorganic ash; and it especially abounds in the epidermis, which is used by cabinet-makers for smoothing the surface of wood. Some of the siliceous particles are distributed in two lines, parallel to the axis; others, however, are grouped into oval forms, connected with each other, like the jewels of a necklace, by a chain of particles forming a sort of curvilinear quadrangle; and these (which are, in fact, the particles occupying the cells of the stomata) are arranged in pairs. Their form and arrangement are peculiarly well seen under Polarized light, for which the prepared epidermis is an extremely beautiful object; and it is asserted by Sir D. Brewster (whose authority upon this point has been generally followed) that each siliceous particle has a regular axis of double refraction. According to Prof. Bailey, however, the effect of this

FIG. 23A.

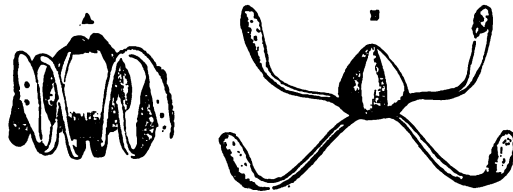
Spores of *Equisetum* with their Elastic Filaments.

and similar objects (such as the epidermis of Grasses) upon Polarized light, it is not produced by the siliceous particles, but by the organized tissues; since, when the latter have been entirely got rid of, the residual *silex* shows no doubly-refracting power.<sup>1</sup>—What is usually designated as the fructification of the *Equisetaceæ* forms a cone or spike at the extremity of certain of the stem-like branches (the real stem being a horizontal rhizoma); and consists of a cluster of shield-like disks, each of which carries a circle of *thecæ* or spore-capsules, that open by longitudinal slits to set free the spores. Each of these spores has, attached to it, two pairs of elastic filament (Fig. 23A), that are originally formed spiral fibres on the interior of the wall of the primary cell within which it is generated, and are set free by its rupture; these are at first coiled up around the spore, in the manner represented at A, though more closely applied to the surface; but, on the liberation of the spore, they extend themselves in the manner shown at B,—the slightest application of moisture, however, serving to make them close together (the assistance which they afford in the dispersion of the spores being no longer required) when the spores

<sup>1</sup> See "Silliman's American Journal of Science," May, 1856.

have alighted on a damp surface. If a number of these spores be spread out on a slip of glass under the field of view, and, whilst the observer watches them, a bystander breathes gently upon the glass, all the filaments will be instantaneously put in motion, thus presenting an extremely curious spectacle; and will almost as suddenly return to their previous condition when the effect of the moisture has passed off. If one of the *thecæ* which has opened, but has not discharged its spores, be mounted in a cell with a movable cover, this curious action may be exhibited over and over again. These spores, like those of Ferns, evolve themselves into a prothallium; and this develops antheridia and archegonia, the former at the extremities of the lobes, and the latter in the angles between them.

346. Nearly allied to Ferns, also, is a curious little group of small aquatic plants, the *Rhizocarpeæ* (or pepper-worts), which either float on the surface, or creep along shallow bottoms. These all agree in having two kinds of spores, produced in separate capsules; the larger, or 'megaspores,' giving origin to prothallia which produce archegonia only; and the smaller, or 'microspores,' undergoing progressive subdivision, usually without the formation of a distinct prothallium, each of the cells thus formed giving origin to an antherozoid. In this, as we shall presently see (§ 349), there is a distinct foreshadowing of the mode in which the generative process is performed in Flowering Plants; the 'microspore' obviously corresponding to the pollen-grain, while the 'megaspore' may be considered to represent the primitive cell of the ovule.

347. Another alliance of Ferns is to the *Lycopodiaceæ* (Club-mosses); a group which at the present time attains a great development in warm climates, and which, it would seem, constituted a large part of the arborescent vegetation of the Carboniferous epoch.—In the *Lycopodietæ* proper, the sporangia are all of one kind, and all the spores are of the same size; each, as in *Ophioglossum* (§ 343), giving origin to a subterraneous prothallium, that develops both antheridia and archegonia. The plant which originates from the fertilized 'germ-cell' of the archegonium, only attains in colder climates a Moss-like growth, with a creeping stem usually branching dichotomously, and imbricated leaves; but is distinguished from the true mosses, not only by its higher general organization (which is on a level with that of Ferns), but by the character of its fructification, which is a club-shaped 'spike,' bearing small imbricated leaves, in the axils of which lie the sporangia. The spores developed within these are remarkable for the large quantity of resinous matter they contain, giving them an inflammability that causes their being used in theatres to produce 'artificial lightning.'—But in the allied groups of *Selaginellæ* and *Isoetæ*, there are (as in the *Rhizocarpeæ*) two kinds of spores produced in separate sporangia; one set producing 'megaspores,' from which archegonia-bearing prothallia are developed; and the other producing 'microspores,' which, by repeated subdivision, give origin to antherozoids without the formation of prothallia. It is a very interesting indication of a tendency towards the Phanerogamic type of sexual generation, that the prothallium in this group is chiefly developed *within* the spore-case, forming a kind of 'endosperm' (§ 349), only the small part which projects from the ruptured apex of the spore producing one or more archegonia.—The arborescent *Lepidodendra* and *Sigillariæ* of the Coal-measures seem to have formed connecting links between the *Vascular Cryptogams* and the *Phanerogams*, alike in the structure of their Stems, and in their Fructification. For the *Lepidostrobi* or cone-like 'fruit' of these trees, represent the club-shaped spikes of the *Lycopodiaceæ*; and



seem to have borne 'megaspores' in the sporangia of its basal portion, and 'microspores' in those of its upper part. Some of the best seams of Coal appear to have been chiefly formed by the accumulation of these 'megaspores.'

348. Thus, in our ascent from the lower to the higher Cryptogams, we have seen a gradual change in the general plan of structure, bringing their superior types into a close approximation to the Flowering Plant, which is undoubtedly the highest form of vegetation. But we have everywhere encountered a mode of Generation, which, whilst essentially the same throughout the series, is no less essentially distinct from that of the Phanerogam; the fertilizing material of the 'sperm-cells' being embodied, as it were, in self-moving filaments, which find their way to 'germ-cells' by their own independent movements; and the 'embryo-cell' being destitute of that store of prepared nutriment, which surrounds it in the true Seed, and supplies the material for its early development. In the lower Cryptogamia, we have seen that the fertilized oöspore is thrown at once upon the world (so to speak) to get its own living; but in Ferns and their allies, the 'embryo-cell' is nurtured for a while by the prothallium of the parent plant. While the true *reproduction of the species* is effected by the proper Generative act, the *multiplication of the individual* is accomplished by the production and dispersion of 'gonidial' spores; and this production, as we have seen, takes place at very different periods of existence in the several groups, dividing the life of each into two separate epochs, in which it presents itself under two very distinct phases that contrast remarkably with each other. Thus, the frond of the Marchantia evolved from the spore, and bearing the antheridia and archegonia, is that which seems naturally to constitute *the Plant*; but that which represents this phase in the Ferns is the minute Marchantia-like prothallium. In Ferns, on the other hand, the product into which the fertilized 'embryo-cell' evolves itself, is that which is commonly regarded as *the Plant*: and this is represented in the Liverworts and Mosses by the spore-capsule alone.—We shall encounter a similar diversity (which has received the inappropriate designation of 'alternation of generations') in some of the lower forms of the Animal Kingdom.

<sup>1</sup> For more detailed information on the Structure and Classification of the Cryptogamia generally, the reader is referred to Prof. Sachs' "Text-book of Botany," (Bennett's translation), and to Prof. Hofmeister's large "Handbuch der Physiologischen Botanik."

*This book is the property of*  
**COOPER MEDICAL COLLEGE,**  
 SAN FRANCISCO, CAL  
*and is not to be removed from the*  
*Library Room by any person or*  
*under any pretext whatever.*

## CHAPTER IX.

## OF THE MICROSCOPIC STRUCTURE OF PHANEROGAMIC PLANTS.

349. BETWEEN the two great divisions of the Vegetable kingdom which are known as *Cryptogamia* and *Phanerogamia*, the separation is by no means so abrupt as it formerly seemed to be. For, as has been already shown, though the *Cryptogamia* were formerly regarded as altogether non-sexual, a true Generative process, requiring the concurrence of male and female elements, is traceable throughout the series. And in the higher type of that series, we have seen a foreshadowing of those provisions for the nurture of the fertilized embryo, which constitute the distinctive characters of the *Phanerogamia*. On the other hand, although we are accustomed to speak of *Phanerogamia* as 'flowering-plants,' yet not only are the conspicuous parts of the flower often wanting, but in the important group of *Gymnosperms* (including the *Coniferae* and *Cycadeae*), the essential parts of the Generative apparatus are reduced to a condition of extreme simplicity, closely approximating to that of the higher *Cryptogams*. There are, however, certain fundamental differences between the modes in which the act of fertilization is performed in the two groups. For (1) whilst in all the higher *Cryptogams*, it is in the condition of free-moving 'antherozoids' that the contents of the sperm-cell find their way to the germ-cell, these are conveyed to it, throughout the *Phanerogamic* series, by an extension of the lining membrane of the sperm-cell or pollen-grain into a tube, which penetrates to the germ-cell contained in the interior of the body called the 'ovule.' Again (2), while the 'germ-cell' or oösphere in the higher *Cryptogams* is contained in a structure that originated in a spore detached from the parent-plant, it is not only formed and fertilized in all *Phanerogams* whilst still borne on the parent fabric, but continues for some time to draw from it the nutriment it requires for its development into the 'embryo.' And at the time of its detachment from the parent, the matured 'seed' contains, not merely an 'embryo' already advanced a considerable stage, but a store of nutriment to serve for its further development during germination. As there is nothing parallel to this among *Cryptogams*, it may be said that reproduction by *seeds*, not the possession of flowers, is the distinctive character of *Phanerogams*. The *ovules*, which when fertilized and matured become seeds, are developed from specially modified leaves, which remain open in *Gymnosperms*, but which, in all other *Phanerogams*, fold together so as to inclose the ovules within an 'ovary.' Each ovule consists of a 'nucleus' surrounded by 'integuments' which remain unclosed at its anterior end, leaving open a short canal termed the 'micropyle.' One cell of the nucleus undergoes great enlargement, and becomes the *embryo-sac*, whose cavity is filled, in the first instance, with a

mucilaginous fluid containing protoplasm. At the end of of the embryo-sac nearest the micropyle, a germ-cell or 'oösphere' is developed; in Phanerogams generally by free cell-formation (§ 226), but in Gymnosperms indirectly as the product of the formation of a 'corpusculum,' which represents the archegonium of Selaginella (§ 347). By a further process of free cell-formation, the remainder of the embryo-sac comes to be filled with cells, constituting what is termed the 'endosperm;' and this serves, like the prothallium of Ferns, to imbibe and prepare nutriment which is afterwards appropriated by the embryo. In many seeds (as those of the *Leguminosæ*) the whole nutritive material of the endosperm has been absorbed into the 'cotyledons' (or seed-lobes) of the embryo, by the time that the seed is fully matured and independent of the parent; but in other cases it remains as a 'separate albumen.' In either case it is taken into the substance of the Embryo during its germination.

350. *Elementary Tissues*.—No marked change shows itself in general organization, as we pass from the Cryptogamic to the Phanerogamic Series of Plants. For a large proportion of the fabric of even the most elaborately formed Tree (including the parts most actively concerned in living action) is made up of components of the very same kind with those which constitute the entire organisms of the simplest Cryptogams. For although the Stems, Branches, and Roots of trees and shrubs are principally composed of *woody* tissue, such as we do not meet with in any but the highest Cryptogamia, yet the special office of this is to afford mechanical support: when it is once formed, it takes no further share in the vital economy, than to serve for the conveyance of fluid from the roots upwards through the stem and branches, to the leaves; and even in these organs, not only the pith and the bark, with the 'medullary rays,' which serve to connect them, but that 'cambium-layer' intervening between the bark and the wood (§ 372), in which the periodical formation of the new layers both of bark and wood takes place, are composed of *Cellular* substance. This tissue is found, in fact, wherever *growth* is taking place; as, for example, in the 'spongioles' or growing-points of the root-fibres, in the leaf-buds and leaves, and in the flower-buds and sexual parts of the flower: it is only when these organs attain an advanced stage of development, that *woody* structure is found in them,—its function (as in the stem) being merely to give support to their softer textures; and the small proportion of their substance which it forms, being at once seen in those beautiful 'skeletons,' which, by a little skill and perseverance, may be made of leaves, flowers, and certain fruits. All the softer and more pulpy tissue of these organs is composed of *cells*, more or less compactly aggregated together, and having forms that approximate more or less closely to the globular or ovoidal, which may be considered as their original type.

351. As a general rule, the rounded shape is preserved only when the cells are but loosely aggregated, as in the parenchymatous (or pulpy) substance of leaves (Fig. 235), and it is then only that the distinctness of their walls becomes evident. When the tissue becomes more solid, the sides of the vesicles are pressed against each other, so as to flatten them and to bring them into close apposition; and they then adhere to one another in such a manner, that the partitions appear, except when carefully examined, to be single instead of double as they really are. Frequently it happens that the pressure is exerted more in one direction than in another, so that the form presented by the outline of the cell varies accord-

ing to the direction in which the section is made. This is well shown in the pith of the young shoots of Elder, Lilac, or other rapidly growing trees; the cells of which, when cut transversely, generally exhibit circular outlines; whilst, when the section is made vertically, their borders are straight, so as to make them appear like cubes or elongated prisms, as in Fig. 235. A very good example of such a cellular parenchyma is to be found in the substance known as *Rice-paper*; which is made by cutting the herbaceous stem of a Chinese plant termed *Aralia papyrifera*<sup>1</sup> vertically round and round with a long sharp knife, so that its tissues may be (as it were) unrolled in a sheet.

FIG. 235.

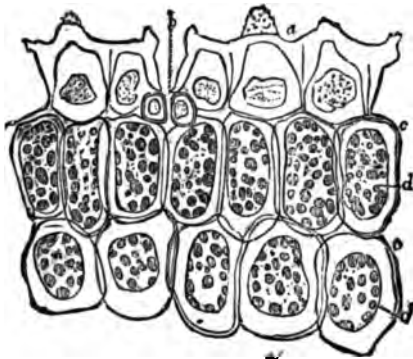

Section of Leaf of *Agave*, treated with dilute nitric acid, showing the primordial utricle contracted in the interior of the cells:—*a*, Epidermic cells; *b*, boundary-cells of the stoma; *c*, cells of parenchyma; *d*, their primordial utricles.

(Fig. 259, *a*), their growth being from the centre of the stem towards its circumference. It is obvious that fluids will be more readily transmitted in the direction of greatest elongation, being that in which they will have to pass through the least number of partitions; and whilst their ordinary course is in the direction of the *length* of the Roots, Stems, or Branches, they will be enabled by means of the medullary rays to find their way in the *transverse* direction.—One of the most curious varieties of form which Vegetable cells present, is the *stellate* cell, represented in Fig. 237, forming the spongy parenchymatous substance in the stems of many aquatic plants, of the *Rush* for example, which are furnished with air-spaces. In other instances, these air-spaces are large cavities which are altogether left void of tissue: such is the case in the *Nuphar lutea* (yellow water-lily), the footstalks of whose leaves contain large air-chambers, the walls of which are built up of very regular cubical cells, whilst some curiously-formed large stellate cells project into the cavity which they bound (Fig. 238).—The dimensions of the component vesicles of Cellular tissue are extremely variable; for although their diameter is very commonly between 1-300th and 1-500th of an inch, they occasionally measure as much as 1-30th of an inch across, whilst in other instances they are not more than 1-300th.

352. The component cells of Cellular tissue are usually held together by an intercellular substance, which may be considered analogous to the

<sup>1</sup> The *Eschynomene*, which is sometimes named as the source of this article, is an Indian plant employed for a similar purpose.



'gelatinous' layer that intervenes between the cells of the Algæ (§ 229). This, in an early stage of their development, is often very abundant, occupying more space than the cells themselves, as is seen in Fig. 239, A; and the cell-cavities are not separated from it by the interposition of a distinct membrane. As the cells enlarge and increase by duplicative sub-

FIG. 236.

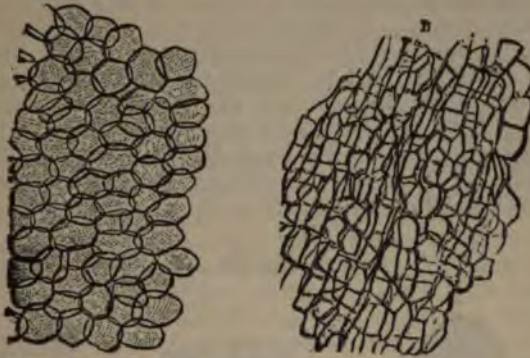

Sections of Cellular Parenchyma of *Aralia*, or Rice-paper plant:—A, transversely to the axis of the stem; B, in the direction of the axis.

division (B), the intervening substance diminishes in relative amount; and as the cells advance towards their mature condition (C), it merely shows itself as a thin layer between them. There are many forms of fully developed cellular parenchyma, in which, in consequence of the loose aggregation of their component cells, these may be readily isolated, so as

FIG. 238.



Cubical parenchyma, with stellate cells, from petiole of *Nuphar lutea*.

FIG. 237.



Section of Cellular parenchyma of *Rush*.

to be prepared for separate examination without the use of re-agents which alter their condition: this is the case with the pulp of ripe fruits, such as the Strawberry or Currant (the Snowberry is a particularly favorable subject for this kind of examination), and with the parenchyma of many fleshy leaves, such as those of the Carnation (*Dianthus caryo-*

*phyllus*) or the London Pride (*Saxifraga crassifolia*). Such cells usually contain evident *nuclei*, which are turned brownish-yellow by iodine, whilst their membrane is only turned pale-yellow; and in this way the nucleus may be brought into view, when, as often happens, it is not previously distinguishable. If a drop of the iodized solution of chloride of zinc be subsequently added, the cell-membrane becomes of a beautiful blue color, whilst the nucleus and the granular protoplasm that surrounds it retain their brownish-yellow tint. The use of dilute nitric or sulphuric acid, of alcohol, of syrup, or of several other reagents, serves to bring into view the *primordial utricle* (§ 223); its contents being made to coagulate and shrink, so that it detaches itself from the cellulose wall with which it is ordinarily in contact, and shrivels up within its cavity, as shown in Fig. 235. It would be a mistake, however, to regard this as a distinct membrane; for it is nothing else than the peripheral layer of protoplasm, naturally somewhat more dense than that which it includes, but deriving its special consistence from the operations of reagents.

FIG. 233.

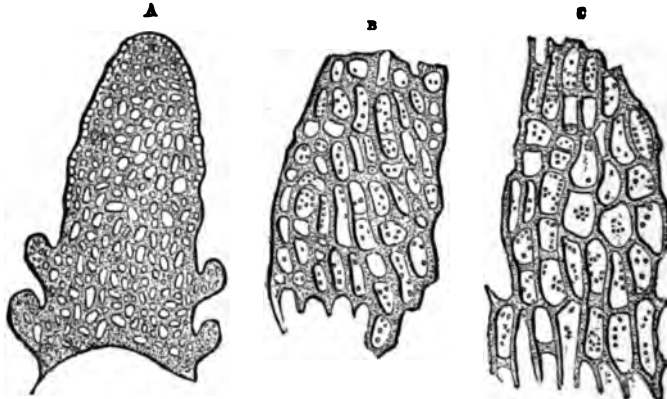

Successive stages of Cell-formation in the development of the Leaves of *Anacharis alsinastrum*.—A, growing point of the branch, consisting of a protoplasmic mass with young cells, the projections at its base being the rudiments of leaves; B, portion of one of these incipient leaves in a more advanced condition; C, the same in a still later stage of development.

353. It is probable that all Cells, at some stage or other of their growth, exhibit, in a greater or less degree of intensity, that curious movement of *cyclosis*, which has been already described as occurring in the *Characeæ* (§ 258), and which consists in the steady flow of one or of several currents of protoplasm over the inner wall of the cell; this being rendered apparent by the movement of the particles which the current carries along with it. The best examples of it are found among submerged plants, in the cells of which it continues for a much longer period than it usually does elsewhere; and among these are two, the *Vallisneria spiralis* and the *Anacharis alsinastrum*, which are peculiarly fitted for the exhibition of this interesting phenomenon.—The *Vallisneria* is an aquatic plant that grows abundantly in the rivers of the south of Europe, but is not a native of this country; it may, however, be readily grown in a tall glass jar having at the bottom a couple of inches of mould, which, after the roots have been inserted into it, should be closely pressed down, the jar being then filled with water, of which a portion should be

occasionally changed.' The jar should be freely exposed to light, and should be kept in as warm but equable a temperature as possible. The long grass-like leaves of this plant are too thick to allow the transmission of sufficient light through them for the purpose of this observation; and it is requisite to make a thin slice or shaving with a sharp knife. If this be taken from the surface, so that the section chiefly consists of the superficial layer of cells, these will be found to be small, and the particles of chlorophyll, though in great abundance, will rarely be seen in motion. This layer should therefore be sliced off (or, perhaps still better, scraped away) so as to bring into view the deeper layer, which consists of larger cells, some of them greatly elongated, with particles of chlorophyll in smaller number, but carried along in active rotation by the current of protoplasm; and it will often be noticed that the directions of the rotation in contiguous cells are opposite. If the movement (as is generally the case) be checked by the shock of the operation, it will be revived again by gentle warmth; and it may continue under favorable circumstances, in the separated fragment, for a period of weeks, or even of months. Hence, when it is desired to exhibit the phenomenon, the preferable method is to prepare the sections a little time before they are likely to be wanted, and to carry them in a small vial of water in the waistcoat pocket, so that they may receive the gentle and continuous warmth of the body. In summer, when the plant is in its most vigorous state of growth, the section may be taken from any one of the leaves; but in winter, it is preferable to select those which are a little yellow. An Objective of 1-4th inch focus will serve for the observation of this interesting phenomenon, and very little more can be seen with a 1-8th inch; but the 1-25th inch constructed by Messrs. Powell and Lealand enables the borders of the protoplasmic current, which carries along the particles of chlorophyll, to be distinctly defined; and this beautiful phenomenon may be most luxuriously watched under their patent Binocular (§ 81).

354. The *Anacharis alsinastrum* is a water-weed, which, having been accidentally introduced into this country several years ago, has since spread itself with such rapidity through our canals and rivers, as in many instances seriously to impede their navigation. It does not require to root itself in the bottom, but floats in any part of the water it inhabits; and it is so tenacious of life, that even small fragments are sufficient for the origination of new plants. The leaves have no distinct cuticle, but are for the most part composed of two layers of cells, and these are elongated and colorless in the centre, forming a kind of midrib; towards the margins of the leaves, however, there is but a single layer. Hence no preparation whatever is required for the exhibition of this interesting phenomenon; all that is necessary being to take a leaf from the stem (one of the older yellowish leaves being preferable), and to place it with a drop of water, either in the Aquatic-box, or on a slip of glass beneath a thin-glass cover. A higher magnifying power is required, however, than that which suffices for the examination of the cyclosis in *Chara* or in *Vallisneria*; the 1-8th inch Object-glass being here preferable to the 1-4th, and the assistance of the Achromatic Condenser being desirable. With

---

<sup>1</sup> Mr. Quekett found it the most convenient method of changing the water in the jars in which *Chara*, *Vallisneria*, etc., are growing, to place them occasionally under a water-tap, and allow a very gentle stream to fall into them for some hours; for by the prolonged overflow thus occasioned, all the impure water, with the *Conferva* that is apt to grow on the sides of the vessel, may be readily got rid of.

this amplification, the phenomenon may be best studied in the single layer of marginal cells; although, when a lower power is used, it is most evident in the elongated cells forming the central portion of the leaf. The number of chlorophyll-granules in each cell varies from three or four to upwards of fifty; they are somewhat irregular in shape, some being nearly circular flattened discs, whilst others are oval; and they are usually from 1-3000th to 1-5000th of an inch in diameter. When the rotation is active, the greater number of these granules travel round the margin of the cells, a few, however, remaining fixed in the centre: their rate of movement, though only 1-40th of an inch per minute, being sufficient to carry them several times round the cell within that period. As in

FIG. 240.

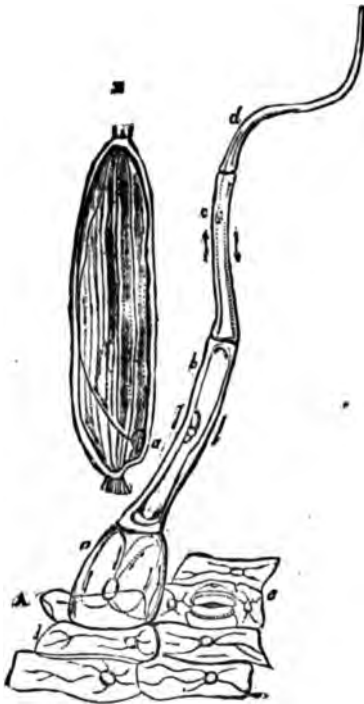

Rotation of fluid in Hairs of *Tradescantia Virginica*:—A, portion of cuticle with hair attached; a, b, c, successive cells of the hair; d, cells of the cuticles; e, Stoma:—a, joints of a beaded hair, showing several currents; a, Nucleus.

the hair itself, whereby such an injury would be done to it as to check the movement within it. The hair should then be placed with a drop of water under thin glass; and it will generally be found advantage-

case of the *Vallisneria*, the motion may frequently be observed to take place in opposite directions in contiguous cells. The thickness of the layer of protoplasm in which the granules are carried round, is estimated by Mr. Wenham at no more than 1-20,000th of an inch. When high powers and careful illumination are employed, delicate ripples may be seen in the protoplasmic currents.<sup>1</sup>

355. *Cyclosis*, however, is by no means restricted to submerged plants; for, it has been witnessed by numerous observers in so great a variety of other species, that it may fairly be presumed to be universal. It is especially observable in the hairs of the Epidermic surface; and according to Mr. Wenham,<sup>2</sup> who has given much attention to this subject, "the difficulty is to find the exceptions, for hairs taken alike from the loftiest Elm of the forest to the humblest weed that we trample beneath our feet, plainly exhibit this circulation." Such hairs are furnished by various parts of plants; and what is chiefly necessary is, that the part from which the hair is gathered should be in a state of vigorous growth. The hairs should be detached by tearing-off with a pair of fine-pointed forceps, the portion of the cuticle from which they spring; care being taken not to grasp

<sup>1</sup> 'Quart. Journ. of Microsc. Science,' Vol. iii. (1855), p. 277.

<sup>2</sup> 'On the Sap-Circulation in Plants,' in "Quart. Journ. of Microsc. Science," Vol. iv. (1856), p. 44.—It is unfortunate that Mr. Wenham should have used the term 'circulation' to designate this phenomenon, which has nothing in common with that movement of nutritive fluid through tubes or channels, to which the term is properly applicable.



ous to use a 1.8th inch Objective, with an Achromatic Condenser having a series of diaphragms. The nature of the movement in the hairs of different species is far from being uniform. In some instances, the currents pass in single lines along the entire length of the cells, as in the hairs from the filaments of the *Tradescantia virginica*, or Virginian Spiderwort (Fig. 240, A); in others there are several such currents which retain their distinctness, as in the jointed hairs of the calyx of the same plant (B); in others, again, the streams coalesce into a network, the reticulations of which change their position at short intervals, as in the hairs of *Glaucium luteum*; whilst there are cases in which the current flows in a sluggish uniformly-moving sheet or layer. Where several distinct currents exist in one cell, they are all found to have one common point of departure and return, namely, the *nucleus* (B, a); from which it seems fairly to be inferred that this body is the centre of the vital activity of the cell.—Mr. Wenham states that in all cases in which the cyclosis is seen in the hairs of a plant, the cells of the cuticle also display it, provided that their walls are not so opaque or so strongly marked as to prevent the movement from being distinguished. The cuticle may be most readily torn off from the stalk or the midrib of the leaf; and must then be examined as speedily as possible, since it loses its vitality when thus detached, much sooner than do the hairs. Even when no obvious movement of particles is to be seen, the existence of a cyclosis may be concluded from the peculiar arrangement of the molecules of the protoplasm, which are remarkable for their high refractive power, and which when arranged in a 'moving-train,' appear as bright lines across the cell; and these lines, on being carefully watched, are seen to alter their relative positions.—The leaf of the common *Plantago* (Plantain or Dock) furnishes an excellent example of cyclosis; the movement being distinguishable at the same time both in the cells and in the hairs of the cuticle torn from its stalk or midrib. It is a curious circumstance that when a plant which exhibits the cyclosis is kept in a cold dark place for one or two days, not only is the movement suspended, but the moving particles collect together in little heaps, which are broken-up again by the separate motion of their particles, when the stimulus of light and warmth occasions a renewal of the activity. It is well to collect the specimens about midday, that being the time when the rotation is most active, and the movement is usually quickened by artificial warmth, which, indeed, is a necessary condition in some instances to its being seen at all. The most convenient method of applying this warmth, while the object is on the stage of the Microscope, is to blow a stream of air upon the thin-glass cover, through a glass or metal tube previously heated in a spirit-lamp.

356. The walls of the cells of plants are frequently thickened by internal deposits, which may present very different appearances according to the manner in which they are arranged. In its simplest condition, such a deposit forms a thin uniform layer over the whole internal surface of the cellulose-wall, scarcely detracting at all from its transparence, and chiefly distinguishable by the 'dotted' appearance which the membrane then presents (Fig. 236, A). These dots, however, are not pores, as their aspect might naturally suggest, but are merely points at which the deposit is wanting, so that the original cell-wall there remains unthickened. A more complete consolidation of Cellular tissue is effected by deposits of *sclerogen* (a substance which, when separated from the resinous and other matters that are commonly associated with it, is found to be allied in chemical composition to cellulose) in successive layers, one

within another (Fig. 241, A), which present themselves as concentric rings when the cells containing them are cut through; and these layers are sometimes so thick and numerous as almost to obliterate the original cavity of the cell. By a continuance of the same arrangement as that which shows itself in the single layer of the dotted cell—each deposit being deficient at certain points and these points corresponding with

FIG. 241.

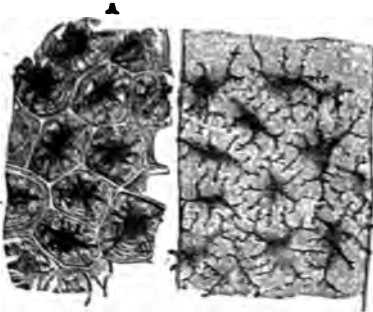

Tissue of the Testa or Seed-coat of a Star-Anise:—A, as seen in section; B, as seen on the surface.

each other in the successive layers—a series of passages is left, by which the cavity of the cell is extended at some points to its membranous wall; and it commonly happens that the points at which the deposit is wanting on the walls of the contiguous cells, are coincident, so that the membranous partition is the only obstacle to the communication between their cavities (Figs. 241-243). It is of such tissue that the 'stones' of stone-fruit, the gritty substance which surrounds the seeds and forms little hard points in the fleshy substance of the Pear, the shell of the Coconut, and the albumen of the seed of *Phytelphas* (known as 'vegetable ivory'), are made up; and we see the use of this very curious arrangement, in permitting the cells, even after they have attained a considerable degree of consolidation, still to remain permeable to the fluid required for the nutrition of the parts which such tissue incloses and protects.

FIG. 242.



Section of Cherry-stone, cutting the cells transversely.

FIG. 243.



Section of Coquilla-nut, in the direction of the long diameters of the cells.

357. The deposit sometimes assumes, however, the form of definite fibres, which lie coiled-up in the interior of cells, so as to form a single, a double, or even a triple or quadruple spire (Fig. 244). Such spiral cells are found most abundantly in the leaves of certain Orchideous

plants, immediately beneath the cuticle, where they are brought into view by vertical sections; and they may be obtained in an isolated state by macerating the leaf and peeling off the cuticle so as to expose the layer beneath, which is then easily separated into its components. In an Orchideous plant, named *Saccolabium guttatum*, the spiral cells are unusually long, and have spires winding in opposite directions; so that, by their mutual intersection, a series of diamond-shaped markings is produced. Spiral cells are often found upon the surface of the *testa* or outer coat of seeds: and in the *Collomia grandiflora*, the *Salvia verbenaca* (Wild Clary), and some other plants, the membrane of these cells if so weak, and the elasticity of their fibres so great, that, when the membrane is softened by the action of water, the fibres suddenly uncoil and elongate themselves (Fig. 245), springing out, as it were, from the surface of the seed, to which they give a peculiar flocculent appearance. This very curious phe-

FIG. 244.

Spiral cells of leaf of *Oncidium*.

FIG. 245.

Spiral fibres of Seed-coat of *Collomia*.

nomenon, which is not unfrequently spoken of by persons ignorant of its true nature as the 'germination' of the seed, may be best observed in the following manner:—A very thin transverse slice of the seed should first be cut, and laid upon the lower glass of the Aquatic box; the cover should then be pressed down, and the box placed upon the stage, so that the Microscope may be exactly focussed to the object, the power employed being the 1-inch, 2-3ds-inch, or the  $\frac{1}{2}$ -inch. The cover of the aquatic-box being then removed, a small drop of water should be placed on that part of its internal surface with which the slice of the seed had been in contact; and the cover being replaced, the object should be immediately looked at. It is important that the slice of the seed should be very thin, for two reasons: first, that the view of the spires may not be confused by their aggregation in too great numbers; and second, that the drop of water should be held in its place by capillary attraction, instead of running down and leaving the object, as it will do if the glasses be too widely separated.

358. In some part or other of most Plants, we meet with cells containing granules of *starch*, which especially abounds in the tubers of the Potato, and in the seeds of Cercals and Legumes. Starch grains are originally formed in the interior of Chlorophyll-corpuscles; but as they in-

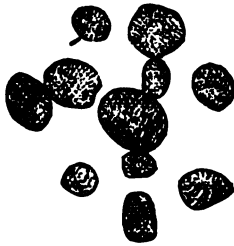
crease in size, the chlorophyll thins itself out as a mere covering film, and at last disappears altogether. So long as the starch-grains remain imbedded in the protoplasm-layer, they continue to grow; but when they accumulate so as to occupy the cell-cavity, their growth stops. They are sometimes minute and very numerous, and so closely packed as to fill the cell-cavity (Fig. 246); in other instances they are of much larger dimensions, so that only a small number of them can be included in any one cell; while in other cases, again, they are both few and minute, so that they form but a small proportion of the cell-contents. Their nature is at once detected by the addition of a solution of Iodine, which gives them a beautiful blue color. Each granule, when highly magnified, exhibits a peculiar spot, termed the *hilum*; round which are seen a set of circular lines, that are for the most part concentric (or nearly so) with it. When viewed by Polarized light, each grain exhibits a dark cross, the point of intersection being at the hilum (Fig. 247); and when a Selenite-plate is interposed, the cross becomes beautifully colored. Opinions have been very much divided regarding the internal structure of the starch-grain; but the doctrine of Nageli,<sup>1</sup> that it is composed of successive layers which

FIG. 246.

Cells of *Paeony*, filled with starch.

FIG. 247.



Granules of Starch, as seen under Polarized light.

increase by 'intussusception,' is the one now generally adopted. These layers differ in their proportion of water; the outermost layer, which is the most solid, having within it a watery layer; this, again, being succeeded by a firm layer, which is followed by a watery layer; and so on,—the proportion of water increasing towards the centre in both kinds of layers, and attaining its maximum in the innermost part of the grain where the formation of new layers takes place, causing the distention of the older ones.—Although the dimensions of the Starch-grains produced by any one species of plant are by no means constant, yet there is a certain average for each, from which none of them depart very widely; and by reference to this average, the starch-grains of different plants that yield this product in abundance may be microscopically distinguished from one another, a circumstance of considerable importance in commerce. The largest starch-grains in common use are those of the plant (a species of *Canna*) known as *Tous les mois*; the average diameter of those of the *Potato* is about the same as the diameter of the smallest of the *Tous les mois*; and the size of the ordinary starch-grains of *Wheat* and of *Sago* is about the same as that of the smallest grains of *Potato*-starch; while the granules of *Rice*-starch are so very minute as to be at once distinguishable from any of the preceding.

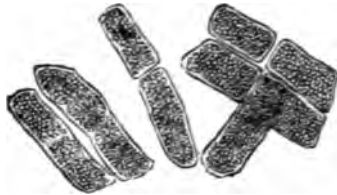
<sup>1</sup> See his papers in "Sitzungsberichte der Kön. Bayer. Akad. der Wissenschaften," 1862 and 1863; and Sachs' "Handbook of Botany" (Bennett's Translation), pp. 56-62.



359. Deposits of Mineral matter in a crystalline condition, known as *raphides*, are not unfrequently found in vegetable cells; where they are at once brought into view by the use of Polarized light. Their designation (derived from  $\rho\alpha\phi\iota\varsigma$ , a needle) is very appropriate to one of the most common states in which these bodies present themselves, that, namely, of bundles of needle-like crystals, lying side-by-side in the cavity of the cell; such bundles are well seen in the cells lying immediately beneath the cuticle of the bulb of the medicinal Squill. It does not apply, however, to other forms which are scarcely less abundant; thus, instead of bundles of minute needles, single large crystals, octohedral or prismatic, are frequently met with; and the prismatic crystals are often aggregated in beautiful stellate groups. One of the most common materials of raphides is Oxalate of Lime, which is generally found in the stellate form; and no plant yields these stellate raphides so abundantly as the common *Rhubarb*, the best specimens of the dry medicinal root containing as much as 35 per cent of them. In the cuticle of the bulb of the *Onion* the same material occurs under the octohedral or the prismatic form. In other instances, the Calcareous base is combined with Tartaric, Citric, or Malic acid; and the acicular raphides are said to consist usually of Phosphate of Lime. Some Raphides are as long as 1-40th of an inch, while others measure no more than 1-100th. They occur in all parts of plants, —the Wood, Pith, Bark, Root, Leaves, Stipules, Sepals, Petals, Fruits, and even in the Pollen. They are always situated in cells, and not, as some have stated, in intercellular passages; the cell-membrane, however, is often so much thinned away as to be scarcely distinguishable. Certain plants of the *Cactus* tribe, when aged, have their tissues so loaded with raphides as to become quite brittle; so that when some large specimens of *C. senilis*, said to be a thousand years old, were sent to Kew Gardens from South America, some years since, it was found necessary for their preservation during transport to pack them in cotton, like jewelry. Raphides are probably to be considered as non-essential results of the Vegetative processes; being for the most part produced by the union of organic acids generated in the plant, with mineral bases imbibed by it from the soil. The late Mr. E. Quekett succeeded in artificially producing raphides within the cells of Rice-paper (§ 351), by first filling these with Lime-water by means of the air-pump, and then placing the paper in weak solutions of Phosphoric and Oxalic acids. The artificial raphides of Phosphate of Lime were rhombohedral; while those of Oxalate of Lime were stellate, exactly resembling the natural raphides of the *Rhubarb*.<sup>1</sup>

360. A large proportion of the denser parts of the fabric of the higher Plants is made up of the substance which is known as *ligneous tissue* or *woody fibre*. This, however, can only be regarded as a very simple variety of cellular tissue; for it is composed of peculiarly elongated cells (Fig. 259), usually pointed at their two extremities so as to become

<sup>1</sup>The materials of the above paragraph are derived from the excellent section on this subject in Prof. Quekett's "Lectures on Histology." Besides the Vegetable structures therein named as affording good illustrations of different kinds of Raphides, may be mentioned the parenchyma of the leaf of *Agave*, *Aloe*, *Cycas*, *Encephalartos*, etc.; the cuticle of the bulb of the *Hyacinth*, *Tulip*, and *Garlic* (and probably of other bulbs); the bark of the *Apple*, *Cascarilla*, *Cinchona*, *Lime*, *Locust*, and many other trees; the pith of *Eleagnus*, and the testa of the seeds of *Anagallis* and the *Elm*.—The Raphides characteristic of the different Natural Orders of Plants were carefully studied by Mr. Gulliver; who gave an account of them in successive Papers in "Ann. Nat. Hist.," 1861 *et seq.*

spindle-shaped, whose walls have a special tendency to undergo consolidation by the internal deposit of sclerogen. It is obvious that a tissue consisting of elongated cells, adherent together by their entire length, and strengthened by internal deposit, must possess much greater tenacity than any tissue in which the cells depart but little from the primitive spherical form; and we accordingly find Woody fibre present wherever it is requisite that the fabric should possess not merely density, but the power of resistance to tension. In the higher classes of the Vegetable Kingdom it constitutes the chief part of the stem and branches, where these have a firm and durable character; and even in more temporary structures, such as the herbaceous stems of annual Plants, and the leaves and flowers of almost every tribe, this tissue forms a more or less important constituent, being especially found in the neighborhood of the spiral vessels and ducts, to which it affords protection and support. Hence the bundles of fasciculi composed of these elements, which form the 'veins' of leaves, and which give 'stringiness' to various esculent vegetable substances, are commonly known under the name of *fibro-vascular* tissue. In their young and unconsolidated state, the ligneous cells seem to conduct fluids with great facility in the direction of their length; and in the *Coniferous* tribe, whose stems and branches are destitute of ducts, they afford the sole channel for the ascent of the sap. But after their walls have become thickened by internal deposit, they are no longer subservient to this function: nor, indeed, do they then appear to fulfil any other purpose in the Vegetable economy than that of affording mechanical support. It is this which constitutes the difference between the *alburnum* or 'sap-wood,' and the *duramen* or 'heartwood,' of Exogenous stems (§ 369).

361. A peculiar set of markings seen on the Woody fibres of the *Conifera*, and of some other tribes, is represented in Fig. 248; in each of these spots the inner circle appears to mark a deficiency of the lining deposit, as in the pitted cells of other plants: whilst the *outer* circle indicates the boundary of a lenticular cavity which intervenes between the adjacent cells at this point. There are varieties in this arrangement so characteristic of different tribes, that it is sometimes possible to determine, by the microscopic inspection of a minute fragment, even of a Fossil wood, the tribe to which it belonged. The woody fibre thus marked is often designated as *glandular*.

362. All the more perfect forms of Phanerogamia contain, in some part of their fabric, the peculiar structures which are known as *spiral vessels*.<sup>1</sup> These have the elongated shape of woody fibres; but the internal deposit, as in the spiral cells (§ 357), takes the form of a spiral fibre winding from end to end, remaining distinct from the cell-wall, and retaining its elasticity; this fibre may be single, double, or even quadruple,—this last character presenting itself in the very large elongated fibre-cells of the *Nepenthes* (Chinese Pitcher-plant). Such cells are especially found in the delicate membrane (medullary sheath) surrounding the pith of Exogens, and in the midst of the woody bundles occurring in the stem of Endogens; thence they proceed in each case to the leaf-stalks, through which they are distributed to the leaves. By careful dissection under the Microscope, they may be separated entire;

<sup>1</sup>So long, however, as they retain their original cellular character, and do not coalesce with each other, these fusiform spiral cells cannot be regarded as having any more claim to the designation of *vessels*, than have the elongated cells of the ligneous tissue.

but their structure may be more easily displayed by cutting *round*, but not *through*, the leaf-stalk of the Strawberry, Geranium, etc., and then drawing the parts asunder. The membrane composing the tubes of the vessels will thus be broken across; but the fibres within, being elastic, will be drawn out and unrolled. Spiral vessels are sometimes found to convey *liquid*, whilst in other cases they contain *air* only; the conditions of this difference are not yet certainly known.

363. Although fluid generally finds its way with tolerable facility through the various forms of cellular tissue, especially in the direction of the greatest length of their cells, a more direct means of connection between distant parts is required for its active transmission. This is afforded by *ducts*, which consist merely of cells laid end to end, the partitions between them being more or less obliterated. The origin of these Ducts in cells is occasionally very evident, both in the contraction of

FIG. 249.

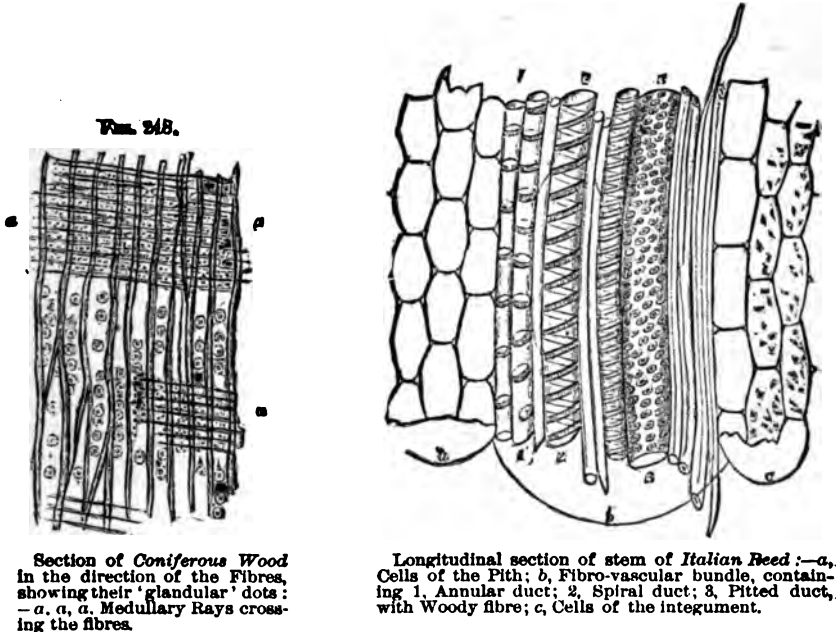

their calibre at regular intervals, and in the persistence of remains of their partitions (Fig. 263, *b, b*); but in most cases it can only be ascertained by studying the history of their development, neither of these indications being traceable. The component cells appear to have been sometimes simply membranous, but more commonly to have been of the fibrous type (§ 357). Some of the ducts formed from the latter (Fig. 249, 2) are so like continuous spiral vessels as to be scarcely distinguishable from them, save in the want of elasticity in their spiral fibre, which causes it to break when the attempt is made to draw it out. This rupture would seem to have taken place, in some instances, from the natural elongation of the cells by growth; the fibre being broken up into rings, which lie sometimes close together, but more commonly at considerable intervals; such a duct is said to be *annular* (Fig. 249, 1). Intermediate

forms between the spiral and annular ducts, which show the derivation of the latter from the former, are very frequently to be met with. The spires are sometimes broken up still more completely, and the fragments of the fibre extend in various directions, so as to meet and form an irregular network lining the duct, which is then said to be *reticulated*. The continuance of the deposit, however, gradually contracts the meshes, leaving the walls of the duct marked only by pores like those of porous cells (§ 356); and such canals, designated as *pitted* ducts, are especially met with in parts of most solid structure and least rapid growth (Fig. 249, 3). The 'scalariform' ducts of Ferns (§ 340) are for the most part of the spiral type; but spiral ducts are frequently to be met with also in the rapidly growing leaf-stalks of Flowering-plants, such as the Rhubarb. Not unfrequently, however, we find all forms of ducts in the same bundle, as seen in Fig. 249. The size of these ducts is occasionally so great as to enable their openings to be distinguished by the unaided eye; they are usually largest in stems whose size is small in proportion to the surface of leaves which they support, such as the common Cane, or the Vine; and, generally speaking, they are larger in woods of dense texture, such as Oak or Mahogany, than in those of which the fibres, remaining unconsolidated, can serve for the conveyance of fluid. They are entirely absent in the *Coniferae*.

364. The Vegetable tissues whose principal forms have been now described, but among which an immense variety of detail is found, may be either studied as they present themselves in thin *sections* of the various parts of the plant under examination, or in the isolated conditions in which they are obtained by *dissection*.—The former process is the most easy, and yields a large amount of information; but still it cannot be considered that the characters of any tissue have been properly determined until it has been dissected out. Sections of some of the hardest Vegetable substances, such as 'vegetable ivory,' the 'stones' of fruit, the 'shell' of the Cocoa-nut, etc. (§ 356), can scarcely be obtained except by slicing and grinding (§ 192); and these may be mounted either in Canada balsam or in Glycerine jelly. In cases, however, in which the tissues are of only moderate firmness, the section may be most readily and effectually made with the 'Microtome' (§ 184); and there are few parts of the Vegetable fabric which may not be advantageously examined by this means, any very soft or thin portions being placed in it between two pieces of cork, elder-pith, or carrot. In certain cases, however, in which even this compression would be injurious, the sections must be made with a sharp knife, the substance being laid on the nail or a slip of glass.—In dissecting the Vegetable Tissues, scarcely any other instrument will be found really necessary, than a pair of needles (in handles), one of them ground to a cutting edge. The adhesion between the component cells, fibres, etc., is often sufficiently weakened by a few hours' maceration to allow of their readily coming apart, when they are torn asunder by the needle points beneath the simple lens of a Dissecting-microscope. But if this should not prove to be the case, it is desirable to employ some other method for the sake of facilitating their isolation. None is so effectual as the boiling of a thin slice of the substance under examination, either in dilute nitric acid, or in a mixture of nitric acid and chlorate of potass. This last method (which was devised by Schultz) is the most rapid and effectual, requiring only a few minutes for its performance; but as oxygen is liberated with such freedom as to give an almost explosive character to the mixture, it should be put in practice with extreme



caution. After being thus treated, the tissue should be boiled in alcohol, and then in water; and it will then be found very easy to tear apart the individual cells, ducts, etc., of which it may be composed. These may be preserved by mounting in weak spirit.

365. *Stem and Root.*—It is in the stems and roots that we find the greatest variety of tissues in combination, and the most regular plans of structure; and sections of these viewed under a low magnifying power are objects of peculiar beauty, independently of the scientific information which they afford. The Axis (under which term is included the stem with its branches, and the roots with its ramifications) always has for the basis of its structure a dense cellular parenchyma; though this, in the advanced stage of development, may constitute but a small portion of it. In the midst of the parenchyma we generally find 'fibro-vascular' bundles, consisting of woody fibre, with ducts of various kinds, and (very commonly) spiral vessels. It is in the mode of arrangement of these bundles, that the fundamental difference exists between the stems

FIG. 250.



Transverse Section of Stem of young Palm.

FIG. 251.

Portion of Transverse Section of Stem of  
Waghie Cane.

which are commonly designated as *endogenous* (growing from within), and those which are more correctly termed *exogenous* (growing on the outside): for in the former the bundles are dispersed throughout the whole diameter of the axis without any peculiar plan, the intervals between them being filled up by cellular parenchyma; whilst in the latter they are arranged side by side in such a manner as to form a hollow cylinder of *wood*, which includes within it the portion of the cellular substance known as *pith*, whilst it is itself inclosed in an envelope of the same substance that forms the *bark*. These two plans of Axis-formation respectively characteristic of those two great groups into which Phanerogams are subdivided—namely, the *Monocotyledons* and the *Dicotyledons*—will now be more particularly described.

366. When a transverse section (Fig. 250) of a *monocotyledonous* Stem is examined microscopically, it is found to exhibit a number of fibro-vascular bundles, disposed without any regularity in the midst of the mass of cellular tissue, which forms (as it were) the matrix or basis of the fabric. Each bundle contains two, three, or more large ducts, which

are at once distinguished by the size of their openings; and these are surrounded by woody fibre and spiral vessels, the transverse diameter of which is so extremely small, that the portion of the bundles which they form is at once distinguished in transverse section by the *closeness* of its texture (Fig. 251). The bundles are least numerous in the centre of the stem, and become gradually more approximated towards its circumference but it frequently happens that the portion of the area in which they are most compactly arranged is not absolutely at its exterior, this portion being itself surrounded by an investment composed of cellular tissue only; and sometimes we find the central portion, also, completely destitute of fibro-vascular bundles: so that a sort of indication of the distinction between Pith, Wood, and Bark is here presented. This distinction, however, is very imperfect: for we do not find either the central or the peripheral portions ever separable, like pith and bark, from the intermediate woody layer. In its young state, the centre of the stem is always filled-up with cells; but these not unfrequently disappear after a time, except at the *nodes*, leaving the stem hollow, as we see in the whole tribe of Grasses.

FIG. 252.

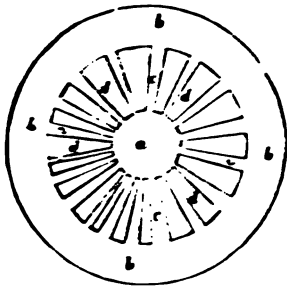
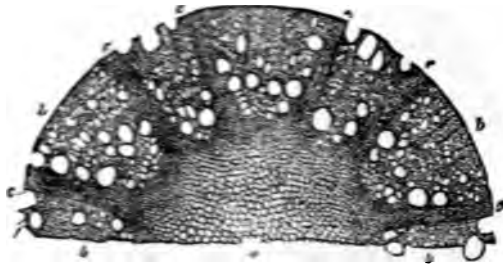

Diagram of the first formation of an Exogenous Stem: —a, Pith; b b, Bark; c c, plates of cellular tissue (Medullary Rays, left between the Woody Bundles d d

FIG. 253.



Transverse Section of Stem of Clematis:—a, pith; b, b, b, woody bundles; c, c, c, medullary rays.

When a vertical section is made of a woody stem (as that of a Palm) of sufficient length to trace the whole extent of the fibro-vascular bundles, it is found that whilst they pass at their upper extremity into the leaves, they pass at the lower end toward the surface of the stem, and assist, by their interlacement with the outer bundles, in forming that extremely tough investment which the lower ends of these stems present. New fibro-vascular bundles are being continually formed in the upper part of the stem, in continuity with the leaves which are successively put forth at its summit; but while these take part in the elongation of the stem, they contribute but little to the increase of its diameter. For those which are most recently formed only pass into the centre of the stem during the higher part of their course, and usually make their way again to its exterior at no great distance below; and when once formed, they receive no further additions. It was from the idea formerly entertained that these successively-formed bundles descend in the interior of the stem through its entire length until they reach the roots, and that the stem is thus continually receiving additions to its interior, that the term *endogenous* was given to this type of stem-structure; but from the fact just stated regarding the course of the fibro-vascular bundles, it is obvious that such a doctrine cannot be any longer admitted.



367. In the Stems of *dicotyledonous* Phanerogams, on the other hand, we find a method of arrangement of the several parts, which must be regarded as the highest form of the development of the axis, being that in which the greatest *differentiation* exists. A distinct division is always seen in a transverse section (Fig. 252) between three concentric areas,—the *pith*, the *wood*, and the *bark*; the first (*a*) being central, the last (*b*) peripheral, and these having the wood interposed between them, its circle being made up of wedged-shaped bundles (*d, d*), kept apart by the bands (*c, c*), that pass between the pith and the bark.—The *pith* (Fig. 253, *a*) is almost invariably composed of cellular tissue only, which usually, presents (in transverse section) a hexagonal areolation. When newly formed it has a greenish hue, and its cells are filled with fluid, but it gradually dries-up and loses its color; and not unfrequently its component cells are torn apart by the rapid growth of their envelope, so that irregular cavities are found in it; or, if the stem should increase with extreme rapidity, it becomes hollow, the pith being reduced to fragments, which are found adhering to its interior wall. The pith is immediately surrounded by a

FIG. 251.



Transverse Section of Stem of *Rhamnus* (Buckthorn), showing concentric layers of wood.

FIG. 253.



Portion of the same, more highly magnified.

delicate membrane consisting almost entirely of spiral vessels, which is termed the *medullary sheath*.

368. The *woody* portion of the stem (Fig. 253, *b, b*), is made up of woody fibres, usually with the addition of ducts of various kinds; these, however, are absent in one large group, the *Coniferæ* or Fir tribe with its allies (Figs. 258–260) in which the woody fibres are of unusually large diameter, and have the peculiar markings already described (§ 361). In any stem or branch of more than one year's growth, the woody structure presents a more or less distinct appearance of division into concentric rings, the number of which varies with the age of the tree (Fig. 254). The composition of the several rings, which are the sections of so many cylindrical layers, is uniformly the same, however different their thickness; but the arrangement of the two principal elements—namely, the woody fibre and the ducts—varies different species: the ducts being sometimes almost uniformly diffused through the whole layer, but in other instances being confined to its inner part; while in other cases, again, they are dispersed with a certain regular irregularity (if such an expression may be allowed), so as to give a curiously figured





albumnum, an additional layer of the innermost part of the albumnum is every year consolidated by internal deposit, and is thus added to the exterior of the duramen. More generally, however, this consolidation is gradually effected, and the albumnum and duramen are not separated by any abrupt line of division.

370. The *medullary rays* which cross the successive rings of wood connecting the cellular substance of the pith with that of the bark, and dividing each ring of wood into wedge-shaped segments, are thin plates of cellular tissue (Fig. 253, *c, c*), not usually extending to any great depth in the vertical direction. It is not often, however, that their character

FIG. 257.

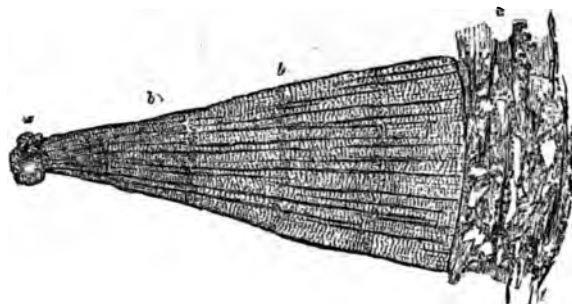

Portion of Transverse Section of the Stem of Cedar:—*a*, pith; *b, b, b*, woody layers; *c*, bark.

can be so clearly seen in a transverse section as in the diagram just referred to; for they are usually compressed so closely as to appear darker than the wedges of woody tissue between which they intervene (Figs. 255, 257); and their real nature is best understood by a comparison of *longitudinal* sections made in two different directions,—namely *radial* and *tangential*,—with the transverse.

Three such sections of a fossil Coniferous wood in the Author's possession are shown in Figs. 258–260. The stem was of such large size, that, in so small a part of the area of its transverse section as is represented in Fig. 258, the medullary rays seem to run parallel to each other, instead of radiating from a common centre. They are very narrow; but are so closely set together, that only two or three rows of woody fibres (no ducts being here present) intervene between any pair of them. In the longitudinal section taken in a radial direction (Fig. 259), and consequently passing in the same course with the medullary rays, these are seen as thin plates (*a, a, a*) made-up of superposed cells very much elongated, and crossing in a horizontal direction the woody fibres which lie parallel to one another vertically. And in the tangential section (Fig. 260), which passes a direction at right angles to

FIG. 258.

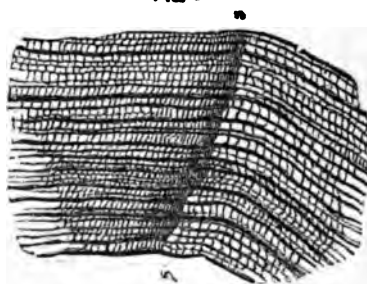

Portion of Transverse Section of large Stem of Coniferous Wood (fossil), showing part of two annual layers, divided at *a, a*, and traversed by very thin but numerous Medullary Rays.

that of the medullary rays, and therefore cuts them across, we see that each of the plates thus formed has a very limited depth from above downwards, and is composed of no more than one thickness of horizontal

FIG. 259



Portion of Vertical Section of the same wood, taken in a radial direction, showing the glandular Woody fibres, without Ducts, crossed by the Medullary Rays, a, a.

FIG. 260.



Portion of Vertical Section of the same wood, taken in a tangential direction, so as to cut across the Medullary Rays.

cells.—A section of the stem of *Mahogany* taken in the same direction as the last (Fig. 261), gives a very good view of the cut ends of the medullary rays, as they pass between the woody fibres; and they are seen to be here

FIG. 261.



FIG. 262.



FIG. 263.

FIG. 261.—Vertical Section of *Mahogany*.

FIG. 262.—Transverse section of a Fossil Wood; showing the Medullary Rays, a, a, a, a, a, running nearly parallel to each other, and the openings of large Ducts in the midst of the woody fibres.

FIG. 263.—Vertical (tangential) section of the same wood; showing the Woody fibres separated by the Medullary Rays, and by the large Ducts, b b, b b.

of somewhat greater thickness, being composed of two or three rows of cells, arranged side by side.

371. In another fossil wood, whose transverse section is shown in Fig. 262, and its tangential section in Fig. 263, the medullary rays are seen to occupy a much larger part of the substance of the stem: being shown in the transverse section as broad bands (*a a, a a*) intervening between the closely-set woody fibres, among which some large ducts are scattered; whilst in the tangential, they are observed to be not only deeper than the preceding from above downwards, but also to have a much greater thickness. This section also gives an excellent view of the ducts, *b b, b b*, which are here plainly seen to be formed by the coalescence of large cylindrical cells, lying end-to-end.—In another fossil wood in the Author's possession, the medullary Rays constitute a still larger proportion of the stem; for in the transverse section (Fig. 261), they are seen as very broad bands (*b, b*), alternating with plates of woody structure (*a, a*), whose thickness is often less than their own; whilst in the tangential section (Fig. 265) the cut extremities of the medullary rays occupy a very large part of the area, having apparently determined the sinuous course of the

FIG. 264.



FIG. 265.



Transverse and Vertical Sections of a Fossil Wood; showing the separation of the Woody plates, *a a, a a*, by the very large Medullary Rays, *b b, b b*.

woody fibres; instead of looking (as in Fig. 260) as if they had forced their way between the woody fibres, which there hold a nearly straight and parallel course on either side of them.—The medullary rays maintain a connection between the external and the internal parts of the cellular basis of the stem, which have been separated by the interposition of the wood.

372. The *bark* may be usually found to consist of three principal layers; the external, or *epiphylæum*, also termed the *suberosus* (or corky) layer; the middle, or *mesophylæum*, also termed the *cellular envelope*; and the internal, or *endophylæum*, which is more commonly known as the *liber*. The two outer layers are entirely cellular; and are chiefly distinguished by the form, size, and direction of their cells. The *epiphylæum* is generally composed of one or more layers of colorless or brownish cells, which usually present a cubical or tabular form, and are arranged with their long diameters in the horizontal direction; it is this which, when developed to an unusual thickness, forms *cork*, a substance which is by no means the product of one kind of tree exclusively, but exists in greater or less abundance in the bark of every exogenous stem. The *mesophylæum* consists of cells, usually of green color, prismatic in their form, and dis-



posed with their long diameters parallel to the axis; it is more loosely arranged than the preceding, and contains intercellular passages, which often form a network of canals that have been termed laticiferous vessels; and, although usually less developed than the suberous layers, it sometimes constitutes the chief thickness of the bark. The *liber* or 'inner bark,' on the other hand, usually contains woody fibre in addition to the cellular tissue and laticiferous canals of the preceding; and thus approaches more nearly in its character to the woody layers, with which it is in close proximity on its inner surface. The 'liber' may generally be found to be made up of a succession of thin layers, equalling in number those of the wood, the innermost being the last formed; but no such succession can be distinctly traced either in the cellular envelope or in the suberous layer, although it is certain that they too augment in thickness by additions to their interior, whilst their external portions are frequently thrown-off in the form of thickish plates, or detach themselves in smaller and thinner laminae.—The bark is always separated from the wood by the *cambium-layer*, which is the part wherein all new growth takes place; this seems to consist of mucilaginous semi-fluid matter; but it is really made-up of cells of a very delicate texture, which gradually undergo transformation, whereby they are for the most part converted into woody fibres, ducts, spiral vessels, etc. These materials are so arranged as to augment the fibro-vascular bundles of the wood on their external surface, thus forming a new layer of 'alburnum,' which *incloses* all those that preceded it; whilst they also form a new layer of 'liber,' on the *interior* of all those which preceded it: they also extend the medullary rays, which still maintain a continuous connection between the pith and the bark; and a portion remains unconverted, so as always to keep apart the liber and the alburnum.—This type of stem-structure is termed *exogenous*; a designation which applies very correctly to the mode of increase of the woody layers, although (as just shown) the liber is formed upon a truly endogenous plan.

373. Numerous departures from the normal type are found in particular tribes of Dicotyledons. Thus in some the wood is not marked by concentric circles, their growth not being interrupted by any seasonal change. In other cases, again, each woody zone is separated from the next by the interposition of a thick layer of cellular substance. Sometimes wood is formed in the bark (as in *Calycanthus*), so that several woody columns are produced, which are quite independent of the principal woody axis, but cluster around it. Occasionally the woody stem is divided into distinct segments by the peculiar thickness of certain of the medullary rays; and in the stem of which Fig. 266 represents a transverse section, these cellular plates form four large segments, disposed in the manner of a Maltese cross, and alternating with the four woody segments, which they equal in size.

374. The Exogenous stem, like the (so-called) Endogenous, consists, in its first-developed state, of cellular tissue only; but after the leaves have been actively performing their functions for a short time, we find a circle of fibro-vascular bundles, as represented in Fig. 252, interposed between the central (or medullary) and the peripheral (or cortical) portions of the cellular matrix; these fibro-vascular bundles being themselves separated from each other by plates of cellular tissue, which still remain to connect the central and the peripheral portions of that matrix. This first stage in the formation of the Exogenous axis, in which its principal parts—the pith, wood, bark, and medullary rays—are marked-out, is seen



even in the stems of herbaceous Plants, which are destined to die down at the end of the season (Fig. 267); and sections of these, which are very easily prepared, are most interesting Microscopic objects. In such stems, the difference between the Endogenous and the Exogenous type is manifested in little else than the disposition of the fibro-vascular layers; which are scattered through nearly the whole of the cellular matrix (although more abundant towards its exterior) in the former case; but are limited to a circle within the peripheral portion of the cellular tissue in the latter. It is in the further development which takes place during succeeding years in the woody stems of perennial Exogens, that those characters are displayed, which separate them most completely from the Ferns and their allies, whose stems contain a cylindrical layer of fibro-vascular bundles, as well as from (so-called) Endogens. For whilst the

FIG. 266



Transverse section of the stem of a climbing plant (*Aristolochia?*) from New Zealand.

FIG. 267.



Portion of transverse section of *Arctium* (Burdock), showing one of the Fibro-vascular bundles that lies beneath the cellular integument.

fibro-vascular layers of the latter, when once formed, undergo no further increase, those of Exogenous stems are progressively augmented on their outer side by the metamorphosis of the cambium-layer; so that each of the bundles which once lay as a mere series of parallel cords beneath the cellular investment of a first-year's stem, may become in time the small end of a wedge-shaped mass of wood, extending continuously from the centre to the exterior of a trunk of several feet in diameter, and becoming progressively thicker as it passes upwards. The fibro-vascular bundles of Exogens are therefore spoken of as 'indefinite;' whilst those of Endogens and Acrogens (Ferns, etc.) are said to be 'definite' or 'closed.'

375. The structure of the roots of Endogens and Exogens is essentially the same in plan with that of their respective Stems. Generally speaking, however, the roots of Exogens have no pith, although they have medullary rays; and the succession of distinct rings is less apparent in them, than it is in the stems from which they diverge. In the delicate radical filaments which proceed from the larger root-fibres, a central bundle of vessels will be seen, enveloped in a sheath of cellular substance; and this investment also covers in the end of the fibril, which is usually somewhat dilated, and composed of peculiarly succulent tissue, forming what is termed the *spongiole*. The structure of the radical filaments may be well

studied in the common *Duckweed*, every floating leaf of which has a single fibril hanging down from its lower surface.

376. The structure of Stems and Roots cannot be thoroughly examined in any other way, than by making sections in different directions with the Microtome. The general instructions already given (§ 184) leave little to be added respecting this special class of objects; the chief points to be attended to being the preparation of the Stems, etc., for slicing, the sharpness of the knife and the dexterity with which it is handled, and the method of mounting the sections when made. The wood, if green, should first be soaked in strong alcohol for a few days, to get rid of the resinous matter; and it should then be macerated in water for some days longer, for the removal of its gum, before being submitted to the cutting-process. If the wood be dry, it should first be softened by soaking for a sufficient length of time in water, and then treated with spirit, and afterwards with water, like green wood. Some woods are so little affected even by prolonged maceration, that boiling in water is necessary to bring them to the degree of softness requisite for making sections. No wood that has once been dry, however, yields such good sections as that which is cut fresh. When a piece, of the appropriate length, has been placed in the grasp of the Section-instrument (wedges of deal or other soft wood being forced-in with it, if necessary for its firm fixation), a few thick slices should first be taken to reduce its surface to an exact level; the surface should then be wetted with spirit, the Micrometer-screw moved through a small part of a revolution, and the slice taken off with the razor, the motion given to which should partake both of *drawing* and *pushing*. A little practice will soon enable the operator to discover, in each case, *how thin* he may venture to cut his sections without a breach of continuity; and the Micrometer-screw should be turned so as to give the required elevation. If the surface of the wood has been sufficiently wetted, the section will not curl-up in cutting, but will adhere to the surface of the razor, from which it is best detached by dipping the razor in water so as to float away the slice of wood, a camel-hair pencil being used to push it off, if necessary. All the sections that may be found sufficiently thin and perfect, should be put aside in a bottle of weak spirit until they be mounted. For the minute examination of their structure, they may be mounted either in weak spirit or in glycerine jelly. Where a mere general view only is needed, dry-mounting answers the purpose sufficiently well; and there are many stems, such as the *Clematis*, of which transverse sections rather thicker than ordinary make very beautiful *opaque* objects, when mounted dry on a black ground. Canada Balsam should not be had recourse to, except in the case of very opaque section, as it usually makes the structure too transparent. Transverse section, however, when slightly charred by heating between two plates of glass until they turn brown, may be mounted with advantage in Canada balsam and are then very showy specimens for the Gas-Microscope. The number of beautiful and interesting objects which may be thus obtained from even the commonest Trees, Shrubs, and herbaceous Plants, at the cost of a very small amount of trouble, can scarcely be conceived save by those who have specially attended to these wonderful structures. And a careful study of sections made in different parts of the stem, especially in the neighborhood of the 'growing point,' will reveal to the eye of the Physiologist some of the most important phenomena of Vegetation. The judicious use of the *staining process* (§§ 200-203) not only improves the appearance of such sections, but adds greatly to their scientific value.—*Fossil Woods*, when well preserved, are generally *silicified*, and can only be



cut and polished by a lapidary's wheel. Should the Microscopist be fortunate enough to meet with a portion of a *calcified* stem in which the organic structure is preserved, he should proceed with it after the manner of other hard substances which need to be reduced by grinding (§§ 182-194).

377. *Epidermis and Leaves*.—On all the softer parts of the higher plants, save such as grow under water, we find a surface layer, differing in its texture from the parenchyma beneath, and constituting a distinct membrane, known as the *Epidermis*.<sup>1</sup> This membrane is composed of

FIG. 268.



Epiderm of Leaf of *Yucca*.

FIG. 269.

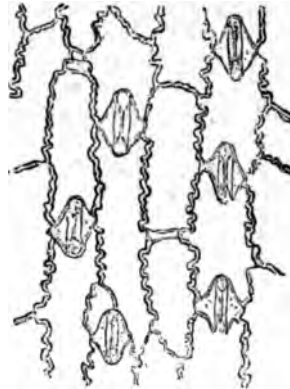

Epiderm of Leaf of *Indian Corn (Zea Mays)*.

cells; the walls of which are flattened above and below, whilst they adhere closely to each other laterally, so as to form a continuous stratum (Figs. 272, 274, *a, a*). Their shape is different in almost every tribe of plants; thus in the epiderm of the *Yucca* (Fig. 268), *Indian Corn* (Fig. 269), *Iris* (Fig. 273), and most other Monocotyledons, the cells are elongated,

FIG. 270.

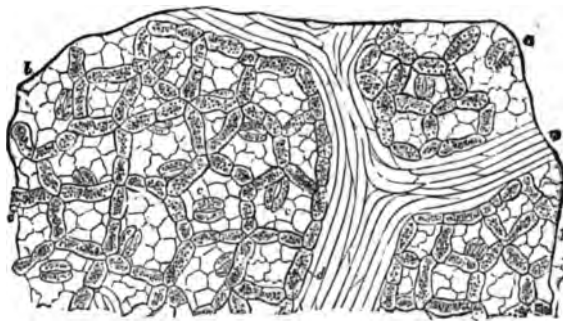

Portion of Epiderm of inferior surface of Leaf of *Apple*, with layer of Parenchyma in immediate contact with it:—*a, a*, elongated cells overlying the veins of the leaf; *b, b*, ordinary epiderm cells, overlying the parenchyma; *c, c*, stomata; *d, d*, green cells of the parenchyma, forming a very open network near the lower surface of the leaf.

<sup>1</sup> This term, borrowed from Animal structure, is singularly inappropriate in Botany, since it properly designates a layer lying upon the *derm* or true skin: and the Writer would have therefore preferred to retain the old term 'Cuticle,' were it not that this is now applied by the highest authorities to the thin pellicle covering the Epiderm (§ 881).

and present an approach to a rectangular contour; their margins being straight in the *Yucca* and *Iris*, but minutely sinuous or crenated in the *Indian Corn*. In most Dicotyledons, on the other hand, the cells of the epiderm depart less from the form of circular disks; but their margins usually exhibit large irregular sinuosities, so that they seem to fit together like the pieces of a dissected map, as is seen in the epiderm of the *Apple* (Fig. 270, *b, b*). Even here, however, the cells of that portion of the epiderm (*a, a*) which overlies the 'veins' of the leaf, have an elongated form, approaching that of the wood-cells of which these veins are chiefly composed; and it seems likely, therefore, that the elongation of the ordinary epiderm-cell of Monocotyledons has reference to that parallel arrangement of the veins which their leaves almost constantly exhibit.

378. The cells of the epiderm are colorless, or nearly so, having no chlorophyll in their interior; and their walls are generally thickened by secondary deposit, especially on the side nearest the atmosphere. This deposit is of a waxy nature, and consequently renders the membrane very impermeable to fluids, so as to protect the soft tissue of the leaf from drying up. In most European plants the epiderm contains but a single row of cells, which, moreover, are usually thin-sided; whilst in the generality of tropical species, there exist two, three, or even four layers of thick-sided cells; this last number being seen in the *Oleander*, the epiderm of which,

FIG. 271.



Portion of Epiderm of upper surface of Leaf of *Rochea falcata*, as seen at A from its inner side, and at B from its outer side:—*a, a*, small cells forming inner layer; *b, b*, large prominent cells of outer layer; *c, c*, stomata disposed between the latter.

when separated, has an almost leathery firmness. This difference in conformation is obviously adapted to the conditions of growth under which these plants respectively exist; since the epiderm of a plant indigenous to temperate climates, would not afford a sufficient protection to the interior structure against the rays of a tropical sun; whilst the less powerful heat of this country would scarcely overcome the resistance presented by the dense and non-conducting tegument of a species formed to exist in tropical climates.

379. A very curious modification of the epiderm is presented by the *Rochea falcata*, which has the surface of its ordinary epiderm (Figs. 271, 272, *a, a*, nearly covered with a layer of large prominent isolated cells, *b, b*. A somewhat similar structure is found in the *Mesembryanthemum crystallinum*, commonly known as the Ice-plant; a designation it owes to the peculiar appearance of its surface, which looks as if it were covered with frozen dewdrops. In other instances, the epiderm is partially invested by a layer of *scales*, which are nothing else than flattened cells, often having a very peculiar form; whilst in numerous cases, again, we find the surface beset with *hairs*, which occasionally consist of single



elongated cells, but are more commonly made up of a linear series, attached end to end, as in Fig. 240. Sometimes these hairs bear little glandular bodies at their extremities, by the secretion of which a peculiar viscosity is given to the surface of the leaf, as in the Sundew (*Drosera*); in other instances, the hair has a glandular body at its base, with whose secretion it is moistened, so that when this secretion is of an irritating quality, as in the *Nettle*, it constitutes a 'sting.' A great variety of such organs may be found, by a microscopic examination of the surface of the leaves of plants having any kind of superficial investment to the epiderm. Many connecting links present themselves between hairs and scales, such as the stellate hairs of the *Deutzia scabra*, which a good deal resemble these within the air-chambers of the Yellow Waterlily (Fig. 238).

380. The Epidermis in many plants, especially those belonging to the *Grass* tribe, has its cell-walls impregnated with *silex*, like that of the *Equisetum* (§ 345); so that when the organic matter seems to have been got rid-of by heat or by acids, the forms of the cuticle-cells, hairs, stomata, etc., are still marked-out in *silex*, and (unless the dissipation of the organic matter has been most perfectly accomplished) are most beautifully displayed by Polarized light. Such silicified epiderms are found in the husks of the grains yielded by these plants: and there is none in which a larger proportion of mineral matter exists, than that of *Rice*, which contains some curious elongated cells with toothed margins. The hairs with which the *paleæ* (chaff-scales) of most Grasses are furnished, are strengthened by the like siliceous deposit; and in the *Festuca pratensis*, one of the common meadow-grasses, the *paleæ* are also beset with longitudinal rows of little cup-like bodies formed of silica. The epiderm and scaly hairs of *Deutzia scabra* also contain a large quantity of *silex*; and are remarkably beautiful objects for the Polariscopes.

381. Externally to the epidermis there usually exists a very delicate transparent 'cuticle,' showing no decided traces of organization, though occasionally somewhat granular in appearance, and marked by lines that seem to be impressions of the junctions of the cells with which it was in contact. When detached by maceration, it not only comes off from the surface of the epiderm, but also from that of the hairs, etc., which this may bear. This membrane is obviously formed by the agency of the epidermic cells; and it seems to consist of the external layers of their thickened cellulose walls, which have coalesced with each other, and have separated themselves from the subjacent layers.

382. In nearly all plants which possess a distinct epidermis, this is perforated by the minute openings termed *stomata* (Figs. 270-272, *c, c*); which are bordered by cells of a peculiar form, distinct from those of the epidermis, and more resembling in character those of the tissue beneath. These boundary-cells are usually somewhat kidney-shaped, and lie in pairs (Fig. 273, *b, b*), with an oval opening between them; but by an alteration in their form, the opening may be contracted or nearly closed.

FIG. 272.



Portion of Vertical Section of leaf of *Rochea*, showing the small cells, *a, a*, of the inner layer of Epidermis; the large cells, *b, b*, of the outer layer; *c, c*, one of the stomata; *d, d*, cells of the parenchyma; *L*, cavity between the parenchymatous cells, into which the stoma opens.

In the epiderm of *Yucca*, however, the opening is bounded by two pairs of cells, and is somewhat quadrangular (Fig. 268); and a like doubling of the boundary-cells, with a narrow slit between them, is seen in the epiderm of the *Indian corn* (Fig. 269). In the stomata of no Phanerogam, however, do we meet with any conformation at all to be compared in complexity with that which has been described in the humble *Marsippos* (§ 352).—Stomata are usually found most abundantly (and sometimes exclusively) in the epiderm of the *lower* surfaces of leaves, where they open into the air-chambers that are left in the parenchyma which lies next the inferior epiderm; in leaves which float on the surface of water, however, they are found in the epiderm of the upper surface only; whilst in leaves that habitually live entirely submerged, as there is

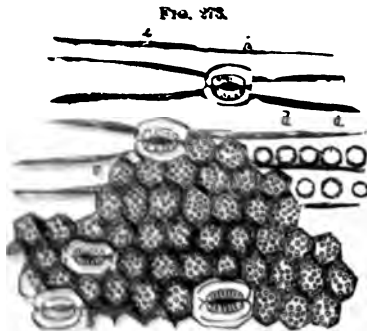

Portion of Epidermis of Leaf of *Iris germanica*, torn from its surface, and carrying away with it a portion of the parenchymatous layer in immediate contact with it:—a, a, elongated cells of the cuticle; b, b, cells of the stomata; c, c, cells of the parenchyma; d, d, impressions on the epidermic cells formed by their contact; e, e, cavities in the parenchyma, corresponding to the stomata.

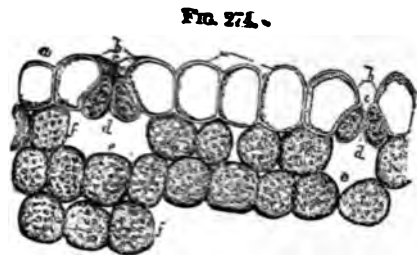

Vertical section of Epidermis and of portion of subjacent parenchyma of leaf of *Iris germanica* taken in a transverse direction:—a, a, cells of epiderm; b, b, cells at the sides of the stomata; c, c, small green cells placed within these; d, d, openings of the stomata; e, e, cavities in the parenchyma into which the stomata open; f, f, cells of the parenchyma.

no distinct epiderm, so there are no stomata. In the erect leaves of Grasses, the Iris tribe, etc., they are found equally (or nearly so) on both surfaces. As a general fact, they are least numerous in *succulent* plants, whose moisture, obtained in a scanty supply, is destined to be retained in the system; whilst they abound most in those which exhale fluid most readily, and therefore absorb it most quickly. It has been estimated that no fewer than 160,000 are contained in every square inch of the under surface of the leaves of *Hydrangea* and of several other plants; the greatest number seeming always to be present where the upper surface of the leaves is entirely destitute of these organs. In *Iris germanica*, each surface has nearly 12,000 stomata in every square inch, and in *Yucca*, each surface has 40,000.—In *Oleander*, *Banksia*, and some other plants, the stomata do not open directly upon the lower surface of the epiderm, but lie in the deepest part of little pits or depressions, which are excavated in it and lined with hairs; the mouths of these pits, with the hairs that line them, are well brought into view by taking a thin slice from the surface of the epiderm with a sharp knife; but the form of the cavities and the position of the stomata can only be well made-out in vertical sections of the leaves.

383. The internal structure of leaves is best brought into view by making vertical sections, that shall traverse the two layers of epiderm

and the intermediate cellular parenchyma; portions of such sections are shown in Figs. 272, 274, and 275. In close apposition with the cells of the upper epiderm (Fig. 274, *a. a.*), which may or may not be perforated with stomata (*c, c, d, d.*) we find a layer of soft thin-walled cells, containing a large quantity of chlorophyll; these generally press so closely one against another, that their sides become mutually flattened, and no spaces are left, save where there is a definite air-chamber into which the stoma opens (Fig. 274, *e.*); and the compactness of this superficial layer is well seen, when, as often happens, it adheres so closely to the epiderm, as to be carried away with this when it is torn off (Fig. 273, *c, c.*). Beneath this first layer of leaf-cells, there are usually several others rather less compactly arranged; and the tissue gradually becomes more and more lax, its cell not being in close apposition, and large intercellular passages being left amongst them, until we reach the lower epiderm, which the parenchyma only touches at certain points, its lowest layer forming a set of network (Fig. 270, *d, d.*) with large interspaces, into which the stomata open. It is to this arrangement that the darker shade of green almost invariably presented by the superior surfaces of leaves is princi-

FIG. 275.



Portion of vertical longitudinal section of leaf of *Iris*, extending from one of its flattened sides to the other:—*a, a.* elongated cells of Epiderm; *b, b.* stomata cut through longitudinally; *c, c.* green cells of parenchyma; *d, d.* colorless tissue, occupying interior of leaf.

pally due; the color of the component cells of the parenchyma not being deeper in one part of the leaf than in another.—In those plants, however, whose leaves are erect instead of being horizontal, so that their two surfaces are equally exposed to light, the parenchyma is arranged on both sides in the same manner, and their epiderms are furnished with an equal number of stomata. This is the case, for example, with the leaves of the common garden *Iris* (Fig. 275); in which, moreover, we find a central portion (*d, d.*) formed by thick-walled colorless tissue, very different either from ordinary leaf-cells or from woody fibre. The explanation of its presence is to be found in the peculiar conformation of the leaves; for if we pull one of them from its origin, we shall find that what appears to be the flat expanded blade really exposes but half its surface; the blade being doubled together longitudinally, so that what may be considered its under surface is entirely concealed. The two halves are adherent together at their upper part, but at their lower they are commonly separated by a new leaf which comes-up between them; and it is from this arrangement, which resembles the position of the legs of a man on horseback, that the leaves of the *Iris* tribe are said to be *equitant*. Now by tracing the middle layer of colorless cells, *d, d.* down to that lower portion of the leaf where its two halves diverge from one another, we find that it there becomes continuous with the epiderm, to the cells of which (Fig.



275, *a*) these bear a strong resemblance in every respect save the greater proportion of their breadth to their length.—Another interesting variety in leaf-structure is presented by the *Water-Lily* and other Plants whose leaves float on the surface; for here the usual arrangement is entirely reversed, the closely-set layers of green leaf-cells being found in contact with the lower surface, whilst all the upper part of the leaf is occupied by a loose spongy parenchyma, containing a very large number of air-spaces that give buoyancy to the leaf; and these spaces communicate with the external air through the numerous stomata, which, contrary to the general rule (§ 382), are here found in the upper epiderm alone.<sup>1</sup>

384. The examination of the foregoing structures is attended with very little difficulty. Many epiderms may be torn off, by the exercise of a little dexterity, from the surfaces of the leaves they invest, without any preparation; this is especially the case with Monocotyledons generally, the veins of whose leaves run parallel, and with such Dicotyledons as have very little woody structure in their leaves; in those, on the other hand, whose leaves are furnished with reticulated veins to which the epiderm adheres (as is the case in by far the larger proportion), this can only be detached by first macerating the leaf for a few days in water; and if their texture should be particularly firm, the addition of a few drops of nitric acid to the water will render their cuticles more easily separable. Epiderms may be advantageously mounted either in weak spirit, or in glycerine-jelly.—Very good sections of most leaves may be made by a sharp knife, handled by a careful manipulator; but it is generally preferable to use the Microtome, placing the leaf between two pieces either of very soft cork or of elder-pith or carrot, or imbedding it in paraffine (§ 189). In order to study the structure of leaves with the fulness that is needed for scientific research, numerous sections should be made in different directions; and slices taken parallel to the surfaces, at different distances from them, should also be examined. There is no known medium in which such sections can be preserved altogether without change; but some one of the methods formerly described (§ 206) will generally be found to answer sufficiently well.

385. *Flowers*.—Many small flowers, when looked-at entire with a low magnifying power, are very striking Microscopic objects; and the interest of the young in such observations can scarcely be better excited, than by directing their attention to the new view they thus acquire of the 'composite' nature of the humble down-trodden *Daisy*, or to the beauty of the minute blossoms of many of those *Umbelliferous* Plants which are commonly regarded only as rank weeds. The Scientific Microscopist, however, looks more to the organization of the separate parts of the flower; and among these he finds abundant sources of gratification, not merely to his love of knowledge, but also to his taste for the beautiful. The general structure of the *sepals* and *petals*, which constitute the 'perianth' or floral envelope, closely corresponds with that of leaves; the chief difference lying in the peculiar change of hue which the chlorophyll almost invariably undergoes in the latter class of organs, and very frequently in the former also. There are some petals, however, whose cells exhibit very interesting peculiarities, either of form or marking, in addition to their distinctive coloration;<sup>2</sup> such are those of the *Geranium* (Pelargo-

<sup>1</sup> See the classical Memoir by Ad. Brongniart on the Structure of Leaves, in "Ann. des Sci. Nat.," Tom. xxi. (1830) pp. 420-458.

<sup>2</sup> See especially Mr. Tuffen West 'On some Conditions of the Cell-Wall in the Petals of Flowers,' in "Quart. Journ. of Microsc. Science," Vol. vii. (1859), p. 22.



nium), of which a small portion is represented in Fig. 276. The different portions of this petal—when it has been dried after stripping it of its epiderm, immersed for an hour or two in oil of turpentine, and then mounted in Canada balsam—exhibit a most beautiful variety of vivid coloration, which is seen to exist chiefly in the thickened partitions of the cells; whilst the surface of each cell presents a very curious opaque spot with numerous diverging prolongations. This method of preparation, however, does not give a true idea of the structure of the cells; for each of them has a peculiar mammillary protuberance, the base of which is surrounded by hairs; and this it is which gives the velvety appearance to the surface of the petal, and which, when altered by drying and compression, occasions the peculiar spots represented in Fig. 276. Their real character may be brought into view by Dr. Inman's method; which consists in drying the petal (when stripped of its epiderm) on a slip of glass, to which it adheres, and then placing on it a little Canada balsam diluted with Turpentine, which is to be boiled for an instant over the spirit-lamp, after which it is to be covered with a thin glass. The boiling 'blisters' it, but does not remove the color; and on examination many



FIG. 276  
Cells from Petal of Geranium  
(*Pelargonium*.)

of the cells will be found showing the mammilla very distinctly, with a score of hairs surrounding its base, each of these slightly curved, and pointing towards the apex of the mammilla.—The petal of the common Scarlet Pimpernel (*Anagallis arvensis*), that of the common Chick-weed (*Stellaria media*), together with many others of a small and delicate character, are also very beautiful microscopic objects; and the two just named are peculiarly favorable subjects for the examination of the spiral vessels in their natural position. For the 'veins' which traverse these petals are entirely made-up of spiral vessels, none of which individually attain any great length; but one follows or takes the place of another, the conical commencement of each somewhat overlapping the like termination of its predecessor; and where the 'veins' seem to branch, this does not happen by the bifurcation of a spiral vessel, but by the 'splicing-on' (so to speak) of one to the side of another, or of two new vessels diverging from one another to the end of that which formed the principal vein.

386. The *anthers* and *pollen-grains*, also, present numerous objects of great interest, both to the scientific Botanist and to the amateur Microscopist. In the first place, they afford a good opportunity of studying that form of 'free' cell-development which seems peculiar to the parts concerned in the reproductive process, and which consists in the development of a new cell-wall round an isolated mass of protoplasm forming part of the contents of a 'parent-cell;' so that the new cell lies free within its cavity, instead of being formed by its subdivision, as in the ordinary method of multiplication (§ 226).—If the anther be examined by thin sections at an early stage of its development within the young flower-bud, it will be found to be made-up of ordinary cellular parenchyma in which no peculiarity anywhere shows itself: but a gradual 'differentiation' speedily takes place, consisting in the development of a set of a very



large cells in two vertical rows, which occupy the place of the *loculi* or 'pollen-chambers' that afterwards present themselves; and these cells give origin to the pollen-grains, whilst the ordinary parenchyma remains to form the walls of the pollen-chambers. The pollen-grains are formed within 'mother-cells,' the endoplasm of each breaking up into four segments. These become invested by a double envelope, a firm *extine*, and a thin *intine*; and they are set free, when mature, by the bursting of the pollen-chambers. It is not a little curious that the layer of cells which lines the pollen-chambers should exhibit, in a considerable proportion of plants, a strong resemblance in structure, though not in form, to the elaters of *Marchantia* (Fig. 218). For they have in their interior a fibrous deposit; which sometimes forms a continuous spiral (like that in Fig. 244), as in *Narcissus* and *Hyoscyamus*; but it is often broken-up, as it were, into rings, as in the *Iris* and *Hyacinth*; in many instances forms an irregular network, as in the *Violet* and *Saxifrage*; in other cases, again, forms a set of interrupted arches, the fibres being deficient on one side, as in the *Yellow Water-lily*, *Bryony*, *Primrose*, etc.; whilst a very peculiar stellate aspect is often given to these cells, by the convergence of the interrupted fibres towards one point of the cell-wall, as in the *Cactus*, *Geranium*, *Madder*, and many other well-known plants. Various intermediate modifications exist; and the particular form presented often varies in different parts of the wall of one and the same anther. It seems probable that, as in *Hepaticæ*, the elasticity of these spiral cells may have some share in the opening of the pollen-chambers and in the dispersion of the pollen-grains.

387. The form of the pollen-grains seems to depend in part upon the mode of division of the cavity of the parent-cell into quarters; generally speaking it approaches the spheroidal, but it is sometimes elliptical, and sometimes tetrahedral. It varies more, however, when the pollen is dry, than when it is moist; for the effect of the imbibition of fluid, which usually takes place when the pollen is placed in contact with it, is to soften-down angularities, and to bring the cell nearer to the typical sphere. The extine or outer coat of the pollen-grain often exhibits very curious markings, which seem due to an increased thickening at some points, and a thinning-away at others. Sometimes these markings give to the surface-layer so close a resemblance to a stratum of cells (Fig. 277, B, C, D), that only a very careful examination can detect the difference. The roughening of the surface by spines or knobby protuberances, as shown at A, is a very common feature; and this seems to enable the pollen-grains more readily to hold to the surface whereon they may be cast. Besides these and other inequalities of the surface, most pollen-grains have what appear to be pores or slits in their extine (varying in number in different species), through which the intine protrudes itself as a tube, when the bulk of its contents has been increased by imbibition; it seems probable, however, that the extine is not absolutely deficient at these points, but is only thinned-away. Sometimes the pores are covered by little disk-like pieces or lids, which fall-off when the pollen-tube is protruded. This action takes place naturally when the pollen-grains fall upon the surface of the stigma, which is moistened with a viscid secretion; and the pollen-tubes, at first mere protrusions of the inner coat of their cell, insinuating themselves between the loosely-packed cells of the stigma, grow downwards through the style, sometimes even to the length of several inches, until they reach the ovarium. The first change—namely, the protrusion of the inner membrane through the pores of the

exterior—may be made to take place artificially by moistening the pollen with water, thin syrup, or dilute acids (different kinds of pollen-grains requiring different modes of treatment); but the subsequent extension by growth will only take place under the natural conditions. By treating some pollen-grains, as those of *Lilium Japonicum*, *L. rubrum*, or *L. auratum*, with the viscid liquid abundantly secreted by the stigma, not only may the extrusion and lengthening of the pollen-tubes be watched, but the grains with their extruded tubes may be preserved almost unchanged by mounting in this liquid.

388. The darker kinds of pollen may be generally rendered transparent by mounting in Canada balsam; or, if it be desired to avoid the use of heat, in the Benzole solution of Canada balsam (§ 205), setting aside the slide for a time in a warm place. For the less opaque pollens, the Dammar solution (§ 168, *d*) is preferable. The more delicate pollens, however, become too transparent in either of these media: and it is consequently preferable to mount them either dry or (if they will bear it without rupturing) in fluid. The most interesting forms are found, for the

most part, in plants of the orders *Amarantaceæ*, *Cichoraceæ*, *Cucurbitaceæ*, *Malvaceæ*, and *Passifloreæ*; others are furnished also by *Convolvulus*, *Campanula*, *Oenothera*, *Pelargonium* (Geranium), *Polygonum*, *Sedum*, and many other plants. It is frequently preferable to lay-down the entire anther, with its adherent pollen-grains (where these are of a kind that hold to it), as an opaque object; this may be done with great advantage in the case of the common Mallow (*Malva sylvestris*) or of the Hollyhock (*Althæa rosea*); the anthers being picked soon after they have opened, whilst a large proportion of their pollen is yet undischarged; and being laid down as flat as possible, before they have begun to wither, between two pieces of smooth blotting-paper, then subjected to moderate pressure, and finally mounted upon a black surface. They are then, when properly illuminated, most beautiful objects for objectives of 2-3ds. 1. 1½, or 2 in. focus, especially with the Binocular Microscope.<sup>1</sup>

389. The structure and development of the *ovules* that are produced within the ovarium at the base of the pistil, and the operation in which their fertilization essentially consists, are subject of investigation which have a peculiar interest for scientific Botanists, but which, in consequence of the special difficulties that attend the inquiry, are not commonly regarded as within the province of ordinary Microscopists.—Some general

<sup>1</sup> It sometimes happens that when the pollen of Pines or Firs is set free, large quantities of it are carried by the wind to a great distance from the woods and plantations in which it has been produced, and are deposited as a fine yellow dust, so strongly resembling Sulphur as to be easily mistaken for it. This (supposed) general diffusion of sulphur (such as occurred in the neighborhood of Windsor in 1879) has frightened ignorant rustics into the belief that the 'end of the world' was at hand. Its true nature is at once revealed by placing a few grains of it under the Microscope.

FIG. 277.

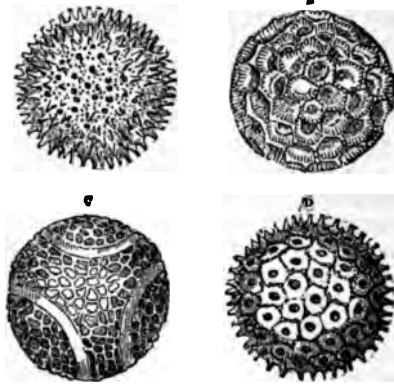

Pollen-grains of,—a, *Althæa rosea*; b, *Cobæa scandens*; c, *Passiflora cærulea*; d, *Ipomœa purpurea*.

Instructions, however, may prove useful to such as would like to inform themselves as to the mode in which the generative function is performed in plants. In tracing the origin and early history of the ovule, various sections should be made through the flower-bud, both vertically and transversely, and when the ovule is large and distinct enough to be readily examined, it should be placed on the thumb-nail of the left hand, and very thin sections made with a sharp razor; the ovule should be allowed to dry-up, and the section should be removed from the surface of the nail by a wetted camel-hair pencil. The tracing-downwards of pollen-tubes through the tissue of the style, may be accomplished by sections, which, however, will seldom follow one tube continuously for any considerable length, or, in some instances, by careful dissection with needles. Plants of the *Orchis* tribe are the most favorable subjects for this kind of investigation; which is best carried-on by artificially applying pollen to the stigma of several flowers, and then examining one or two of these styles daily. "If the style of flower of an *Epipactis* (says Johnston) on which the pollen has been applied about eight days previously, be examined in the manner above mentioned, the observer will be surprised to see an extraordinary number of pollen-tubes, and he will easily be able to trace them in large strings, even as far as the ovules. *Viola tricolor* (Heartsease), *Vitis nigra* and *rubra* (Black and Red Currant) are also good plants for the purpose; in the case of the former plant, withered flowers may be taken, and branched pollen-tubes will not unfrequently be met with." The entrance of the pollen-tube into the micropyle may be most easily observed in *Orchideous* plants and in *Euphrasia*; it being only necessary to tear-open with a needle the ovary of a flower which is just withering, and to detach from the placenta the ovules, almost every one of which will be found to have a pollen-tube sticking in its micropyle. These ovules, however, are too small to allow of sections being made, whereby the origin of the embryo may be discerned; and for this purpose, *Knautia* (Evening Primrose) has been had recourse to by Hoffmeister, whilst Schacht recommends *Lathræa squamaria*, *Pedicularis sylvatica*, and particularly *Pedicularis sylvatica*.

30. We have now, in the last place, to notice the chief points of interest to the Microscopist which are furnished by mature seeds. Many of the smaller kinds of these bodies are very curious, and some are very beautiful objects, when looked-at in their natural state under a low magnifying power. Thus the seed of the *Poppy* (Fig. 278, A) presents a regular reticulation upon its surface, pits for the most part hexagonal being left between projecting walls; that of *Caryophyllum* (D) is regularly covered with curiously jagged divisions, every one of which has a small bright black hemispherical knob in its middle, that of *Amaranthus hypochondriacus* has its surface traced with extremely delicate markings (B); that of *Linum catharticum* is strangely irregular in shape (C), and looks almost like a piece of furnace slag; and that of many *Bignoniaceæ* is remarkable for the beautiful reticulated structure of the translucent membrane which surrounds it (E). This structure is extremely well seen in the seed of the *Linum catharticum*, a half-hardy climbing plant now common in our gardens, and when its membranous 'wing' is examined under a sufficient magnifying power, it is found to be formed by an extraordinary elongation of the cells of the seed-coat at the margin of the seed, the side walls of which cells (those, namely, which lie in contact with one another) are thickened so as to form radiating ribs for the support of the wing, whilst the front and back walls (which constitute its membranous



surface) retain their original transparence, being marked only with an indication of spiral deposit in their interior. In the seed of *Dictyoloma Peruviana*, besides the principal 'wing' prolonged from the edge of the seed-coat, there is a series of successively smaller wings, whose margins form concentric rings over either surface of the seed; and all these wings are formed of radiating fibres only, composed, as in the preceding case, of the thickened walls of adjacent cells; the intervening membrane, originally formed by the front and back walls of these cells, having disappeared, apparently in consequence of being unsupported by any secondary deposit.<sup>1</sup> Several other seeds, as those of *Sphenogyne speciosa* and *Lophospermum erubescens*, possess wing-like appendages; but the most remarkable development of these organs is said by Mr. Quekett to exist in a seed of *Calosanthus Indica*, an East Indian plant, in which the wing extends more than an inch on either side of the seed.—Some seeds are distinguished by a peculiarity of form, which although readily discernible by the naked eye, becomes much more striking when they are viewed under a very low magnifying power: this is the case, for example, with the seeds of the *Carrot*, whose long radiating processes make it bear, under the Microscope, no trifling resemblance to some kinds of star-fish;

FIG. 27a.

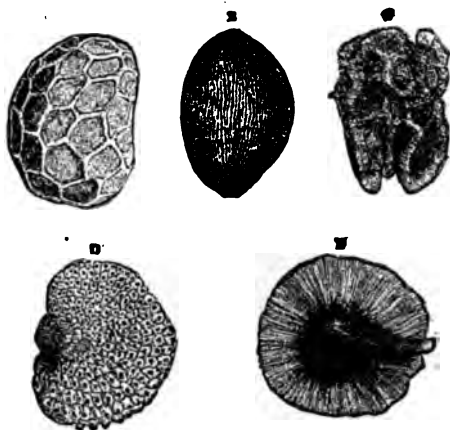

Seeds, as seen under a low magnifying power:—A, Poppy; B, *Amaranthus* (Prince's feather); *Antirrhinum majus* (Snap-dragon); D, *Caryophyllum* (Clove-pink); E, *Bignonia*.

and with those of *Cyanthus minor*, which bear about the same degree of resemblance to shaving-brushes. In addition to the preceding, the following may be mentioned as seeds easily to be obtained, and as worth mounting for opaque objects:—*Anagallis*, *Anethum graveolens*, *Begonia*, *Carum carui*, *Coreopsis tinctoria*, *Datura*, *Delphinium*, *Digitalis*, *Elatine*, *Erica*, *Gentiana*, *Gesnera*, *Hyoscyamus*, *Hypericum*, *Lepidium*, *Limnocharis*, *Linaria*, *Lychnis*, *Mesembryanthemum*, *Nicotiana*, *Ori-gamma onites*, *Orobanche*, *Petunia*, *Reseda*, *Saxifraga*, *Scrophularia*, *Sidum*, *Sempervivum*, *Silene*, *Stellaria*, *Symphytum asperrimum*, and *Verbena*. The following may be mounted as transparent objects in Canada balsam:—*Drosera*, *Hydrangea*, *Monotropa*, *Orchis*, *Parnassia*,

<sup>1</sup> See H. B. Brady in "Transactions of Microsc. Society," N.S., Vol. ix. (1861), p. 65.

*Pyrola, Saxifraga.*<sup>1</sup> The seeds of Umbelliferous plants generally are remarkable for the peculiar *vittæ*, or receptacles for essential oil, which are found in their coats. Various points of interest respecting the structure of the *testæ* or envelopes of seeds, such as the fibre-cells of *Cobaea* and *Collomia*, the stellate cells of the *Star-Anise*, and the densely-consolidated tissue of the 'shells' of the *Coquilla-nut*, *Cocoa-nut*, etc.,—having been already noticed, we cannot here stop to do more than advert to the peculiarity of the constitution of the husk of the *Corn-grains*. In these, as in other Grasses, the ovary itself continues to envelop the seed, giving a covering to it that surrounds its own testa, and closely adheres to it. The 'bran' detached in grinding consists not only of these two coats, but also (as the Microscope reveals) of an outer layer of the grain itself, formed of hexagonal cells disposed with great regularity. As these are filled with *gluten*, the removal of this layer takes away one of the most nutritious parts of the grain; and it is most desirable, therefore, that only the two outer indigestible coats should be detached by the 'decorticating' process devised for the purpose. The hexagonal cell-layer is so little altered by a high temperature, as still to be readily distinguishable when the grain has been ground after roasting,—thus enabling the Microscopist to detect even a small admixture of roasted Corn with Coffee or Chicory, without the least difficulty.<sup>2</sup>

---

<sup>1</sup> These lists have been chiefly derived from the "Micrographic Dictionary."

<sup>2</sup> In a case in which the Author was called upon to make such an investigation, he found as many as *thirty* distinctly-recognizable fragments of this cellular envelope, in a *single grain* of a mixture consisting of Chicory with only 5 per cent. of roasted Corn.



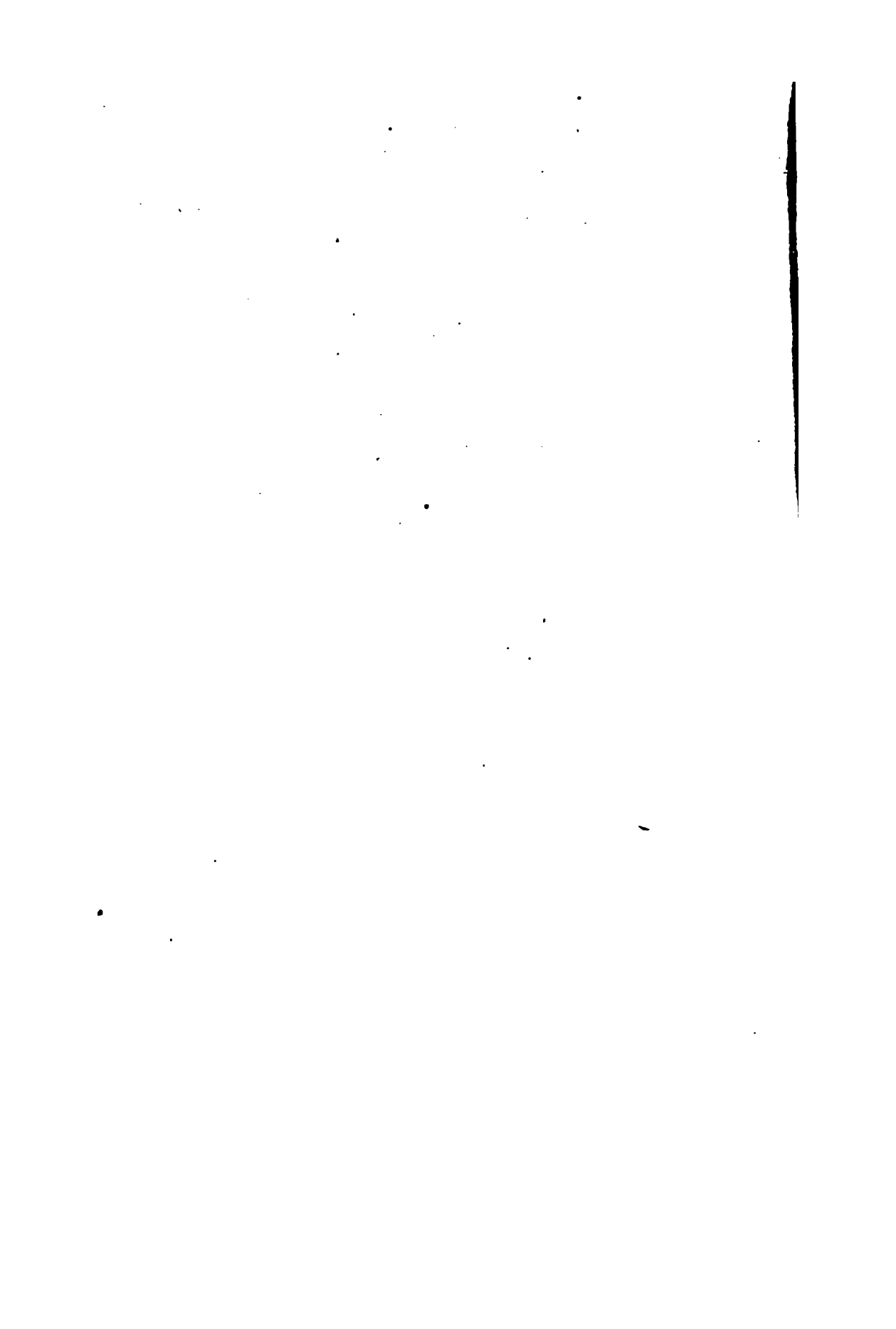



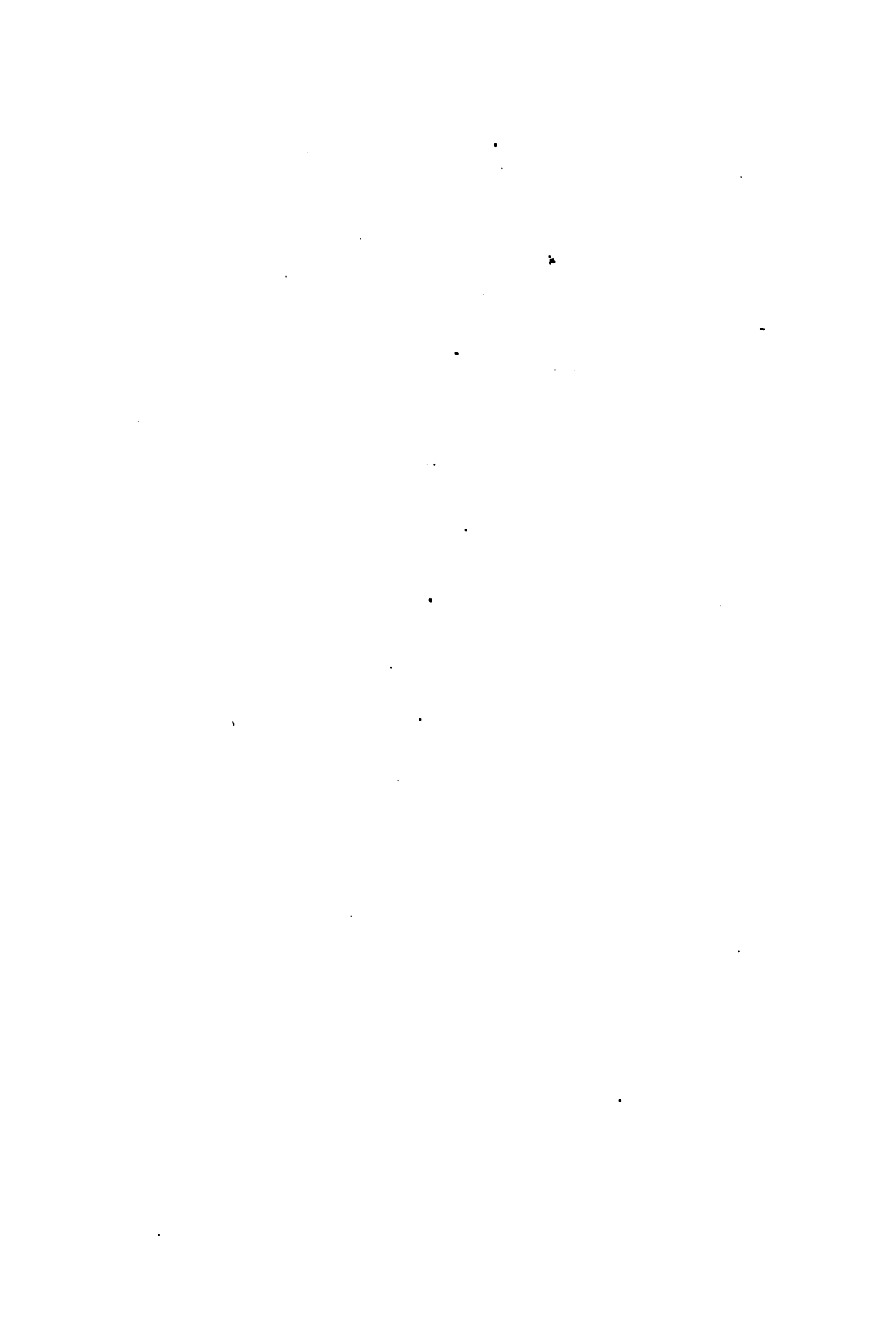

**LANE MEDICAL LIBRARY**

To avoid fine, this book should be returned  
on or before the date last stamped below.

---

**DEC 24 1999**

--	--



COOPER  
MEDICAL COLLEGE